

# Folk biology and the anthropology of science: Cognitive universals and cultural particulars

**Scott Atran**

Centre National de la Recherche Scientifique, CREA (Ecole Polytechnique),  
75005 Paris, France and

Institute for Social Research, The University of Michigan, Ann Arbor, MI  
48106–1248

Electronic mail: [satran@umich.edu](mailto:satran@umich.edu); [atran@poly.polytechnique.fr](mailto:atran@poly.polytechnique.fr)

**Abstract:** This essay in the “anthropology of science” is about how cognition constrains culture in producing science. The example is folk biology, whose cultural recurrence issues from the very same domain-specific cognitive universals that provide the historical backbone of systematic biology. Humans everywhere think about plants and animals in highly structured ways. People have similar folk-biological taxonomies composed of essence-based, species-like groups and the ranking of species into lower- and higher-order groups. Such taxonomies are not as arbitrary in structure and content, nor as variable across cultures, as the assembly of entities into cosmologies, materials, or social groups. These structures are routine products of our “habits of mind,” which may in part be naturally selected to grasp relevant and recurrent “habits of the world.” An experiment illustrates that the same taxonomic rank is preferred for making biological inferences in two diverse populations: Lowland Maya and Midwest Americans. These findings cannot be explained by domain-general models of similarity because such models cannot account for why both cultures prefer species-like groups, although Americans have relatively little actual knowledge or experience at this level. This supports a modular view of folk biology as a core domain of human knowledge and as a special player, or “core meme,” in the selection processes by which cultures evolve. Structural aspects of folk taxonomy provide people in different cultures with the built-in constraints and flexibility that allow them to understand and respond appropriately to different cultural and ecological settings. Another set of reasoning experiments shows that Maya, American folk, and scientists use similarly structured taxonomies in somewhat different ways to extend their understanding of the world in the face of uncertainty. Although folk and scientific taxonomies diverge historically, they continue to interact. The theory of evolution may ultimately dispense with the core concepts of folk biology, including species, taxonomy, and teleology; in practice, however, these may remain indispensable to doing scientific work. Moreover, theory-driven scientific knowledge cannot simply replace folk knowledge in everyday life. Folk-biological knowledge is not driven by implicit or inchoate theories of the sort science aims to make more accurate and perfect.

**Keywords:** anthropology; cognitive universals; culture; evolution; folk biology; Maya; modularity; taxonomy

## Introduction

In every human society, people think about plants and animals in the same special ways. These special ways of thinking, which can be described as “folk biology,” are fundamentally different from the ways humans ordinarily think about other things in the world, such as stones, stars, tools, or even people. The science of biology also treats plants and animals as special kinds of objects, but applies this treatment to humans, as well. Folk biology, which is present in all cultures, and the science of biology, whose origins are particular to Western cultural tradition, have corresponding notions of living kinds.

Consider four corresponding ways in which ordinary folk and biologists think of plants and animals as special. First, people in all cultures classify plants and animals into species-like groups that biologists generally recognize as populations of interbreeding individuals adapted to an ecological niche. We will call such groups – such as *redwood*, *rye*, *raccoon*, or *robin* – “generic species” for reasons that will become evident. Generic species are usually as obvious to a modern scientist as to local folk. Historically, the

generic-species concept provided a pretheoretical basis for scientific explanation of the organic world in that different theories – including evolutionary theory – have sought to account for the apparent constancy of “common species”



SCOTT ATRAN is a cognitive anthropologist at the Centre National de la Recherche Scientifique and Adjunct Professor of Psychology, Natural Resources and the Environment at The University of Michigan. He had taught in France, England, Israel and the USA and has published journal articles in anthropology, history of science, and psychology. He has extensive fieldwork in the Middle East and currently heads an interdisciplinary project on Lowland Maya natural history. With Douglas Medin, he is also co-directing a series of cross-cultural studies of biological categorization and reasoning and environmental decision making in North and Central America.

and for the organic processes that center on them (Wallace 1901, p. 1).

Second, there is a commonsense assumption that each generic species has an underlying causal nature, or essence, that is uniquely responsible for the typical appearance, behavior, and ecological preferences of the kind. People in diverse cultures consider this essence responsible for the organism's identity as a complex, self-preserving entity governed by dynamic internal processes that are lawful even when hidden. This hidden essence maintains the organism's integrity even as it causes the organism to grow, change form, and reproduce. For example, a tadpole and frog are in a crucial sense the same animal although they look and behave very differently, and live in different places. Western philosophers, such as Aristotle and Locke, attempted to translate this commonsense notion of essence into some sort of metaphysical reality, but evolutionary biologists reject the notion of essence as such. Nevertheless, biologists have traditionally interpreted this conservation of identity under change as the result of organisms having separate genotypes and phenotypes.

Third, in addition to the spontaneous division of local flora and fauna into essence-based species, such groups have "from the remotest period in . . . history . . . been classed in groups under groups. This classification [of generic species into higher- and lower-order groups] is not arbitrary like the grouping of stars in constellations" (Darwin 1883, p. 363).<sup>1</sup> The structure of these hierarchically included groups, such as *white oak/oak/tree* or *mountain robin/robin/bird*, is referred to as "folk-biological taxonomy." Especially in the case of animals, these nonoverlapping taxonomic structures can often be scientifically interpreted in terms of speciation (i.e., related species descended from a common ancestor by splitting off from a lineage).

Fourth, such taxonomies not only organize and summarize biological information, but they also provide a powerful inductive framework for making systematic inferences about the likely distribution of organic and ecological properties among organisms. For example, given the presence of a disease in robins, one is "automatically" justified in thinking that the disease is more likely to be present among other bird species than among nonbird species. In scientific taxonomy, which belongs to the branch of biology known as systematics, this strategy receives its strongest expression in "the fundamental principle of systematic induction" (Bock 1973; Warburton 1967). On this principle, given a property found among members of any two species, the best initial hypothesis is that the property is also present among all species that are included in the smallest higher-order taxon containing the original pair of species. For example, finding that the bacteria *Escherichia coli* shares a hitherto unknown property with robins, a biologist would be justified in testing the hypothesis that all organisms share the property. This is because *E. coli* link up with robins only at the highest level of taxonomy, which includes all organisms.

As we shall see, these four corresponding notions issue from a specific cognitive structure, which may be a faculty of the human mind that is innately and uniquely attuned to perceiving and conceptually organizing living kinds. The evolutionary origins of such a faculty arguably involved selection pressures bearing on immediate utility, such as obtaining food and surviving predators and toxins. In no society, however, do people exclusively classify plants and

animals because they are useful or harmful. This claim goes against the generally received view that folk biologies are primarily utilitarian, and that scientific biology emerged in part to expel this utilitarian bias from systematic thinking about the living world. Rather, the special ways people classify organic nature enable them to systematically relate fairly well delimited groups of plants and animals to one another in indefinitely many ways, and to make reasonable predictions about how biological properties are distributed among these groups, regardless of whether or not those properties are noxious or beneficial.

Although folk biology and the science of biology share a psychological structure, they apply somewhat different criteria of relevance in constructing and interpreting notions of species, underlying causal structure, taxonomy, and taxonomy-based inference. Given the universal character of folk biology, a plausible speculation is that it evolved to provide a generalized framework for understanding and appropriately responding to important and recurrent features in hominid ancestral environments. By contrast, the science of biology has developed to understand an organization of life in which humans play only an incidental role no different from other species. Thus, although there are striking similarities between folk taxonomies and scientific taxonomies, we will also find that there are radical differences. To explore how these different criteria of relevance function, the folk-biological taxonomies of American students and Maya Indians are compared and contrasted with scientific taxonomies.

In this target article, we first describe universal aspects of folk biology. We then show where and why folk biology and scientific biology converge and diverge. In the final part, we explain how folk biology and scientific biology continue to interact in the face of the historical differences that have emerged between them. The focus is on taxonomy and taxonomy-based inference. The general approach belongs to "the anthropology of science," which this article illustrates. The examples of biology do not apply straightforwardly to all of science, any more than those of systematics apply to all of biology, but they are central enough in the history of science to be a good place to begin.

## 1. Folk-biological taxonomy

More than a century of ethnobiological research has shown that even within a single culture there may be several different sorts of "special-purpose" folk-biological classifications that are organized by particular interests for particular uses (e.g., beneficial vs. noxious, domestic vs. wild, edible vs. inedible, etc.). Only in the last few decades has intensive empirical and theoretical work revealed a cross-culturally universal, "general-purpose" taxonomy (Berlin et al. 1973) that supports systematic reasoning about living kinds, and properties of living kinds, in the face of uncertainty (Atran 1990). For example, learning that one cow is susceptible to "mad cow" disease, one might reasonably infer that all cows are susceptible to the disease but not that all mammals or all animals are.

This "default" folk-biological taxonomy, which serves as an inductive compendium of biological information, is composed of a fairly rigid hierarchy of inclusive groups of organisms, or taxa. At each level of the hierarchy, the taxa, which are mutually exclusive, partition the locally perceived

biota in a virtually exhaustive manner. Lay taxonomy, it appears, is everywhere composed of a small number of absolutely distinct hierarchical levels, or ranks. Anthropologist Brent Berlin (1992) has established the standard terminology for folk-biological ranks as follows: the “folk-kingdom” rank (e.g., *animal*, *plant*), the “life-form” rank (e.g., *bug*, *fish*, *bird*, *mammal*, *tree*, *herb/grass*, *bush*), the “generic” or “generic-species” rank (e.g., *gnat*, *shark*, *robin*, *dog*, *oak*, *clover*, *holly*), the “folk-specific” rank (*poodle*, *white oak*), and the “folk-varietal” rank (*toy poodle*, *swamp white oak*). Taxa of the same rank tend to display similar linguistic, biological, and psychological characteristics.

### 1.1. The significance of rank

Rank allows generalizations to be made across classes of taxa at any given level. For example, the living members of a taxon at the generic-species level generally share a set of biologically important features that are functionally stable and interdependent (homeostasis); members can generally interbreed with one another but not with the living members of any other taxon at that level (reproductive isolation). Taxa at the life-form level generally exhibit the broadest fit (adaptive radiation) of morphology (e.g., skin covering) and behavior (e.g., locomotion) to habitat (e.g., air, land, water). Taxa at the subordinate folk-specific and folk-varietal levels often reflect systematic attempts to demarcate biological boundaries through cultural preferences.

The generalizations that hold across taxa of the same rank (i.e., a class of taxa) thus differ in logical type from generalizations that apply only to this or that taxon (i.e., a group of organisms). *Termite*, *pig*, and *lemon tree* are not related to one another by virtue of any simple relation of class inclusion or connection to some common hierarchical node, but by dint of their common rank – in this case the level of generic species. Notice that a system of rank is not simply a hierarchy, as some suggest (Carey 1996; Premack 1995; Rosch 1975). Hierarchy, that is, a structure of inclusive classes, is common to many cognitive domains, including the domain of artifacts. For example, *chair* often falls under *furniture* but not *vehicle*, and *car* falls under *vehicle* but not *furniture*. But there is no ranked system of artifacts:<sup>2</sup> no inferential link, or inductive framework, spans both *chair* and *car*, or *furniture* and *vehicle*, by dint of a common rank, such as the artifact *species* or the artifact *family*. In other words, in many domains there is hierarchy without rank, but only in the domain of living kinds is there always rank.

Ranks and taxa are of a different logical order, and confounding them is a category mistake. Biological ranks are second-order classes of groups (e.g., species, family, kingdom) whose elements are first-order groups (e.g., lion, feline, animal). Ranks seem to vary little, if at all, across cultures as a function of theories or belief systems. In other words, ranks are universal, but the taxa they contain are not. Ranks represent fundamentally different levels of reality, not convenience.

Consider: the most general rank is the folk kingdom,<sup>3</sup> that is, *plant* or *animal*. Such taxa are not always explicitly named but they represent the most fundamental divisions of the biological world. These divisions correspond to the notion of “ontological category” in philosophy (Donnellan 1971) and psychology (Keil 1979). From an early age humans cannot help but conceive of any object they see in the world as either being or not being an animal, and there is

evidence for an early distinction between plants and non-living things (Gelman & Wellman 1991; Hatano & Inagaki 1996; Hickling & Gelman 1995; Keil 1994). Conceiving of an object as a plant or animal seems to carry certain assumptions that are not applied to objects thought of as belonging to other ontological categories, like person, substance, or artifact.

The next rank down is that of life form.<sup>4</sup> The majority of taxa of lesser rank fall under one or another life form. Most life-form taxa are named by lexically unanalyzable names (primary lexemes), and have further named subdivisions, such as *tree* and *bird*. Biologically, members of a single life-form taxon are diverse. Psychologically, members of a life-form taxon share a small number of perceptual diagnostics, such as stem aspect, skin covering, and so forth (Brown 1984). Life-form taxa may represent general adaptations to broad sets of ecological conditions, such as competition among single-stem plants for sunlight and tetrapod adaptation to life in the air (Atran 1985a; Hunn 1982). Classification by life form may occur relatively early in childhood. For example, familiar kinds of quadrupeds (e.g., dogs and horses) are classified separately from sea versus air animals (Dougherty 1979 and Mandler et al. 1991 for American plants; Stross 1973 for Maya).

The core of any folk taxonomy is the rank of generic species, which contains by far the most numerous taxa in any folk-biological system. Taxa of this rank generally fall under some life form, but there may be outliers that are unaffiliated with any major life-form taxon.<sup>5</sup> This is often so for a plant or an animal of particular cultural interest, such as maize for Maya (Berlin et al. 1974) and the cassowary for the Karam of New Guinea (Bulmer 1970). Like life-form taxa, generic-species taxa are usually named by primary lexemes, such as *oak* and *robin*. Occasionally, generic-species names exhibit variant forms of what systematists refer to as binomial nomenclature: for example, binomial compounds, such as *hummingbird*, or binomial composites, such as *oak tree*. In both these cases the binomial makes the hierarchical relation apparent between the generic species and the life form.

Generic species often correspond to scientific genera or species, at least for those organisms that humans most readily perceive, such as large vertebrates and flowering plants. On occasion, generic species correspond to local fragments of biological families (e.g., *culture*), orders (e.g., *bat*), and, especially with invertebrates, even higher-order taxa (Atran 1987a; Berlin 1992). Generic species also tend to be the categories most easily recognized, most commonly named, and most readily learned in small-scale societies (Stross 1973).

Generic species may be further divided at the folk-specific level. Folk-specific taxa are usually labeled binomially, with secondary lexemes. Such compound names make transparent the hierarchical relation between a generic species and its subordinate taxa, like *white oak* and *mountain robin*. However, folk-specific taxa that belong to a generic species with a long tradition of high cultural salience may be labeled with primary lexemes, like *winesap* (a kind of apple tree) and *tabby* (a kind of cat). Partitioning into subordinate taxa usually occurs as a set of two or more taxa that contrast lexically along some readily perceptible dimension (color, size, etc.); however, such contrast sets often involve cultural distinctions that language and perception alone do not suffice to explain (Hunn 1982). An example is the Itzaj Maya

contrast between *red mahogany* (*chäk chäk-al-te'*) and *white mahogany* (*säk chäk-al-te'*). *Red mahogany* actually appears to be no redder than *white mahogany*. Rather, *red mahogany* is preferred for its beauty because it has a deeper grain than *white mahogany*. It is “red” as opposed to “white” probably because Lowland Maya traditionally associate red with the true wind of the East, which brings rain and bounty, and white with the false wind of the North, which brings deception (Atran, in press).

In general, whether or not a generic species is further differentiated depends on cultural importance. Occasionally, an important, folk-specific taxon will be further subdivided into contrasting folk-varietal taxa, such as *short-haired tabby* and *long-haired tabby*. Varietals are usually labeled trinomially, with tertiary lexemes that make transparent their taxonomic relationship with superordinate folk specifics and generic species. An example is *swamp white oak*.

Foreign organisms introduced into a local environment are often initially assimilated to generic species through folk-specific taxa. For example, European colonists originally referred to New World maize as “Indian corn,” that is, a kind of wheat. Similarly, Maya initially dubbed Old World wheat “Castillian maize.” Over time, as the introduced species acquired its own distinctive role in the local environment, it would assume generic-species status and would, as with most other generic species, be labeled by a single lexeme (e.g., “corn” in American English now refers exclusively to maize).

Finally, intermediate levels also exist between the generic-species and life-form levels. Taxa at these levels usually have no explicit name (e.g., rats + mice but no other rodents), although they sometimes do (e.g., felines, palms). Such taxa – especially unnamed “covert” ones – tend not to be as clearly delimited as generic species or life forms; nor does any one intermediate level always constitute a fixed taxonomic rank that partitions the local fauna and flora into a mutually exclusive and virtually exhaustive set of broadly equivalent taxa. Still, there is a psychologically evident preference for forming intermediate taxa at a level roughly between the scientific family (e.g., canine, weaver bird) and order (e.g., carnivore, passerine; Atran 1983; Berlin 1992).

### 1.2. The generic species: Principal focus of biological knowledge

People in all cultures spontaneously partition the ontological categories *animal* and *plant* into generic species in a virtually exhaustive manner. “Virtually exhaustive” means that when an organism is encountered that is not readily identifiable as belonging to a named generic species, it is still *expected* to belong to one. The organism is usually assimilated to one of the named taxa it resembles, although at times it is assigned an “empty” generic-species slot pending further scrutiny (e.g., “such-and-such a plant is some [generic-species] kind of tree;” see Berlin, in press). This partitioning of ontological categories seems to be part and parcel of the categories themselves: no plant or animal can fail, in principle, to belong uniquely to a generic species.

The term *generic species* is used here, rather than *folk general/folk generic* (Berlin 1972) or *folk species/folk specieme* (Bulmer 1970), for three reasons.<sup>6</sup>

1. A principled distinction between biological genus and species is not pertinent to most people around the world.

For humans, the most phenomenally salient species (including most species of large vertebrates, trees, and phylogenetically isolated groups such as palms and cacti) belong to monospecific genera in any given locale.<sup>7</sup> Closely related species of a polytypic genus are often hard to distinguish locally, and no readily perceptible morphological or ecological “gap” can be discerned between them (Diver 1940).

2. The term *generic species* reflects a more accurate sense of the correspondence between the most psychologically salient folk-biological groups and the most historically salient scientific groups (Stevens 1994a). The distinction between genus and species did not appear until the influx of newly discovered species from around the world compelled European naturalists to sort and remember them within a worldwide system of genera built around (mainly European) species types (Atran 1987a).

3. The term *generic species* reflects a dual character. As salient mnemonic groups, they are akin to genera in being those groups most readily apparent to the naked eye (Cain 1956). As salient causal groups, they are akin to species in being the principal centers of evolutionary processes responsible for biological diversity (Mayr 1969).

#### 1.2.1. The evolutionary sense of an essence concept.

From the standpoint of hominid evolution, the concept of such an essential kind may represent a balancing act between what our ancestors could and could not afford to ignore about their environment. The concept of generic species allows people to perceive and predict many important properties that link together the members of a biological species actually living together at any one time, and to distinguish such species from one another. By contrast, the ability to appreciate the graded phylogenetic relationships between scientific species, which involve vast expanses of geological time and geographical space, would be largely irrelevant to the natural selection pressures on hominid cognition.

Ernst Mayr (1969) calls such “local” species, which are readily observed over one or a few generations to coexist in a given local environment, “nondimensional species” for two reasons: they are manifest to the untrained eye, with no need for theoretical reflection, and the perceptible morphological, ecological, and reproductive gaps separating such species summarize the evolutionary barriers between them. Mayr argues that the awareness of nondimensional species provides the necessary condition for further insight and exploration into phylogenetic species; any sufficient condition for scientific understanding, however, must go beyond essentialism.

People ordinarily assume that the various members of each generic species share a unique underlying nature, or essence. This assumption carries the inference of a strong causal connection between superficially dissimilar or noncontiguous states or events – an inference that other animals or primates do not seem capable of making (cf. Kummer 1994). People reason that even three-legged, purring, albino tiger cubs are by nature large, striped, roaring, carnivorous quadrupeds. This is because there is presumably something “in” tigers that is the common cause of their growing large, having stripes, eating meat, and roaring under “normal” conditions of existence. People expect the disparate properties of a species to be integrally linked without having to know precise causal relationships.

A biological essence is an intrinsic (i.e., nonartificial)

teleological agent, which physically (i.e., nonintentionally) causes the biologically relevant parts and properties of a generic species to function and cohere “for the sake of” the generic species itself. For example, even preschoolers in our culture consistently judge that the thorns on a rose bush exist for the sake of there being more roses, whereas physically similar depictions of barbs on barbed wire or the protuberances of a jagged rock are not considered to exist for the sake of there being more barbed wire or jagged rocks (Keil 1994).

This concept of underlying essence goes against the claim that “biological essentialism is the theoretical elaboration of the logical-linguistic concept, substance sortal” that applies to every count noun (Carey 1996, p. 194). *Chair* may be defined in terms of the human function it serves, and *mud* in terms of its physical properties, but neither has deep essence because neither is necessarily assumed to be the unique outcome of an imperceptible causal complex. For example, a three-legged or legless beanbag chair does not lack “its” legs, because although most chairs “normally” have four legs, they are not quadrupedal by nature (cf. Schwartz 1978). Neither is the notion of essence merely that of a common physical property. *Red things* comprise a superficial natural class, but such things have little in common except that they are red; and they presumably have few, if any, features that follow from this fact.

People the world over assume that the initially imperceptible essential properties of a generic species are responsible for the surface similarities they perceive. People strive to know these deeper properties but also assume that the nature of a species may never be known in its entirety. This cognitive compulsion to explore the underlying nature of generic species produces a continuing and perhaps endless quest to better understand the surrounding natural world, even though such understanding seldom becomes globally coherent or consistent.

### 1.2.2. A taxonomic experiment on rank and preference.

Given these observations, cognitive studies of the “basic level” are at first sight striking and puzzling. In a justly celebrated set of experiments, Rosch and her colleagues set out to test the validity of the notion of a psychologically preferred taxonomic level (Rosch et al. 1976). Using a broad array of converging measures, they found that there is indeed a “basic level” in category hierarchies of “naturally occurring objects,” such as “taxonomies” of artifacts as well as living kinds. For artifact and living-kind hierarchies, the basic level is where: (1) many common features are listed for categories, (2) consistent motor programs are used for the interaction with or manipulation of category exemplars, (3) category members have similar enough shapes so that it is possible to recognize an average shape for objects of the category, and (4) the category name is the first one to come to mind in the presence of an object (e.g., “table” vs. “furniture” or “kitchen table”).

There is a problem, however. The basic level that Rosch et al. (1976) had hypothesized for artifacts was confirmed (e.g., *hammer*, *guitar*) but the hypothesized basic level for living kinds (e.g., *maple*, *trout*), which Rosch initially presumed would accord with the generic-species level, was not. For example, instead of *maple* and *trout*, Rosch et al. found that *tree* and *fish* operated as basic-level categories for American college students. Thus, Rosch’s basic level for living kinds generally corresponds to the life-form level,

which is superordinate to the generic-species level (cf. Zubin & Köpcke 1986 for findings with German).

To explore this apparent discrepancy between preferred taxonomic levels in small-scale and industrialized societies, and the cognitive nature of ethnobiological ranks in general, we use inductive inference. Although a number of converging measures have been used to explore the notion of basic levels, there has been little direct examination of the relationship between inductive inference and basic levels. This is all the more surprising in view of the fact that a number of psychologists and philosophers assume that basic-level categories maximize inductive potential as intuitive “natural kinds” that “scientific disciplines evolve to study” (Carey 1985, p. 171; cf. Gelman 1988; Millikan 1998). Inference studies allow us to test directly whether there is a psychologically preferred rank that maximizes the strength of any potential induction about biologically relevant information, and whether this preferred rank is the same across cultures. If a preferred level carries the most information about the world, then categories at that level should favor a wide range of inferences about what is common among members (cf. Anderson 1990).

The prediction is that inferences to a preferred category (e.g., *white oak* to *oak*, *tabby* to *cat*) should be much stronger than inferences to a superordinate category (*oak* to *tree*, *cat* to *mammal*). Moreover, inferences to a subordinate category (*swamp white oak* to *white oak*, *short-haired tabby* to *tabby*) should not be much stronger than or different from inferences to a preferred category. What follows is a summary of results from one representative set of experiments in two very diverse populations: Midwestern Americans and Lowland Maya (for complete results see Atran et al. 1997; Coley et al. 1997).

**1.2.2.1. Subjects and methods.** The Itzaj are Maya Amerindians living in the Petén rainforest region of Guatemala. Until recently, men devoted their time to shifting agriculture, hunting, and silviculture, whereas women concentrated on the myriad tasks of household maintenance. The Itzaj comprised the last independent native polity to be conquered by Spaniards (in 1697) and they have preserved virtually all ethnobiological knowledge recorded for Lowland Maya since the time of the initial Spanish conquest (Atran 1993). Despite the current awesome rate of deforestation and the decline of Itzaj culture, the language and ethic of traditional Maya silviculture is still very much in evidence among the generation of our informants who range in age from 50 to 80 years old. The Americans were self-identified as people raised in Michigan and recruited through an advertisement in a local newspaper.

Based on extensive fieldwork with the Itzaj, we chose a set of Itzaj folk-biological categories of the kingdom (K), life-form (L), generic-species (G), folk-specific (S), and folk-varietal (V) ranks. We selected three plant life forms: *che'* = tree, *ak'* = vine, *pok~che'* = herb/bush. We also selected three animal life forms: *b'a'al~che'* *kuxi'mal* = “walking animal,” that is, mammal, *ch'üch'* = birds, including bats, *käy* = fish. Three generic-species taxa were chosen from each life form such that each generic species had a subordinate folk-specific, and each folk-specific had a salient varietal.

Pretesting showed that participants were willing to make inferences about hypothetical diseases. The properties chosen for animals were diseases related to the “heart”

(*pusik'al*), “blood” (*k'ik'el*), and “liver” (*tamen*). For plants, diseases related to the “roots” (*motz*), “sap” (*itz*), and “leaf” (*le'*). Properties were chosen according to Itzaj beliefs about the essential, underlying aspects of life’s functioning. Thus, the Itzaj word *pusik'al*, in addition to identifying the biological organ “heart” in animals, also denotes “essence” or “heart” in both animals and plants. The term *motz* denotes “roots,” which is considered the initial locus of the plant *pusik'al*. The term *k'ik'el* denotes “blood” and is conceived as the principal vehicle for conveying life from the *pusik'al* throughout the body. The term *itz* denotes “sap,” which functions as the plant’s *k'ik'el*. The *tamen*, or “liver,” helps to “center” and regulate the animal’s *pusik'al*. The *le'*, or “leaf,” is the final locus of the plant *pusik'al*. Properties used for inferences had the form, “is susceptible to a disease of the (root) called (X).” For each question, “X” was replaced with a phonologically appropriate nonsense name (e.g., “eta”) to minimize the task’s repetitiveness.

All participants responded to a list of more than 50 questions in which they were told that all members of a category had a property (the premise) and were asked whether “all,” “few,” or “no” members of a higher-level category (the conclusion category) also possessed that property. The premise category was at one of four levels, either life-form (e.g., L = bird), generic-species (e.g., G = vulture), folk-specific (e.g., S = black vulture), or varietal (e.g., V = red-headed black vulture). The conclusion category was drawn from a higher-level category, either kingdom (e.g., K = animal), life-form (L), generic-species (G), or folk-specific (S). As a result, there were 10 possible combinations of premise and conclusion category levels: L → K, G → K, G → L, S → K, S → L, S → G, V → K, V → L, V → G, and V → S. For example, a folk-specific-to-life form (S → L) question might be, “If all black vultures are susceptible to the blood disease called eta, are all other birds susceptible?” If a participant answers no, then the follow-up question would be, “Are some or a few other birds susceptible to disease eta, or no other birds at all?”

The corresponding life forms for the Americans were: mammal, bird, fish, tree, bush, and flower (on flower as an American life form see Dougherty 1979). The properties used in questions for the Michigan participants were “have protein X,” “have enzyme Y,” and “are susceptible to disease Z.” These were chosen to be internal, biologically based properties intrinsic to the kind in question, but abstract enough so that rather than answering what amounted to factual questions, participants would be likely to make inductive inferences based on taxonomic category membership.

**1.2.2.2. Results.** Representative findings are given in Figure 1. Responses were scored in two ways. First we totaled the proportion of “all or virtually all” responses for each kind of question (e.g., the proportion of times respondents agreed that if red oaks had a property, all or virtually all oaks would have the same property). Second, we calculated “response scores” for each item, counting a response of “all or virtually all” as 3, “some or few” as 2, and “none or virtually none” as 1. A higher score reflected more confidence in the strength of an inference.

Figure 1a summarizes the results from all Itzaj informants for all life forms and diseases, and shows the proportion of “all” responses (black), “few” responses (checkered), and “none” responses (white). For example, given a

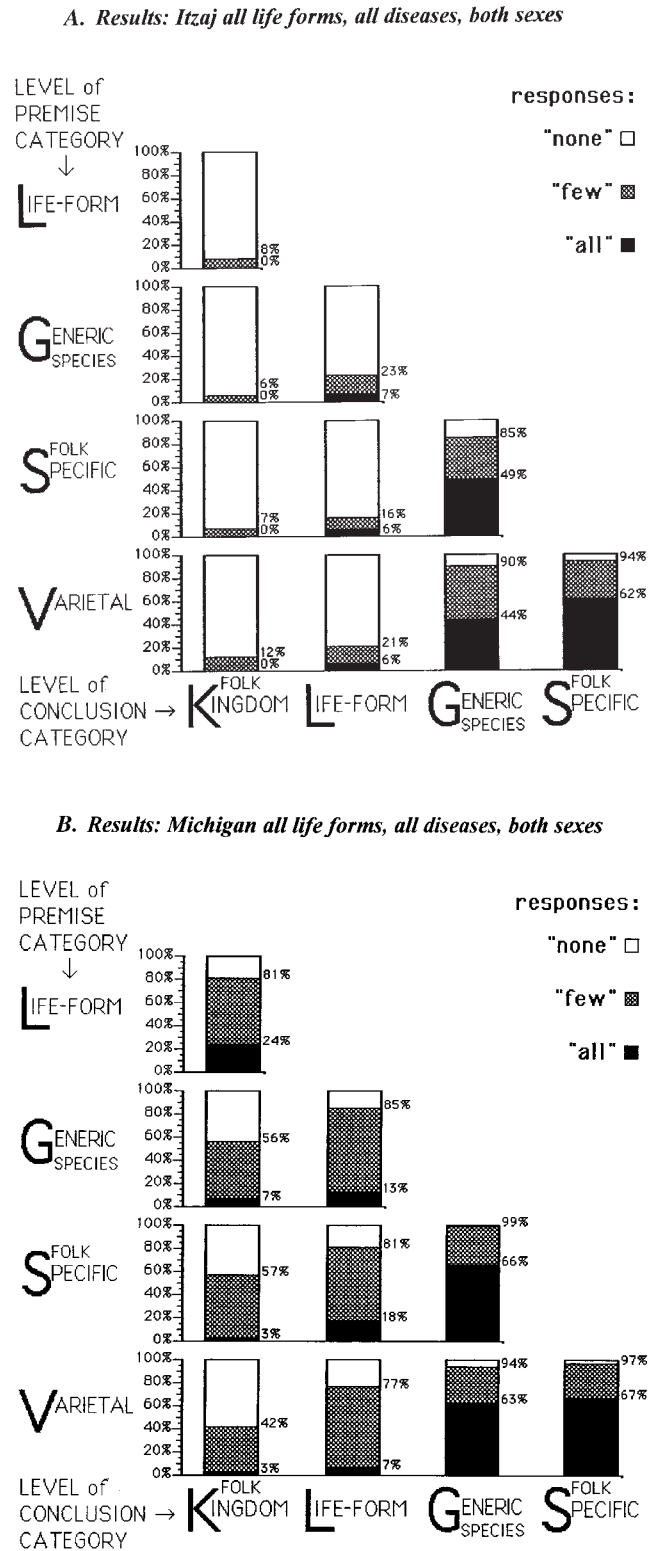

Figure 1. Rank and inference: comparing the willingness of Itzaj Maya and Michigan students to make inductions across folk-biological ranks. Results include all life forms and biological properties, showing the proportion of “all” (black), “few” (checkered), and “none” responses (white). Main diagonals represent inferences from a given rank (premise category) to the adjacent higher-order rank (conclusion category): V(arietal) → S(pecific), S(pecific) → G(eneric species), G(eneric species) → L(ife form), L(ife form) → K(ingdom). Moving horizontally within each graph corresponds to holding the premise constant and varying the conclusion: e.g., V → S, V → G, V → L, V → K.

premise of folk-specific (S) rank (e.g., red squirrel) and a conclusion category of generic-species (G) rank (e.g., squirrel), 49% of responses indicated that “all” squirrels, and not just “some” or “none,” would possess a property that red squirrels have. Results were obtained by totaling the proportion of “all or virtually all” responses for each kind of question (e.g., the proportion of times respondents agreed that if red oaks had a property, all or virtually all oaks would have the same property). A higher score represented more confidence in the strength of the inductive inference. Figure 1b summarizes the results of Michigan response scores for all life forms and biological properties.

Response scores were analyzed using t-tests with significance levels adjusted to account for multiple comparisons. Figure 2 summarizes the significant comparisons (*p* values) for “all” responses, “none” responses, and combined responses. For all comparisons, *n* = 12 Itzaj participants and *n* = 21 American participants (for technical details see Atran et al. 1997).

Following the main diagonals of Figures 1 and 2 refers to changing the levels of both the premise and conclusion categories while keeping their relative level the same (with the conclusion one level higher than the premise). Induction patterns along the main diagonal indicate a single inductively preferred level. Examining inferences from a given rank to the adjacent higher-order rank (i.e., V → S, S → G, G → L, L → K), we find a sharp decline in strength of in-

ferences to taxa ranked higher than generic species, whereas V → S and S → G inferences are nearly equal and similarly strong. Notice that for “all” responses, the overall Itzaj and Michigan patterns are nearly identical.

Moving horizontally within each graph in Figures 1 and 2 corresponds to holding the premise category constant and varying the level of the conclusion.<sup>8</sup> Here we find the same pattern for “all” responses for both Itzaj and Americans as we did along the main diagonal. However, in the combined response scores (“all” + “few”) there is now evidence of increased inductive strength for higher-order taxa among Americans versus Itzaj. On this analysis, both Americans and Itzaj show the largest break between inferences to generic species versus life forms. But only American subjects also show a consistent pattern of rating inferences to life-form taxa higher than to taxa at the level of the folk kingdom: G → K versus G → L, S → K versus S → L, and V → K versus V → L.

Finally, moving both horizontally and along the diagonal, for Itzaj there is some hint of a difference between inductions using conclusions at the generic-species versus folk-specific levels: V → G and S → G are modestly weaker than V → S. Regression analysis reveals that for Itzaj, the folk-specific level accounts for a small proportion of the variance beyond the generic species (1.4%), but a significant one (*F* > 4). For Michigan participants, the folk-specific level is not differentiated from the generic-species level (0.2, not significant). In fact, most of the difference between V → G and V → S inductions results from inference patterns for the Itzaj tree life form. There is evidence that Itzaj confer some preferential status on trees at the folk-specific level (e.g., savanna nance tree). Itzaj are forest-dwelling Maya with a long tradition of agroforestry that antedates the Spanish conquest (Atran 1993; Atran & Ucan Ek', in press).

**Results: Representations of significant comparisons between adjacent cells**

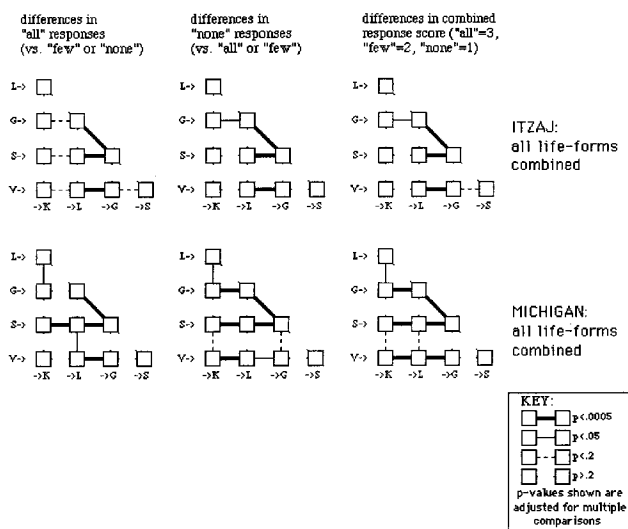

Figure 2. Significant comparisons between adjacent categories in the rank and inference task for Itzaj Maya and Michigan students. Results include all life forms and biological properties, showing “all” (versus “few” or “none”), “none” (versus “all” or “few”), and combined responses (“all” = 3, “few” = 2, “none” = 1). Main diagonals represent inferences from a given rank (premise category) to the adjacent higher-order rank (conclusion category): V(arietal) → S(pecific), S(pecific) → G(eneric species), G(eneric species) → L(ife form), L(ife form) → K(ingdom). Moving horizontally within each graph corresponds to holding the premise constant and varying the conclusion: e.g., V → S, V → G, V → L, V → K.

**1.2.2.3. Discussion.** These results indicate that both the ecologically inexperienced Americans and the ecologically experienced Itzaj prefer taxa of the generic-species rank in making biological inferences; the findings go against a simple relativist account of cultural differences in folk-biological knowledge. However, the overall effects of cultural experience on folk-biological reasoning are reflected in more subtle ways that do not undermine an absolute preference for the generic species across cultures. In particular, the data point to a relative downgrading of inductive strength to higher ranks among industrialized Americans through knowledge attrition owing to a lack of experience and a relative upgrading of inductive strength to lower ranks among silvicultural Maya through expertise.

A secondary reliance on life forms is arguably the result of Americans’ general lack of actual experience with generic species (Dougherty 1978). In one study, American students used only the name “tree” to refer to 75% of the species they saw in a nature walk (Coley et al. 1997). Although Americans usually cannot tell the difference between beeches and elms, they *expect* that biological action in the world is at the level of beeches and elms and not tree. Yet without being able at least to recognize a tree, they would not even know where to begin to look for the important biological information. The Itzaj pattern reflects both overall preference for generic species and the secondary importance of lower-level distinctions, at least for kinds of trees. A strong ethic of reciprocity in silviculture still pervades the Itzaj; the Maya tend trees so that the forest will

tend to the Maya (Atran & Medin 1997). This seems to translate into an upgrading of biological interest in tree folk-specifics.

These findings cannot be explained by appeals either to cross-domain notions of perceptual “similarity” or to the structure of the world “out there.” On the one hand, if inferential potential were a simple function of perceptual similarity, then Americans should prefer life forms for induction (in line with Rosch et al. 1976). Yet Americans prefer generic species as do Maya. On the other hand, objective reality – that is, the actual distribution of biological species within groups of evolutionarily related species – does not substantially differ in the natural environments of Midwesterners and Itzaj. Unlike Itzaj, however, Americans perceptually discriminate life forms more readily than generic species. True, there are more locally recognized species of tree in the Maya area of Peten, Guatemala than in the Midwest United States. Still, the readily perceptible evolutionary “gaps” between species are roughly the same in the two environments (most tree genera in both environments are monospecific). If anything, one might expect that having fewer trees in the American environment allows each species to stand out more from the rest (Hunn 1976). For birds the relative distribution of evolutionarily related species also seems to be broadly comparable across temperate and rainforest environments (Boster 1988).

An inadequacy in current accounts of preferred taxonomic levels may be a failure to distinguish domain-general mechanisms for best clustering stimuli from domain-specific mechanisms for best determining loci of biological information. To explain Rosch’s (1975) data it may be enough to rely on domain-general, similarity-based mechanisms. Such mechanisms may generate a basic level in any number of cognitive domains, but not the preferred level of induction in folk biology.

Perhaps humans are disposed to take tight clusters of covariant perceptual information as strong indicators of a rich underlying structure of biological information. This may be the “default” case for humans under “normal” conditions of learning and exposure to the natural world. By and large, people in small-scale societies would live under such “normal” conditions, involving the same general sorts of ambient circumstances that led to the natural selection of cognitive principles for the domain of folk biology. People in urban societies, however, may no longer live under such “default” conditions (except for hunters, bird watchers, etc.; Tanaka & Taylor 1991).

How, then, can people conceive of a given folk-biological category as a generic species without always (or mostly) relying on perception? Ancillary encyclopedic knowledge may be crucial. Thus, one may have detailed knowledge of dogs but not oaks. Yet a story that indicates where an oak lives, or how it looks or grows, or that its life is menaced may be sufficient to trigger the assumption that oaks comprise a generic species just as dogs do. But such cultural learning produces the same results under widely divergent conditions of experience in different social and ecological environments. This indicates that the learning itself is strongly motivated by cross-culturally shared cognitive mechanisms that do not depend primarily on experience.

In conjunction with encyclopedic knowledge of what is already known for the natural world, language is important in targeting preferred kinds. In experiments with children as young as 2 years old, Gelman and her colleagues showed

that sensitivity to nomenclatural patterns and other linguistic cues helps guide folk-biological inferences about information that is not perceptually obvious, especially for categories believed to embody an essence (Gelman et al. 1994; Hall & Waxman 1993). Language alone, however, is not enough to induce the expectation that little-known generic species convey more biological information than better-known life forms for Americans. Some other process must invest the generic-species level with inductive potential. Language alone can only signal that such an expectation is appropriate for a given lexical item; it cannot determine the nature of that expectation.

Why assume that an appropriately tagged item is the locus of a “deep” causal nexus of biological properties and relationships? It is logically impossible that such assumptions and expectations come from (repeated exposure to) the stimuli themselves. Input to the mind alone cannot cause an instance of experience (e.g., a sighting in nature or in a picture book), or any finite number of fragmentary instances, to be generalized into a category that subsumes a rich and complex set of indefinitely many instances. This projective capacity for category formation can only come from the mind, not from the world alone.

The empirical question, then, is whether or not this projective capacity of the mind is simply domain-general or also domain-specific. For any given category domain – say, living kinds as opposed to artifacts or substances – the process would be domain-general if and only if one could generate the categories of any number of domains from the stimuli alone, together with the very same cognitive mechanisms for associating and generalizing those stimuli. But current domain-general similarity models of category formation and category-based reasoning fail to account for the generic species as a preferred level for folk-biological taxonomy across cultures.

Our findings suggest that fundamental categorization processes in folk biology are rooted in domain-specific conceptual assumptions rather than in domain-general perceptual heuristics. Subsistence cultures and industrialized cultures may differ in the level at which organisms are most easily identified, but they both still believe that the same absolute level of reality is preferable for biological reasoning, namely, the generic-species rank. This is because they expect the biological world to partition at that rank into nonoverlapping kinds, each with its own unique causal essence, whose visible products may or may not be readily perceived.

People anticipate that the biological information value of these preferred kinds is maximal, whether or not there is also a visible indication of maximal covariation of perceptual attributes. This does not mean that more general perceptual cues have no inferential value when applied to the folk-biological domain. On the contrary, the evidence points to a significant role for such cues in targeting basic-level life forms as secondary foci for inferential understanding in a cultural environment where biological awareness is relatively poor, as among many Americans. Possibly there is an evolutionary design to having both domain-general perceptual heuristics and domain-specific learning mechanisms: the one enabling flexible adaptation to the variable conditions of experience, the other more invariable in steering us to those abiding aspects of biological reality that are causally recurrent and especially relevant for the emergence of human life and cognition.



### 1.3. Evolutionary ramifications: Folk biology as a core domain of mind and culture.

A speculative but plausible claim in light of our observations and findings is that folk biology is a core domain for humans. A core domain is a semantic notion, philosophically akin to Kant's "synthetic a priori." The object domain, which consists of generic species of biological organisms, is the extension of an innate cognitive module. Universal taxonomy is a core module, that is, an innately determined cognitive structure that embodies the naturally selected ontological commitments of human beings and provides a domain-specific mode of causally construing the phenomena in its domain (for a more disembodied view of innate "modes of construal," see Keil 1995). In particular, the cognitive structure of folk biology specifies that generic species are the preferred kinds of things that partition the biological world, that these generic species are composed of causally related organisms that share the same vitalist (teleo-essentialist) structure, and that these generic species further group together into causally related but mutually exclusive groups under groups. In sum, the generic species is a core concept of the folk-biology module.

Core modules share much with Fodor's (1983) input modules. Both are presumably naturally selected endowments of the human mind that are initially activated by a predetermined range of perceptual stimuli. However, there are differences. Input modules, unlike core modules, are hermetically closed cognitive structures that have exclusive access to the mental representations that such input systems produce. For example, syntactic-recognition schemata and facial-recognition schemata, respectively, deal exclusively and entirely with syntactic recognition and facial recognition. By contrast, core modules have preferential rather than proprietary access to their domain-specific representations (Atran 1990, p. 285). For example, core modules for naive physics, intuitive psychology, or folk biology can make use of one another's inputs and outputs, although each module favors the processing of a different predetermined range of stimuli.

Moreover, the ability to use a "metarepresentational module," which takes as inputs the outputs of all other modules, allows changes (restructurings and extensions) to operate over the initial core domain as a result of developing interactions with our external (ambient) and internal (cognitive) environment. Flexibility in core modules, Sperber (1994) argues, makes evolutionary sense of how humans so quickly acquire distinct sorts of universal knowledge, which individuals and cultures can then work on and modify in various ways. Sperber's discussion also indicates, in principle, how ordinary people and cognitive scientists can manage the "combinatorial explosion" in human information without simply making it all grist for an inscrutable central-processing mill.

A living kind module enables humans to apprehend the biological world spontaneously as a partitioning into essence-based generic species and taxonomically related groups of generic species. This directs attention to interrelated and mutually constraining aspects of the plant and animal world, such as the diverse and interdependent functioning of heterogeneous body parts, maturational growth, inheritance and natural parentage, disease, and death. Eventually, coherent "theories" of these causal interrelations might develop under particular learning conditions

(Carey 1985) or historical circumstances (Atran 1990). Such systematic elaboration of biological causality, however, is not immediately observable or accessible.

Core knowledge that is domain-specific should involve dedicated perceptual-input analyzers, operating with little interference or second-guessing from other parts of the human conceptual system (Carey 1996; Gigerenzer, in press). What might be the evolutionary algorithm that activates or triggers the living kind module's selective attention to generic species? In the absence of experiments or other reliable data, we can only speculate. Evidence from other core domains, such as naive physics and intuitive psychology, helps as both guide and foil to speculation about triggering algorithms for a living-kind module. For humans as well as animals, there is some evidence of at least two distinct but hierarchically related triggering algorithms, each involving a dedicated perceptual-input-analyzer that attends to a restricted range of information.

There is an algorithm that attends only to the external movements of rigid bodies that obey something like the laws of Newtonian mechanics in a high-friction environment. Thus, infants judge that an object moving on a plane surface will continue along that surface in a straight path until it stops, but will not jump and suspend itself in midair (Spelke 1990). There is also an algorithm that attends to the direction and acceleration of objects not predictable by "naive mechanics." If the motion pattern of one object on a computer screen centers on the position of another object, so that the first object circles around the second object, and speeds up toward or away from it, then infants judge the first object to be self-propelled or "animate" (Premack & Premack 1994).

Of course, algorithms for animateness and intentionality can lead to mistakes. They surely did not evolve in response to selection pressures involving two-dimensional figures moving across computer screens. These inhabitants of flatland just happen to fall within the actual domains to which the modules for animacy and intentionality spontaneously extend, as opposed to the proper domains for which the modules evolved (i.e., animate beings and intentional agents). Much as the actual domain of frog food-getting intelligence involves tongue flicking at dark points passing along a frog's field of vision, whereas the proper domain is more about catching flies (Sperber 1994).

Algorithms for animacy and intentionality do not suffice to discriminate just living kinds, that is, generic species. On the one hand, they fail to distinguish plants from nonliving kinds. Yet people everywhere distinguish plants into generic species just as they do animals. An algorithm that cues in primarily on the relative movement of heterogeneous and diversely connected parts around an object's center of gravity probably plays an important role in discerning animals and plants (perhaps first as they move in the wind, then grow, etc.), although it too may initially err (plastic plants, perhaps clothes on a line). On the other hand, algorithms for animacy and intentionality fail to distinguish humans from nonhuman living kinds, that is, plants and animals.

It is animals and plants that are always individuated in terms of their unique generic species, whereas humans are individuated as both individual agents and social actors in accordance with inferred intentions rather than expected clusters of body parts. People individuate humans (as opposed to animals) with the additional aid of a variety of

domain-specific “recognizers” for individual human faces, voices, gestures, and gaits, which richly motivate inferences about motion and intention from rather partial and fleeting perceptual cues (Fodor 1983; Tooby & Cosmides 1992). Yet no known aboriginal culture – or any culture not exposed to Aristotle – believes that humans are animals in that there is an ontological category undifferentiated between humans and animals.

Let us further speculate about selection pressures involved in our automatic attention to human individuals versus our automatic attention to generic species. A characteristic of primates (and some other vertebrates) is that they are social animals who can distinguish individuals of their species, unlike termites who cannot (Kummer et al., in press). There is evidence that as long as 2 million years ago, *Homo habilis* relied on nonkin to hunt, gather, and scavenge for subsistence (Isaac 1983). To handle the social contracts required for this mode of subsistence, coalition forming and cooperation with nonkin were probably required. This probably entailed a negotiation of intentions with individuals who could not be identified by indications of blood relationship.

In regard to animals and plants, there is also evidence of varied and wide-ranging diet and subsistence patterns in hominid social camps at that time (Bunn 1983). In such a camp, it could be supremely important to know which individual should be recruited in a food-sharing coalition if only to avoid “free riders” who take without giving (Cosmides & Tooby 1989). But it would hardly matter to know the individual identity of lions that could eat you, nettles that could sting you, or deer and mangos you could eat. Knowing not just the habits of particular species, but making taxonomic inferences about the habits and relationships of groups of biologically related species would be likely to increase the effectiveness (benefit) of such knowledge-based subsistence immeasurably, with little or no added investment (cost) in time or effort (trial-and-error learning).

The special evolutionary origins of domain-specific cognitive modules should have special bearings on cultural evolution. One might have expected the implications of domain specificity to be compelling for those who reason in line with Dawkins (1976), viewing the emergence of culture as a selection process. Unfortunately, aside from notable exceptions (cf. Lumsden & Wilson 1981; Sperber 1994; Tooby & Cosmides 1992), the focus is primarily on how, for example, “Chinese minds differ radically from French minds” (Dennett 1995, p. 365; cf. Cavalli-Sforza & Feldman 1981; Durham 1991). Nevertheless, Dawkins’s idea may be good for the study of human cultures, suitably modified by the findings and concerns of cognitive anthropology. His idea is that there may be cultural units that function in social evolution just as there are biological units that function in biological evolution. He calls these units of cultural transmission “memes” – a word that sounds like “gene” and evokes Latin and Greek words for “imitation.” One modification consists of restricting highly imitative, replicating memes to knowledge produced by core domains, that is, to memes that have an identifiable syntactic as well as a semantic aspect. In this respect, folk-biological knowledge is a core meme.

A core meme, like universal taxonomy, differs from a developing meme, like the culturally specific elaboration of a scientific research program, in a number of interrelated ways. An apparent difference is in the closer resemblance of

core memes to genes. First, for core memes, like genes, there is a strong alignment of syntactic (“genotypic”) and semantic (“phenotypic”) identity. For example, the universal structure of folk-biological taxonomy arguably emerges from a modular cognitive capacity – a mental faculty – that evolved as an effective means of capturing perceptibly relevant and recurrent aspects of ancestral hominid environments.

As a result, humans “conceptually perceive” the biological world in more or less the same way. Processes of perceiving and reasoning about generic species are intimately connected, they are guided by the same knowledge system. The folk-biology module focuses attention on perceptual information that can reveal that an object is a living kind, or organism, by uniquely assigning it to one or another of the fundamental partitions of the readily perceptible biological world. Thus, the key feature of folk biology, belonging to a preferred taxonomic rank and a causally essential category, is induced from spatiotemporal analysis via a triggering algorithm that attends to a limited set of perceptual cues whose presence signals an organism as belonging to a generic species.

Second, for core memes, conceptual replication involves information being physically transmitted largely intact from physical vehicle to physical vehicle without any appreciable sequencing of vehicles. As in genetic replication, replication of core memes involves fairly high-fidelity copying and a relatively low rate of mutation and recombination. Mental representations of generic species, for example, are transmitted from brain to brain via public representations such as uttered names and pointings (Sperber 1985). It often suffices, however, that a single fragmentary instance of experience – a naming or sighting by ostension in a natural or artificial setting – “automatically” triggers the transmission and projection of that instance into a richly structured taxonomic context (Atran & Sperber 1991).

By contrast, a developing meme requires institutionalized channeling of information. For example, specific scientific schools or research programs involve more or less identifiable communities of scientists, journals, instruments, laboratories, and so forth. Institutionalization is necessary because the information is harder to learn and keep straight, but is also more readily transformed and extended into new or different knowledge. This often requires formal or informal instruction to sustain the sequencing of information, and to infuse output with added value by inciting or allowing transformation of input via interpolation, invention, selection, suppression, and so forth (see Hull 1988 and Latour 1987 for different insights into institutional constraints).

Third, a core meme does not depend for its survival on the cognitive division of labor in a society or on durable transmission media. For example, children can learn about species from written texts, films, or picture books; nevertheless, noninstitutionalized transmission of such information in an illiterate society is usually quite reliable as long as there is an unbroken chain of oral communication (within the living memory of the collective) about events in the natural world. Developing memes, however, typically mobilize information of such quantity, diverse quality, and expertise that single minds cannot – for lack of capacity or because of other cognitive demands – keep track of all that is needed to understand the information and pass it along. Because scientists can usually only work on bits and pieces of

the information in the field at any particular time and place, but may also need to consult information elaborated elsewhere or left fallow for generations (e.g., Mendel's discoveries), durable media are required for that information to endure usefully.

Fourth, a core meme does not primarily depend on metacognitive abilities, although it may make use of them (e.g., in stories, allegories, analogies). For the harder-to-learn beliefs of developing memes to grow requires the mingling of ideas from different sources, including different sorts of core memes. For example, numerical and mechanical knowledge now play important, and perhaps preponderant, roles in areas of molecular biology. Mingling of ideas implies the transfer of diverse domain-specific outputs into a domain-neutral representation. A domain-neutral metarepresentation can then function as input for further information processing and development.

Fifth, the involvement of core memes in developing metacognitive memes that ride piggyback on core memes or stem from them, such as totemism or biological systematics, allows us, in principle, to distinguish the convergent evolution of memes across cultures from borrowing, diffusion, and descent. If all memes were purely semantic, such a distinction might well be practically impossible in the absence of clear historical traces. One case of convergent evolution is the spontaneous emergence of totemism – the correspondence of social groups with generic species – at different times and in different parts of the world. Why, as Lévi-Strauss (1963) aptly noted, are totems so “good to think”? In part, totemism is metacognitive because it uses representations of generic species to represent groups of people; however, this pervasive metarepresentational inclination arguably owes its recurrence to its ability to ride piggyback on folk-biological taxonomy, which is not primarily or exclusively metacognitive.

Consider: generic species and groups of generic species are inherently well structured, attention-arresting, memorable, and readily transmissible across minds. As a result, they readily provide effective pegs on which to attach knowledge and behavior of less intrinsically well-determined social groups. In this way totemic groups can also become memorable, attention-arresting, and transmissible across minds. These are the conditions for any meme to become culturally viable (see Sperber 1996 for a general view of culture along the lines of an “epidemiology of representations”). A significant feature of totemism that enhances both memorability and its capacity to grab attention is that it violates the general behavior of biological species: members of a totem, unlike members of a generic species, generally do not interbreed, but only mate with members of other totems to create a system of social exchange. Notice that this violation of core knowledge is far from arbitrary. In fact, it is such a pointed violation of human beings' intuitive ontology that it readily mobilizes most of the assumptions people ordinarily make about biology to better help build societies around the world (Atran & Sperber 1991).

In the structuring of such metarepresentations, then, the net result appears close to an optimal balance between memorability, attention-grabbing power, and flexibility in assimilating and adapting to new and relevant information. This is to assure both ease of transmissibility and long-standing cultural survival. More generally, incorporating recurrently emerging themes in religious and symbolic

thought into cognitive science can be pursued as a research program, which focuses on the transmission metarepresentational elaborations of intuitive ontologies or core memes (see Boyer 1994a for such a general framework for the study of religion).

This distinction between convergent and descendant metacognitive memes is not absolute. Creationism, for example, has both cross-culturally recurrent themes of supernatural species reification and particular perspectives on the nature of species that involve outworn scientific theories, as well as specific historical traditions. Here as well, knowledge of the universal core of such beliefs helps to identify what is, and what is not, beyond the range of ordinary common sense (Atran 1990). Finally, even aspects of the metarepresentational knowledge that science produces as output can feed back (as input) in subtle and varied ways into the core module's actual domain: for example, learning that whales are not fish and that bats are not birds. But the feedback process is also constrained by the intuitive bounds of domain-specific common sense (Atran 1987b).

The message here is that evolutionary psychology might profit from a source barely tapped: the study of cultural transmission. Some bodies of knowledge have a life of their own, only marginally affected by social change (e.g., intuitive mechanics, basic color classification, folk-biological taxonomies); others depend for their transmission, and hence for their existence, on specific institutions (e.g., totemism, creationism, evolutionary biology).<sup>9</sup> This suggests that culture is not an integrated whole, relying for its transmission on undifferentiated cognitive abilities. But the message is also one of “charity” concerning the mutual understanding of cultures (Davidson 1984a): anthropology is possible because underlying the variety of cultures are diverse but universal commonalities. This message also applies to the disunity and comprehensibility of science (sect. 3).

## 2. Cultural elaborations of universal taxonomy

Despite the evident primacy of ranked taxonomies in the elaboration of folk-biological knowledge in general, and the cognitive preference for generic species in particular, I no longer think that folk taxonomy defines the inferential character of folk biology as strongly as I indicated in a previous work, *Cognitive foundations of natural history* (Atran 1990). Mounting empirical evidence gathered with colleagues suggests that although universal taxonomic structures universally constrain and guide inferences about the biological world, different cultures (and to a lesser extent different individuals within a culture) show flexibility in which inferential pathways they choose (for details see Atran 1995a; in press; Coley et al., in press; López et al. 1997; Medin et al. 1996; 1997). Different tendencies apparently relate to different cultural criteria of relevance for understanding novelties and uncertainties in the biological world and in adapting to them.

For example, among the Itzaj Maya, in contrast to the systematic use of taxonomies by scientists or modern (non-aboriginal) American folk, understanding ecological relationships seems to play a role on a par with morphological and underlying biological relationships in determining how taxa may be causally interrelated. For centuries, Itzaj have managed to so use their folk-biological structures to organize and maintain a fairly stable, context-sensitive, biologi-

cal and ecological order. In a different way, scientists use taxonomies as heuristics for reaching a more global, ecologically context-free understanding of biological relationships underlying the diversity of life. American folk unwittingly pursue a compromise of sorts: maintaining ecologically valid folk categories, but reasoning about them as if they were theory based. Irrelevancy often results.

### 2.1. Taxonomy-based inference across cultures

To illustrate, consider some recent experimental findings. Our intention was to see whether and how Americans and Maya reason the same or differently from their respective taxonomies to determine the likely distribution of unfamiliar biologically related properties. Our strategy was as follows: first we asked individual informants to perform successive sorting tasks of name cards or colored picture cards (or specimens in Itzaj pilot studies) to elicit individual taxonomies. Then we used statistical measures to see whether or not the data justified aggregating the individual taxonomies for each informant group into a single “cultural model” that could confidently retrodict most (of the variance in) informant responses. Finally, we used the aggregated cultural taxonomies to perform various category-based inference tasks with the same or different informants. At each stage of the sorting and inference tasks we asked informants to justify responses. In sum, our techniques enabled us to describe an aggregate model of taxonomy for each population to determine emergent patterns of cultural preferences in matters of biological inference.

#### 2.1.1. An experimental method for generating taxonomies.

In the sorting tasks, each set of cards represented either all the generic species of a life form (Itzaj and Michigan mammals) or intermediate category (Itzaj palms), or a large range of the generic species of a life form (e.g., all local trees in the Evanston-Chicago area for people living in the area). The aim was to obtain individual taxonomies that covered the range of relationships between intermediate folk taxa, that is, taxonomic relationships *between* the generic-species and life-form levels. This was motivated by the fact that the boundaries of intermediate taxa vary somewhat more across individuals and cultures than do ranked taxa, and our goal was to explore the differences as much as the similarities in taxonomy-based reasoning across cultures. Furthermore, the intermediate level of taxonomy is where evolutionary relationships are most visibly manifest and comprehensible (both in the history of science and among educated lay folk, see Atran 1983), and where ecological relationships are most manifest for Maya (e.g., in the habits of arboreal mammals on the fruiting and reproduction of canopy trees). We thought these factors would increase the possibility of ascertaining whether significant differences between Americans and Maya relate to different goals for understanding biological relationships: one weighted by the influence of science in American culture, and the other weighted by interests of subsistence and survival in the Maya rainforest.

**2.1.1.1. Methods.** What follows is a brief account of findings in regard to all mammals represented in the local environments of the Itzaj and Michigan groups, respectively.<sup>10</sup> For Itzaj we included bats, although Itzaj do not consider them mammals. For the students we included the emblematic wolverine, although it has practically disap-

peared from Michigan. We asked American informants to sort name cards of all local mammal generic species into successive piles according to the degree they “go together by nature.” For Itzaj, name cards were Mayan words in Latin letters and informants were asked to successively sort cards according to the degree to which they “go together as companions” (*uy-et' -ok*) of the same “natural lineage” (*uch'ib'al*). When informants indicated no further desire to successively group cards, the first piles were restored and the informants were asked to subdivide the piles until they no longer wished to do so. The “taxonomic distance” between any two taxa (cards) was then calculated according to where in the sorting sequence they were first grouped together. Although a majority of Itzaj informants were functionally illiterate, they had no trouble manipulating name cards as mnemonic icons. No differences were observed in handling cards between literate and illiterate Itzaj, and no statistically significant differences in results. We chose name cards over pictures or drawings to minimize stimulus effects and maximize the role of categorical knowledge.

#### 2.1.1.2. Results: Convergence and divergence in intermediate-level classifications.

Results indicate that the individual mammal taxonomies of Itzaj and students from rural Michigan are all more or less competent expressions of comparably robust cultural models of the biological world.<sup>11</sup> To compare the structure and content of cultural models with one another, and with scientific models, we mathematically compared the topological relations in the tree structure of each group’s aggregate taxonomy with those of a classic evolutionary taxonomy, that is, one based on a combination of morphological and phylogenetic considerations.<sup>12</sup>

There was substantial shared agreement between the aggregated taxonomies of Itzaj (Fig. 3) and Michigan students (Fig. 4), between evolutionary taxonomy (Fig. 5) and Itzaj taxonomy, and between evolutionary taxonomy and the American folk taxonomy. Agreement between the intermediate folk taxonomies and evolutionary taxonomy is maximized at around the level of the scientific family, both for Itzaj and Michigan subjects, indicating an intermediate-level focus in the folk taxonomies of both cultures. On the whole, taxa formed at this level are still imageable (e.g., the cat or dog families).

A closer comparison of the folk groupings in the two cultures, however, suggests that there are at least some cognitive factors at work in folk-biological classification that are mitigated or ignored by science. For example, certain groupings, such as felines + canines, are common to both Itzaj and Michigan students, although felines and canines are phylogenetically further from one another than either family is to other carnivore families (e.g., mustelids, procyonids, etc.). These groupings of large predators indicate that size and ferocity or remoteness from humans is a salient classificatory dimension in both cultures (cf. Henley 1969; Rips et al. 1973). These are dimensions that a corresponding evolutionary classification of the local fauna does not highlight.

An additional nonscientific dimension in Itzaj classification, which is not present in American classification, relates to ecology. For example, Itzaj form a group of arboreal animals, including monkeys as well as tree-dwelling procyonids (kinkajou, cacomistle, raccoon) and squirrels (a rodent). The ecological nature of this group was in-

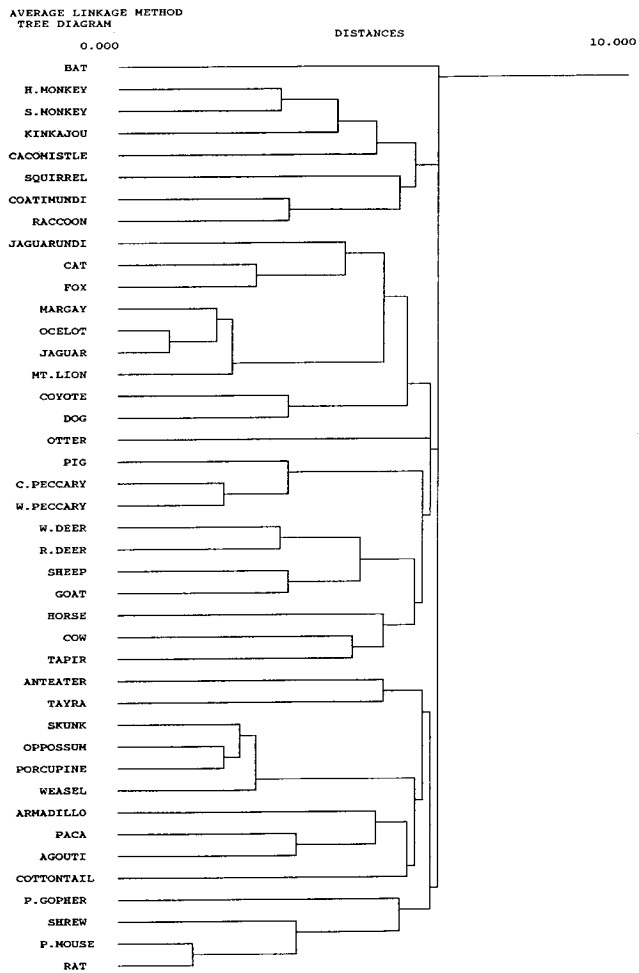

Figure 3. Folk taxonomy of Mayaland mammals. Average link cluster analysis of the aggregated sortings of mammals by Itzaj Maya ( $n = 12$ ).

independently confirmed as follows: we asked informants to tell us which plants are most important for the forest to live. Then, we aggregated the answers into a cultural model, and for each plant in the aggregate list we asked which animals most interacted with it (without ever asking directly which animals interact with one another). The same group of arboreal animals emerged as a stable cluster in interactions with plants (Altran et al., under review).

Other factors in the divergence between folk and scientific taxonomies are related both to science's global perspective in classifying local biota and to its reliance on biologically "deep," theoretically weighted properties of internal anatomy and physiology. Thus, the opossum is the only marsupial in North and Central America. Both Itzaj and Midwesterners relate the opossum to skunks and porcupines because it shares with them readily perceptible features of morphology and behavior. From a scientific vantage, however, the opossum is taxonomically isolated from all the other locally represented mammals in a subclass of its own. One factor mitigating the ability of Itzaj or Midwesterners to appreciate the opossum as scientists do is the absence of other locally present marsupials to which to relate the opossum. As a result, both Michigan students and Itzaj are apparently unaware of the deeper biological significance of the opossum's lack of a placenta.

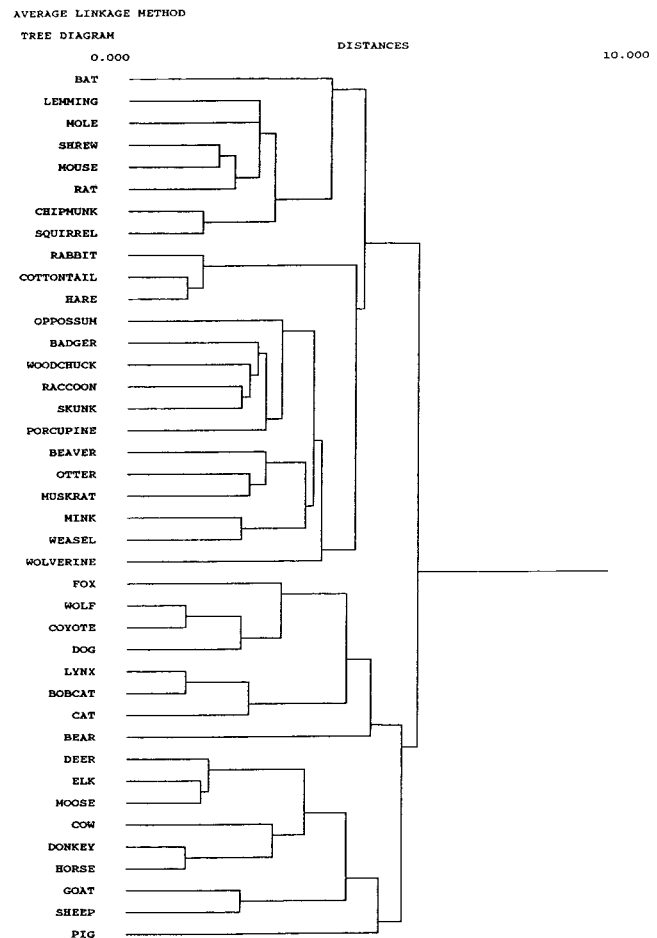

Figure 4. Folk taxonomy of Michigan mammals. Average link cluster analysis of the aggregated sortings of mammals by Michigan students ( $n = 12$ ).

**2.1.2. Taxonomy-driven inductions.** Our inference studies were designed to explore further how the underlying reasons for these these apparent similarities and differences in intermediate-level taxonomies might inform category-based inductions among Maya, lay Americans, and scientists. We tested for three category-based induction phenomena: taxonomic similarity, taxonomic typicality, and taxonomic diversity (cf. Osherson et al. 1990).

**2.1.2.1. Taxonomic similarity.** Similarity involves judging whether inference from a given premise category to a conclusion category is stronger than inference from some other premise to the same conclusion, where the premise and conclusion categories are those in the aggregate taxonomic tree. Similarity predicts that the stronger inference should be the one in which the premise is closest to the conclusion, with "closeness" measured as the number of nodes in the tree one has to go through to reach the conclusion category from the premise category. So, suppose that sheep have some unfamiliar property (e.g., "ulnar arteries") or are susceptible to an unknown disease ("eta"). Suppose, as an alternative premise, that cows have a different property ("sesamoid bones") or are susceptible to a different disease (e.g., "ina"). Following any of the three taxonomies (Maya, American, or evolutionary), one should conclude that it is

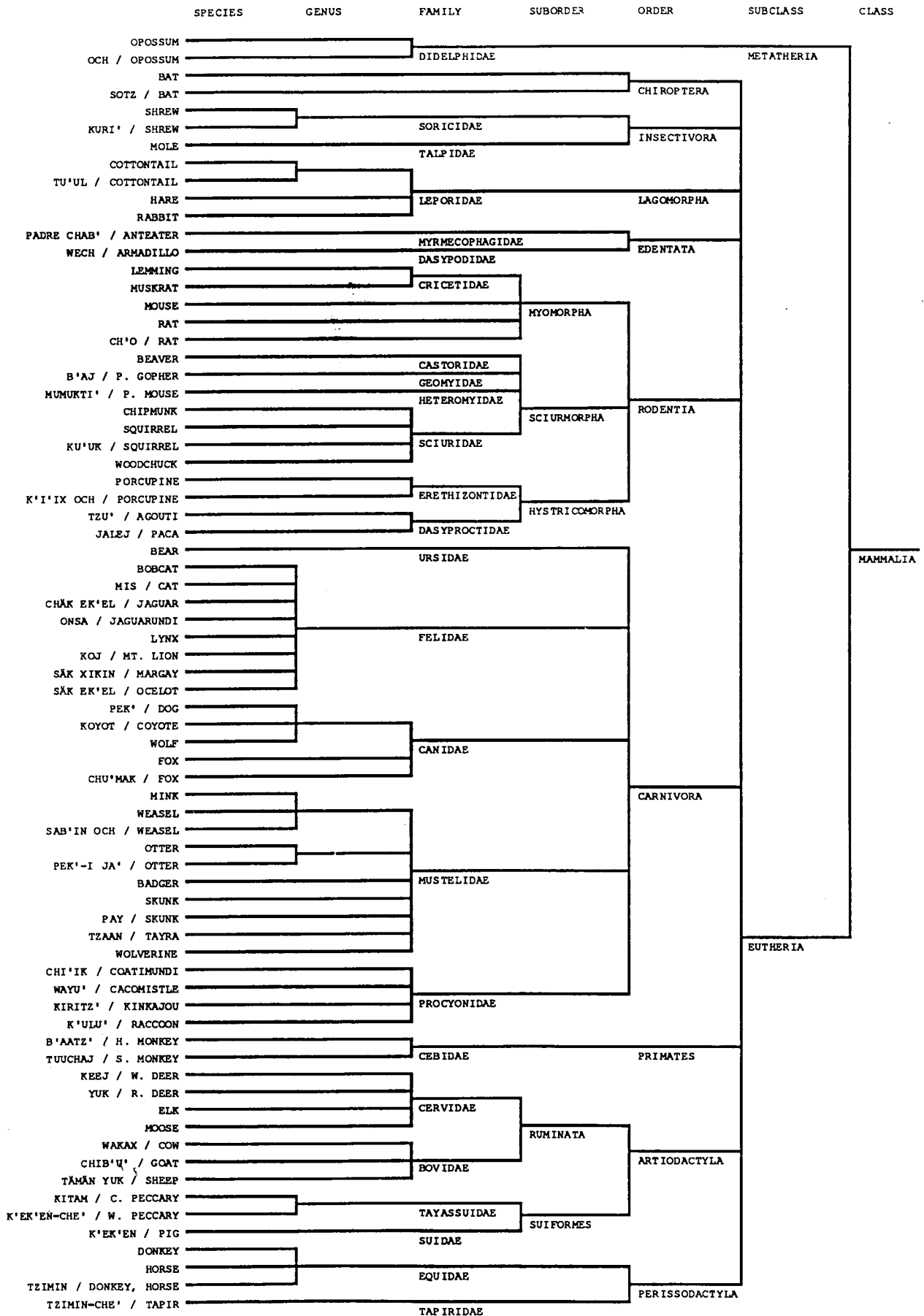

Figure 5. Scientific taxonomy of mammals in Mayaland and Michigan. Evolutionary classification of all mammal species used in studies with Itzaj Maya and Michigan students.

more likely that goats have what sheep have than what cows have, because goats are taxonomically closer to sheep than they are to cows.

If similarity is a built-in feature of folk taxonomy, then American and Maya inductions should converge and diverge where their taxonomies do. They should also resemble and depart from scientific inductions where their taxonomies do regarding the scientific taxonomy. In fact, both Americans and Maya chose items like *sheep/goat* versus *cow/goat*. This confirms the convergence of the scientific taxonomy with reasoning among both Americans and Maya precisely where the structure of their respective taxonomies should lead us to expect convergence.

Both also chose items like *opossum/porcupine* versus *squirrel/porcupine*, which confirms the expected convergence between Maya and American classifications, and also the expected divergence of both groups from scientific classification. Choice of items such as *dog/fox* for Americans but *cat/fox* for Maya confirms that Americans reason more in line with scientific classifications in such cases than do Maya. In fact, justifications show that Itzaj recognize numerous similarities between foxes and dogs (snout, paw, manner of copulation), but judge that foxes are closer to cats because of interrelated aspects of size and predatory habits.

**2.1.2.2. Taxonomic typicality.** The metric for typicality, like the one for similarity, is given by the taxonomy itself, as the lowest average taxonomic distance. In other words, the typicality of an item (e.g., a generic species) is the average taxonomic distance of that item from all other items in the inclusive category (e.g., life form). Items that are more typical provide greater coverage of the category than items that are less typical. For example, Itzaj choose the items *jaguar/mammal* or *mountain lion/mammal* over *squirrel/mammal* or *raccoon/mammal*, judging that all mammals are more likely to be susceptible to a disease that jaguars or mountain lions have than to a disease that squirrels or raccoons have.

This is because Maya consider jaguars and mountain lions more typical of mammals than squirrels or raccoons. In fact, jaguars and mountain lions are not merely typical for Itzaj because they are more directly related to other mammals than squirrels or raccoons; they also more closely represent an ideal standard of the “true animal/mammal” (*jach b'a'al-che'*) against which the appearance and behavior of all other animals may be judged. This is evident from Itzaj justifications, as well as from direct ratings of which mammals the Itzaj consider to be the “truest.”

By contrast, American informants choose the items *squirrel/mammal* or *raccoon/mammal* over *bobcat/mammal* or *lynx/mammal*, presumably because they consider squirrels and raccoons more typical of mammals for Americans than bobcats or lynxes. Note that typicality in these cases cannot be attributed to frequency of occurrence or encounter. Our American subjects on this task were all raised in rural Michigan, where the frequency of encounter with squirrels, raccoons, bobcats, and lynxes is nowadays about as likely as the corresponding Itzaj encounter with squirrels, raccoons, jaguars, and mountain lions. Both the Americans and Maya were also more or less familiar with all animals in their respective tasks.

In each case for which we have Itzaj typicality ratings, the “truest” and most taxonomically typical taxa are large, perceptually striking, culturally important, and ecologically

prominent. The dimensions of perceptual, ecological, and cultural salience all appear necessary to a determination of typicality, but none alone appears to be sufficient. For example, jaguars are beautiful and big (but cows are bigger), their predatory home range (about 50 km<sup>2</sup>) determines the extent of a forest section (but why just this animal's home range?), and they are “lords” of the forest (to which even the spirits pay heed). In other words, typicality for the Itzaj appears to be an integral part of the human (culturally relevant) ecology. Thus, the Itzaj say that wherever the sound of the jaguar is not heard, there is no longer any “true” forest, nor any “true” Maya. Nothing of this sort appears to be the case with American judgments of biological typicality and typicality-based biological inference. Thus, the wolverine is emblematic in Michigan, but carries no preferential inductive load.

**2.1.2.3. Taxonomic diversity.** Like taxonomically defined typicality, diversity is a measure of category coverage. But a pair of typical items provides less coverage than, say, a pair containing one item that is typical and another that is atypical. For example, given that horses and donkeys share some property, but that horses and gophers share some other property, our American subjects judge that all mammals are more likely to have the property that horses share with gophers than the property that horses share with donkeys. This is because the average taxonomic distance of donkeys to other mammals is about the same as that of horses, so that donkeys add little information that could not be inferred from horses alone. For example, the distance from horses and donkeys to cows is uniformly low, whereas the distance to mice is uniformly high. Now, the distance from horses to cows is low, but so is the distance from gophers to mice. Thus, information about both horses and gophers is likely to be more directly informative about more mammals than information about only horses and donkeys.

Whereas both Americans and Itzaj consistently show similarity and typicality in taxonomy-based reasoning, the Itzaj do not show diversity. However, Itzaj noncompliance with diversity-based reasoning apparently results neither from a failure to understand the principle of diversity nor from any problems of “computational load,” such as those that seem to affect the inability of young school children to reason in accordance with diversity (López et al. 1992). As with the most evident divergences between American and Itzaj performance on similarity and typicality tasks, divergence on diversity apparently results from ecological concerns.

The diversity principle broadly corresponds to the fundamental principle of induction in systematics: a property shared by two organisms (or taxa) is likely shared by all organisms falling under the smallest taxon containing the two (Warburton 1967). Thus, American folk seem to use their biological taxonomies much as scientists do when given unfamiliar information to infer what is likely in the face of uncertainty: informed that goats and mice share a hitherto unknown property, they are more likely to project that property to mammals than if informed that goats and sheep do. By contrast, Itzaj tend to use similarly structured taxonomies to search for causal ecological explanations of why unlikely events should occur: for example, bats may have passed on the property to goats and mice by biting them, but a property does not need an ecological agent to be shared by goats and sheep.

In the absence of a theory – or at least the presumption

of a theory – of causal unity underlying disparate species, there is no compelling reason to consider a property discovered in two distant species as biologically intrinsic or essential to both. It may make as much or more sense to consider the counterintuitive presence of a property in dissimilar species as the likely result of an extrinsic or ecologically “accidental” cause. Notice that in both the American and Itzaj cases similarly structured taxonomies provide distance metrics over which biological induction can take place. For the Americans, taxonomic distance generally indicates the extent to which underlying causes are more likely than surface relationships to predict shared biological properties. For Itzaj, taxonomic distance offers one indication of the extent to which ecological agents are likely to be involved in predicting biological properties that do not conform to surface relationships.

A priori, either stance might be correct. For example, diseases are clearly biologically related; however, distribution of a hitherto unknown disease among a given animal population could well involve epidemiological factors that depend on both inherent biological susceptibility and ecological agency. Equally “appropriate” ecological strategies may be used to reason about unfamiliar features of anatomy, physiology, and behavior (e.g., in regard to predators or grazers), and even reproduction and growth (e.g., possible animal hybridizations or plant graftings).<sup>13</sup>

This does not mean that Itzaj do not understand a diversity principle. In their justifications, Itzaj clearly reject a context-free use of the diversity principle in favor of context-sensitive reasoning about likely causal connections. In fact, in a series of tasks designed to assess risk-diversification strategies (e.g., sampling productivity from one forest plot or several) Itzaj consistently showed an appreciation of the diversity principle in these other settings. This suggests that although diversity may be a universal reasoning heuristic, it is not a universal aspect of folk-biological taxonomy.

More generally, what “counts” as a biological cause or property may differ somewhat for folk, like the Itzaj, who necessarily live in intimate awareness of their surroundings, and those, like American folk, whose awareness is less intimate and necessary. For Itzaj, awareness of biological causes and properties may directly relate to ecology, whereas for most American folk the ecological ramifications of biological causes and properties may remain obscure. Historically, the West’s development of a worldwide scientific systematics explicitly involved disregard of ecological relationships, and of the colors, smells, sounds, tastes, and textures that constitute the most intimate channels of Maya recognition and access to the surrounding living world. For example, the smell of animal excrement so crucial to Maya hunters, or the texture of bark so important to their recognition of trees in the dark forest understory, simply have no place in a generalized and decontextualized scientific classification.

**2.1.2.4. Science’s marginal role for American folk.** A good candidate for the cultural influence of theory in American folk biology is science. Yet, the exposure of Michigan students to science education has little apparent effect on their folk taxonomy. From a scientific view, student taxonomies are no more accurate than those of Itzaj. Science’s influence is at best marginal. For example, science may peripherally bear on the differences in the way Itzaj and Michigan students categorize bats. Itzaj deem bats to be birds (*ch’üch’*), not mammals (*b’a’al-che’*).

Like Midwesterners, Itzaj acknowledge in interviews that there is a resemblance between bats and small rodents. Because Itzaj classify bats with birds, they consider the resemblance to be only superficial and not indicative of a taxonomic relationship. By contrast, Michigan students “know” from schooling that bats are mammals. But this knowledge can hardly be taken as evidence for the influence of scientific *theory* on folk taxonomy. Despite learning that bats are mammals, the students go on to relate bats to rats just as Itzaj might if they did not already “know” that bats are birds. Nevertheless, from an evolutionary standpoint bats are taxonomically no closer to rats than to cats. The students, it seems, pay scant attention to the deeper biological relationships science reveals. In other words, the primary influence of science education on folk-biological knowledge may be to fix category labels, which in turn may affect patterns of attention and induction.

The influence of science education on folk induction may also reflect less actual knowledge of theory than willing belief that scientific theory supports folk taxonomy. For example, given that skunk and opossum share a deep biological property, Michigan students are less likely to conclude that all mammals share the property than if it were shared by a skunk and a coyote. From a scientific standpoint, the students employ the right reasoning strategy (diversity-based inference), but reach the wrong conclusion because of a faulty taxonomy (i.e., the belief that skunks are taxonomically further from coyotes than from opossums). Yet if told that opossums are phylogenetically more distant from skunks than coyotes are, the students readily revise their taxonomy to make the correct inference. Still, it would be misleading to claim that the students then use theory to revise their taxonomy, although a revision occurs in accordance with scientific theory.

**2.1.3. A failing compromise.** With their ranked taxonomic structures and essentialist understanding of species, it would seem that no great cognitive effort is additionally required for the Itzaj to recursively essentialize the higher ranks as well, and thereby avail themselves of the full inductive power that ranked taxonomies provide. But contrary to earlier assumptions (Atran 1990), our studies show this is not the case. Itzaj, and probably other traditional folk, do not essentialize ranks: they do not establish causal laws at the intermediate or life-form levels, and do not presume that higher-order taxa share the kind of unseen causal unity that their constituent generic species do.

There seems to be, then, a sense of Itzaj “failure” in turning their folk taxonomies into one of the most powerful inductive tools that humans may come to possess. To adopt this tool, Itzaj would have to suspend their primary concern with ecological and morphobehavioral relationships in favor of deeper, hidden properties of greater inductive potential. But the cognitive cost would probably outweigh the benefit (Sperber & Wilson 1986). For this potential, which science strives to realize, is to a significant extent irrelevant, or only indirectly relevant, to local ecological concerns.

Scientists use diversity-based reasoning to generate hypotheses about global distributions of biological properties so that theory-driven predictions can be tested against experience and the taxonomic order subsequently restructured when prediction fails. By contrast, American folk do not have the biological theories to support diversity-based



reasoning that scientists do. If they did, American folk would not have the categories they do.

## 2.2. The general-purpose nature of folk taxonomy

These experimental results in two very different cultures – an industrialized Western society and a small-scale tropical forest society – indicate that people across cultures organize their local flora and fauna in similarly structured taxonomies. Yet they may reason from their taxonomies in systematically different ways. These findings, however, do not uphold the customary distinction in anthropology and in history and the philosophy of biology, between “general-purpose” scientific classifications that are designed to maximize inductive potential and “special-purpose” folk-biological classifications (Bulmer 1970; Gilmour & Walters 1964), which are driven chiefly by “functional” (Dupré 1981), “utilitarian” (Hunn 1982), or “social” (Ellen 1993) concerns. On the contrary, like scientific classifications, folk-biological taxonomies appear to be “general-purpose” systems that maximize inductive potential for infinitely many inferences and ends. That potential, however, may be conceived differently by a small-scale society and a scientifically oriented community.

For scientific systematics, the goal is to maximize inductive potential regardless of human interest. The motivating idea is to understand nature as it is “in itself,” independently of the human observer (as far as possible). For the Itzaj, and arguably for other small-scale societies, folk-biological taxonomy works to maximize inductive potential relative to human interests. Here, folk-biological taxonomy provides a well-structured but adaptable framework. It allows people to explore the causal relevance to them – including the ecological relevance – of the natural world, and in indefinitely many and hitherto unforeseen ways. Maximizing the human relevance of the local biological world – its categories and generalizable properties (including those yet to be discovered) – does not mean assigning predefined purposes or functional signatures to it. Instead, it implies providing a sound conceptual infrastructure for the widest range of human adaptation to surrounding environmental conditions, within the limits of culturally acceptable behavior and understanding.

For scientific systematics, folk biology may represent a ladder to be discarded after it has been climbed, or at least set aside while scientists surf the cosmos. But those who lack traditional folk knowledge, or implicit appreciation of it, may be left in the crack between science and common sense. For an increasingly urbanized and formally educated people, who are often unwittingly ruinous of the environment, no amount of cosmically valid scientific reasoning skill may be able to compensate for the local loss of ecological awareness on which human survival may ultimately depend.

## 3. Science and common sense in systematic biology

The scenario that I have explored so far comes to this: some areas of culture in general, as well as particular scientific fields, are based in specific cognitive domains that are universal to human understanding of nature. Concern with elaborating this basis produces recurrent themes across cultures (e.g., totemism), and its evaluation constitutes

much of the initial phases in the development of a science (e.g., natural history). The next sections take a closer look at later phases in the development of systematic biology, where knowledge of the world comes to transcend the bounds of sense without, however, completely losing sight.

The experimental evidence reviewed in the previous sections suggests that people in small-scale, traditional societies do not spontaneously extend assumptions of an underlying essential nature to taxa at ranks higher than the generic species. Thus, to infer that a biological property found in a pair of organisms belonging to two very different looking species (e.g., a chicken and an eagle) likely belongs to all organisms in the lowest taxon containing the pair (e.g., *bird*) may require a reflective elaboration of causal principles that are not related to behavior, morphology, or ecological proclivity in any immediately obvious way. Only this would justify the assumption that all organisms belonging to a taxon at a given rank share equally some internal structure regardless of apparent differences between them.

Such predictions lead to errors as well as discoveries. This sets into motion a “boot-strapping” reorganization of taxa and taxonomic structure, and of the inductions that the taxonomy supports. For example, upon discovery that bats bear and nurture their young more like mammals than birds, it is then reasonable to exclude bats from *bird* and include them with *mammal*. Despite the “boot-strapping” revision of taxonomy implied here, notice how much did not change: neither the overall structure of folk taxonomy, nor – in a crucial sense – even the kinds involved. Bats, birds, whales, mammals, and fish did not just vanish from common sense to arise anew in science. There was a redistribution of affiliations between antecedently perceived kinds. What had altered was the construal of the underlying natures of those kinds, with a redistribution of kinds and a reappraisal of properties pertinent to reference.

Historically, taxonomy is conservative, but it can be revolutionized. Even venerable life forms, like *tree*, are no longer scientifically valid concepts because they have no genealogical unity (e.g., legumes are variously trees, vines, bushes, etc.). The same may be true of many longstanding taxa. Phylogenetic theorists question the “reality” of zoological life forms, such as *bird* and *reptile*, and the whole taxonomic framework that made biology conceivable in the first place. Thus, if birds descended from dinosaurs, and if crocodiles – but not turtles – are also directly related to dinosaurs, then: crocodiles and birds form a group that excludes turtles, or crocodiles, birds, and turtles form separate groups, or all form one group. In any event, the traditional separation of *bird* and *reptile* is no longer tenable.

Still, even in the midst of their own radical restructuring of taxonomy, Linnaeus and Darwin would continue to rely on popular life forms like *tree* and *bird* to collect and understand local species arrangements, as botanists and zoologists do today. As for ordinary people, and especially those who live intimately with nature, they can ignore such ecologically salient kinds only at their peril. That is why science cannot simply subvert common sense.

### 3.1. Aristotelian essentials

The boot-strapping enterprise in Western science began with Aristotle, or at least with the naturalistic tradition from ancient Greece he represented. His task was to unite the various foundational forms of the world – each with its own

special underlying nature” (*phusis* in the implicit everyday sense) – into an overarching system of “Nature” (*phusis* in an explicitly novel, metaphysical sense). In practice, this meant systematically deriving each generic species (*atomon eidos*) from the causal principles uniting it to other species of its life form (*megiston genos*). It also implied combining the various life forms by “analogy” (*analogian*) into an integrated conception of life. Theophrastus, Aristotle’s disciple, conceived of botanical classification in a similar way.

Aristotelian life forms are distinguished and related through possession of analogous organs of the same essential function (locomotion, digestion, reproduction, respiration). For example, bird wings, quadruped feet, and fish fins are analogous organs of locomotion. The generic species of each life form are then differentiated by degrees of “more or less” with respect to essential organs. Thus, all birds have wings for moving about and beaks for obtaining nutriment. But, whereas the predatory eagle is partially diagnosed by long and narrow wings and a sharply hooked beak, the goose – owing to its different mode of life – is partially diagnosed by a lesser and broader wing span and flatter bill. A principled classification of biological taxa by “division and assembly” (*diarexis* and *synagoge*) ends when all taxa are defined, with each species completely diagnosed with respect to every essential organ (Atran 1985b).

In the attempt to causally link up all taxa, and derive them from one another, Aristotle took the first step in decontextualizing nature from its ecological setting. For him, birds were not primarily creatures that live in trees and the air, but causal complexes of life’s essential organs and functions from which generic species derive. Life forms become causal way stations in the essential processes that link the animal and plant kingdoms to generic species. As a result, all higher ranks are now essentialized on a par with generic species, and the principle of taxonomic diversity becomes the basis for causal inference in systematics: any biological property that can be presumed to be related to life’s essential organs and functions, if shared by two generic species, can be expected to be shared in descending degrees by all organisms in the life form containing the two.

This first sustained scientific research program failed because it was still primarily a local effort geared to explaining a familiar order of things. Aristotle knew of species not present in his own familiar environment, but he had no idea that there were orders of magnitude of difference between what was locally apparent and what existed worldwide. Given the (wrong) assumption that a phenomenal survey of naturally occurring kinds was practically complete, he hoped to find a true and consistent system of essential characters by trial and error. He did not foresee that introduction of exotic forms would undermine his quest for a discovery of the essential structure of all possible kinds. But by inquiring into how the apparently diverse natures of species may be causally related to the nature of life, Aristotle established the theoretical program of natural history (as biology was called before evolutionary theory).

### 3.2. The Linnaean hierarchy

As in any folk inventory, ancient Greeks and Renaissance herbalists contended with only 500 or 600 local species (Raven et al. 1971). Preferred taxa often correspond to scientific species (dog, coyote, lemon tree, orange tree), but frequently a scientific genus has only one locally occurring

species (bear, redwood), which makes species and genus perceptually coextensive. This occurs regularly with the most phenomenally salient organisms, including mammals and trees (e.g., in a comparative study, we found that 69% of tree genera in both the Chicago area – 40 of 58 – and the Itzaj area of the Peten rainforest – 158 of 229 – are monospecific, see Medin et al. 1997).

Europe’s “Age of Exploration,” which began during the Renaissance, presented the explorers with a dazzling array of new species. The emerging scientific paradigm required that these new forms be ordered and classified within a global framework that unaided common sense could no longer provide. This required a further decontextualizing of nature, which the newly developed arts of block printing and engraving allowed. In what is widely regarded as the first “true-to-nature” herbal of the Renaissance (Brunfels 1530–1536), a keen historian of science notes: “The plant was taken out of the water, and the roots were cleansed. What therefore we see depicted is a water lily without water – isn’t this a bit paradoxical? All relations between the plant and its habitat have been broken and concealed” (Jacobs 1980, p. 162). By isolating organisms from local habitats through the sense-neutral tones of written discourse, a global system of biological comparisons and contrasts could develop. This meant sacrificing local “virtues” of folk-biological knowledge, including cultural, ecological, and sensory information.

In the Post-Renaissance, decontextualization of preferred folk taxa eventually led to their “fissioning” into species (Cesalpino 1583) and genera (Tournefort 1694). During the initial stages of Europe’s global commercial expansion, the number of species increased by an order of magnitude. Foreign species were habitually joined to the most similar European species, that is, to the generic type, in a “natural system.” Enlightenment naturalists, like Jungius and Linnaeus, further separated natural history from its cognitive moorings in human ecology, banning from botany intuitively “natural” but scientifically “lubricious” life forms, such as *tree* and *grass* (Linnaeus 1751, sect. 209).

A similar “fissioning” of intermediate folk groupings occurred when the number of encountered species increased by another order of magnitude, and a “natural method” for organizing plants and animals into families (Adanson 1763) and orders (Lamarck 1809) emerged as the basis of modern systematics. Looking to other environments to complete local gaps at the intermediate level, naturalists sought to discern a worldwide series that would cover all environments and again reduce the ever-increasing number of discovered species to a mnemonically manageable set – this time to a set of basic, family plans. Higher-order vertebrate life forms were left to provide the initial framework for biological classes, which only phylogenetic theory would call into question.

A concept of phylum became distinguished once it was realized that there is less internal differentiation between all the vertebrate life forms taken as a whole than there is within most intermediate groupings of the phenomenally “residual” life form, *insect* (bugs, worms, etc.). This was because of Cuvier (1829), who first reduced vertebrates to a single “branch” (*embranchment*). Finally, climbing the modified ranks of folk biology to survey the diversity of life, Darwin was able to show how the whole ordering of species could be transformed into the tree of life – a single emerg-

ing Nature governed by the causal principles of natural selection.

### 3.3. Folk biology's enduring embrace

From Linnaeus's time to the present day, biological systematics has used explicit principles and organizing criteria that traditional folk might consider secondary or might not consider at all (e.g., the geometrical composition of a plant's flower and fruit structure, or the numerical breakdown of an animal's blood chemistry). Nevertheless, as with Linnaeus, the modern systematist initially depends implicitly, and crucially, on a traditional folk appreciation. As Bartlett noted with specific reference to the Maya region of Peten:

A botanist working in a new tropical area is . . . confronted with a multitude of species which are not only new to him, but which flower and fruit only at some other season than that of his visit, or perhaps so sporadically that he can hardly hope to find them fertile. Furthermore, just such plants are likely to be character plants of [ecological] associations. . . . [C]onfronted with such a situation, the botanist will find that his difficulties vanish as if by magic if he undertakes to learn the flora as the natives know it, using their plant names, their criteria for identification (which frequently neglect the fruiting parts entirely), and their terms for habitats and types of land. (Bartlett 1936, p. 5; cf. Diamond 1966 for zoology)

As Linnaeus needed the life form *tree* and its common species to actually do his work, so did Darwin need the life form *bird* and its common species. From a strictly cosmic viewpoint, the title of his great work *On the origins of species* is ironic and misleading – much as if Copernicus had entitled his attack on the geocentric universe, *On the origins of sunrise*. Of course, to attain that cosmic understanding, Darwin could no more dispense with thinking about “common species” than Copernicus could avoid thinking about the sunrise (Wallace 1901, pp. 1–2). In fact, not just species, but all levels of universal folk taxonomy served as indispensable landmarks for Darwin's awareness of the evolving pathways of diversity: from the folk-specifics and varietals whose variation humans had learned to manipulate, to intermediate-level families and life-form classes, such as bird, within which the godlier processes of natural selection might be discerned:

There are twenty-six land birds [in the Galápagos Islands]; of these twenty-one or perhaps twenty-three are ranked a distinct species, and would commonly be assumed to have been here created; yet the close [family] affinity of most of these birds to American species is manifest in every character, in their habits, gestures, and tones of voice. So it is with other animals, and with a large proportion of plants. . . . Facts such as these, admit of no sort of explanation on the ordinary view of creation. (Darwin 1872/1883, pp. 353–354)

Use of taxonomic hierarchies in systematics today reveals a similar point. By tabulating the ranges of extant and extinct genera, families, classes, and so on, systematists can provide a usable compendium of changing diversity throughout the history of life. For example, by looking at just numbers of families, it is possible to ascertain that insects form a more diverse group than tetrapods (i.e., terrestrial vertebrates, including amphibians, birds, mammals, and reptiles). By calculating whether or not the taxonomic diversity in one group varies over time as a function of the taxonomic diversity in another group, evidence can be garnered for or

against the evolutionary interdependence of the two groups. Recent comparisons of the relative numbers of families of insects and flowering plants reveal the surprising fact that insects were just as taxonomically diverse before the emergence of flowering plants as after. Consequently, evolutionary effects of plant evolution on the adaptive radiation of insects are probably less profound than previously thought (Labandeira & Sepkoski 1993). The heuristic value of (scientifically elaborated) folk-based strategies for cosmic inquiry is compelling, despite evolutionary theorists being well aware that no “true” distinctions exist between various taxonomic levels.

Not only do taxonomic structure and species continue to agitate science – for better or worse – but also the nonintentional and nonmechanical causal processes that people across the world assume to underlie the biological world. Vitalism is the folk belief that biological kinds – and their maintaining parts, properties, and processes – are teleological, and hence not reducible to the contingent relations that govern inert matter. Its cultural expression varies (cf. Hatano & Inagaki 1994). Within any given culture people may have varying interpretations and degrees of attachment to this belief: some who are religiously inclined may think that a “spiritual” essence determines biological causality; others of a more scientific temperament might hold that systems of laws that suffice for physics and chemistry do not necessarily suffice for biology. Many, if not most, working biologists (including cognitive scientists) implicitly retain at least a minimal commitment to vitalism: they acknowledge that physiochemical laws should suffice for biology, but suppose that such laws are not adequate in their current form, and must be enriched by further laws whose predicates are different from those of inert physics and chemistry.

It is not evident how a complete elimination of teleological expressions (concepts defined functionally) from biological theory can be pursued without forsaking a powerful and fruitful conceptual scheme for physiology, morphology, disease, and evolution. In cognitive science, a belief that biological systems, such as the mind/brain, are not wholly reducible to electronic circuitry, like computers, is a pervasive attitude that implicitly drives considerable polemic, but also much creative theorizing. Even if this sort of vitalism represents a lingering folk belief that science may ultimately seek to discard, it remains an important and perhaps indispensable cognitive heuristic for regulating scientific inquiry.

### 3.4. Are there folk theories of natural kinds?

So far, the line of argument has been that systematic biology and commonsense folk biology continue to share core-related concepts, such as the species, taxonomic ranking, and teleological causality. Granted, in science these are used more as heuristics than as ontological concepts, but their use allows and fosters varied and pervasive interactions between science and common sense. Still, systematic biology and folk biology are arguably distinct domains, which are delimited by different criteria of relevance.

This cognitive division of labor between science and common sense is not a view favored in current philosophy or psychology (see Dupré 1993 for an exception). More frequent is the view that in matters of biological systematics, science is continuous with folk biology, but involves a more

adequate elaboration of implicit folk meanings and “theories.” Deciding the issue is not so simple – in part because, as Bertrand Russell lamented: “One of the most difficult matters in all of controversy is to distinguish disputes about words from disputes about facts” (1958, p. 114).

Philosophers and psychologists have noted that no principled distinction between folk and scientific knowledge can be built on ideas of empirical refutation or confirmation, underdetermination, or going beyond appearance or the information given, or even toleration of internal contradictions and inconsistencies (Feyerabend 1975; Keil & Silberstein 1996; Kuhn 1962). Instead, I want to focus on three related differences between science and folk systems: integration, effectiveness, and competition. Concerning integration, it does appear that across all cultures there is some attempt at causal coordination of a few central aspects of life: bodily functioning and maturational growth, inheritance and reproduction, disease and death. But the actual extent of this integration, and the concrete causal mechanisms that effect it, vary widely in detail and coherency across cultures (and individuals, judging by informant justifications in the experimental tasks discussed in the preceding section).

Although the core concept of a generic species as a teleological agent may be universal, knowledge of the actual causal chains that linkup the life properties of a species can involve a host of vitalistic, mechanical, and intentional causes whose mix is largely determined by social tradition and individual learning experience (e.g., on disease, see Au & Romo 1996 and Keil 1994 for Americans, and Berlin & Berlin 1996 for Maya). Moreover, few, if any, commonsense accounts of “life” seek to provide a causal account of the global relationships linking (e.g., generating) species and groups of species to and from one another, although there may be various recurrent causal clusters and family relationships. Aristotle was possibly the first person in the world to attempt to integrate an entire taxonomic system.<sup>14</sup>

Concerning effectiveness, science’s aim is ultimately cosmic in that it is geared to generating predictions about events that are equally accurate, correct, or true for any observer. By contrast basic commonsense knowledge, driven by the folk core, has a more terrestrial aim: namely, to provide an effective understanding of the environment that allows appropriate responses. From an evolutionary standpoint, the structure from which we infer an agent’s environment must also be the one that actively determines the agent’s behavioral strategies (congruent actions and responses): “If the resulting actions anticipate useful future consequences, the agent has an effective internal model; otherwise it has an ineffective one” that may lead it to die out (Holland 1995, p. 34). Folk-biological taxonomies provide both the built-in constraints and flexibility adequate for a wide range of culturally appropriate responses to various environments. By contrast, scientific taxonomies are of limited value in everyday life, and some of the knowledge they elicit (e.g., that tree, bird, sparrow, and worm are *not* valid taxa) may be inappropriate to a wide range of a person’s life circumstances.

Concerning competition among theories, even in our own culture such competition only marginally affects the folk-biological core (Atran 1987b; Dupré 1981). A tendency toward cultural conservatism and convergence in folk biology may be a naturally selected aspect of the functioning of the folk-biology module. As in the case of language, the syn-

tactic structure is geared to generate fairly rapid and comprehensive semantic agreement, which would likely have been crucial to group survival (Pinker & Bloom 1990).<sup>15</sup> Fundamental conflicts over the meaning or extension of *tree*, *lion*, and *deer* would hardly have encouraged cooperative subsistence behavior.

All scientific theories may be characterized, in principle, in relation to their competition with other theories (Hull 1988; Lakatos 1978; Popper 1972). An intended goal of this competition is to expand the database through better organizing principles. This is the minimum condition for the accumulation of knowledge that distinguishes science as a Western tradition from other cultural traditions. For example, it is only in Europe that a cumulative development of natural history occurred that could lead to anything like a science of biology. Thus, the Chinese, Ottoman, Inca, and Aztec empires spanned many local folk-biological systems. Unlike Europe, however, these empires never managed to unite the species of different folk-biological systems into a single classification scheme, much less into anything like a unified causal framework (Atran 1990).

Finally, consider that a penchant for calling intuitive data-organizing principles “theories” may stem, in part, from a peculiar bias in analytic philosophy and cognitive psychology. This bias consists of using the emergence of scientific knowledge as the standard by which to evaluate the formation of ordinary knowledge about the everyday world. From an anthropological vantage, this is peculiar because it takes as a model of human thought a rather small, specialized, and marginal subset of contemporary thought. It is rather like taking the peculiar knowledge system of another cultural tradition, such as Maya cosmography, and using this to model human thought in general.

This bias to model human cognition on scientific thought is historically rooted in the tradition of Anglo-American empiricism, which maintains that science is continuous with common sense, both ontologically (Russell 1948) and methodologically (Quine 1969). It is supposedly a natural and more perfect extension of common sense that purges the latter of its egocentric and contextual biases, for “it is the essence of a scientific account of the world to reduce to a minimum the egocentric bias in [an everyday] assertion” (Russell 1957, p. 386). When faced with a choice between commonsense kinds and scientific kinds whose referents substantially overlap, people ought to pick the scientific kind, for “we should not treat scientists’ criteria as governing a word which has different application-conditions from the ‘ordinary’ word” (Putnam 1986, p. 498; cf. Kripke 1972, p. 315).

The belief that folk taxonomies are approximations to scientific classifications confounds two appropriate empirical observations and one inappropriate metaphysical supposition. The observations are that: (1) the terms for commonsense generic species and the species terms used in science are often the same; and (2) scientific classification did initially stem from commonsense classification. The erroneous supposition is that both terms denote “natural kinds,” and that people will refine their use of natural-kind terms as science improves because this is an inherent part of understanding what they “mean.” This entails that there is no a priori mental (“syntactic”) constraint on our use or understanding of biological kinds. There is only a semantic understanding that is determined a posteriori by scientific discoveries about the correct or true structure of

the world. In fact, neither the terms for generic species nor the species terms used in science denote natural kinds.

Consider: Mill (1843), who was one of Russell's mentors, introduced the notion of natural kind in the philosophy of science. Natural kinds were to be nature's own "limited varieties," and would correspond to the predicates of scientific laws in what was then thought to be a determinate Newtonian universe. Counted among the fundamental ontological kinds of this universe were biological species and the basic elements of inert substance (e.g., gold, lead).<sup>16</sup>

In evolutionary theory, however, species are not natural kinds. "Speciation," that is, the splitting over time of more or less reproductively isolated groups, has no fixed beginning and can only be judged to have occurred to some degree through hindsight. No hard-and-fast rule can distinguish a variety or genus from a species in time, although failure to interbreed is a good rule of thumb for distinguishing (some) groups of organisms living in close proximity. No laws of molecular or genetic biology consistently apply to all species and only to species. Nor is there evidence for a systematic deferral to science in matters of everyday biological kinds. This is because the relevance of biological kinds to folk in everyday life pertains to their role in making the everyday world comprehensible, not in making the cosmos at large transparent. When folk assimilate some rather superficial scientific refinements to gain a bit of new knowledge (e.g., whales and bats), these usually affect the antecedent folk system only at the margins.

In sum, a "scientific" notion of the species as a natural kind is not the ultimate reference for the commonsense meaning of living-kind terms. There is marked discontinuity between evolutionary and preevolutionary conceptions of species. Indeed, the correct scenario might be just the reverse. A notion of the species as a natural kind lingers in the philosophy of science and resolutely persists in psychology (Carey 1985; Gelman 1988; Keil 1995; Rey 1983; Schwartz 1979), which indicates that certain basic notions in science are as much hostage to the dictates of common sense as the other way around. So, to the questions: "What, if not natural kinds, are generic species?" and "What, if not a theory, are the principles of folk biology?" the answer may be simply "They are what they are." This is a good prospect for empirical research.

## Conclusion

The uniform structure of taxonomic knowledge, under diverse sociocultural learning conditions, arguably results from domain-specific cognitive processes that are panhuman, although circumstances trigger and condition the stable structure acquired. No other cognitive domain is invariably partitioned into foundational kinds that are so patently clear and distinct. Neither does any other domain so systematically involve a further ranking of kinds into inductively sound taxonomies, which express natural relationships that support indefinitely many inferences.

Although accounts of actual causal mechanisms and relations among taxa vary across cultures, abstract taxonomic structure is universal and actual taxonomies are often recognizably ancient and stable. This suggests that such tax-

onomies are products of an autonomous, natural classification scheme of the human mind, which does not depend directly on an elaborated formal or folk theory. Such taxonomies plausibly represent "modular" habits of the mind, naturally selected to capture recurrent habits of the world relevant to hominid survival in ancestral environments. Once emitted in a cultural environment, the ideas developed within this universal framework spread rapidly and enduringly through a population of minds without institutionalized instruction. They tend to be inordinately stable within a culture, and remain by and large structurally isomorphic across cultures.

Within this universal framework people develop more variable and specific causal schema for knowing taxa and linking them together. This enables people to interpret and anticipate future events in their environments in locally relevant ways. To be sure, there are universal presumptions that species-like kinds have underlying causal natures, and this drives learning. As a result, people across the world teleologically relate observable morphology, internally directed growth and transgenerational inheritance to developing ideas about the causal constitution of generic species. But no culturally elaborated theory of life's integral properties need causally unite and differentiate all such kinds by systematic degrees.

Thus, it is not the cultural elaboration of a theory of biological causality that originally distinguishes people's understanding of the species concept, taxonomy, and teleology, as these apply to (nonhuman) animals and plants from understanding basic concepts and organization of inert substances, artifacts, or persons. Rather, the spontaneous arrangement of living things into taxonomies of essential kinds constitutes a prior set of constraints on any and all possible theories about the causal relations between living kinds and their biological properties. This includes evolutionary theories, such as Darwin's, which ultimately counter this commonsense conception.

From a scientific standpoint, folk-biological concepts such as the generic species are woefully inadequate for capturing the evolutionary relationships of species over vast dimensions of time and space – dimensions that human minds were not directly designed (naturally selected) to comprehend. All taxa are but individual segments of a genealogical tree (Ghiselin 1981), whose branchings may never be clear cut. Only by laborious cultural strategies like those involved in science can minds accumulate the knowledge to transcend the bounds of their phenomenal world and grasp nature's subtleties. But this requires continued access to the intuitive categories that anchor speculation and allow more sophisticated knowledge to emerge, much as the universal intuition of solid bodies and contingent movement has anchored scientific speculation about mass, matter, and motion.

This does not mean that folk taxonomy is more or less preferable to the inferential understanding that links and perhaps ultimately dissolves taxa into biological theories. This "commonsense" biology may just have different conditions of relevance than scientific biology: the one, providing enough built-in structural constraint and flexibility to allow individuals and cultures to maximize inductive potential relative to the widest possible range of everyday human interests in the biological world; and the other, providing new and various ways of transcending those interests to infer the structure of nature in itself, or at least a nature

where humans are only incidental. Because common sense operates unaware of its limits, whereas science evolves in different directions and at different rates to surpass those limits, the boundary between them is not apparent. A research task of “the anthropology of science” is to comprehend this division of cognitive labor between science and common sense: to find the bounds within which reality meets the eye, and to show us where visibility no longer holds the promise of truth.

#### ACKNOWLEDGMENTS

The studies reported here were funded by the NSF (SBR 93-19798, 94-22587) and France’s Ministry of Research and Education (Contract CNRS 92-C-0758), with student support from The University of Michigan’s Culture and Cognition Program. They were codirected with Douglas Medin. Participants in this project on biological knowledge across cultures include Alejandro López (Psychology, Max Planck), John Coley and Elizabeth Lynch (Psychology, Northwestern University), Ximena Lois (Linguistics, Crea-Ecole Polytechnique), Valentina Vapnarsky (Anthropology, Université de Paris X), Edward Smith and Paul Estin (Psychology, University of Michigan), and Brian Smith (Biology, University of Texas, Arlington). I thank Medin, Dan Sperber, Giyoo Hatano, Susan Carey, Gerd Gigerenzer, and the anonymous referees for comments; thanks also to Estin and López for Figures.

#### NOTES

1. Thus, comparing constellations in cosmologies of ancient China, Greece, and the Aztec Empire shows little commonality. By contrast, herbals like the ancient Chinese *ERH YA*, Theophrastus’s *Peri Puton Istorias*, and the Aztec *Badianus Codex* share important features, such as the classification of generic species into tree and herb life forms (Atran 1990, p. 276).

2. By contrast, a partitioning of artifacts (including those of organic origin, such as foods) is neither mutually exclusive nor composed of inherent natures: some mugs may or may not be cups; an avocado may be a fruit or vegetable depending on how it is served; a given object may be a bar stool or waste bin depending on the social context or perceptual orientation of its user; and so on.

3. It makes no difference whether these groups are names. English speakers ambiguously use “animal” to refer to at least three distinct classes of living things: nonhuman animals, animals including humans, and mammals (the prototypical animals). The term *beast* seems to pick out nonhuman animals in English, but is seldom used today. *Plant* is ambiguously used to refer to the plant kingdom, or to members of that kingdom that are not trees.

4. Life forms vary across cultures. Ancient Hebrew or modern Rangi (Tanzania) include herpetofauna (reptiles and amphibians) with insects, worms, and other “creeping crawlers” (Kesby 1979), whereas Itzaj Maya and (until recently) most Western cultures include herpetofauna with mammals as “quadrupeds.” Itzaj place phenomenally isolated mammals like the bat with birds, just as Ro-faifo (New Guinea) place phenomenally isolated birds like casowaries with mammals (Dwyer 1976a). Whatever the content of life-form taxa, the life-form level, or rank, universally partitions the living world into broadly equivalent divisions.

5. In the logical structure of folk taxonomy, outliers may be considered monotypic life forms with only one generic species (for a formalism, see the Appendix in Atran 1995a).

6. Botanists and ethnobotanists tend to see preferred folk-biological groups as akin to scientific genera (Bartlett 1940; Berlin 1972; Greene 1983). Plant genera especially are often groups most easily recognized morphologically without technical aids (Linnaeus 1738). Zoologists and ethnozoologists tend to view them as more like scientific species, where reproductive and geographical isolation are more readily identified in terms of behavior (Bulmer 1970; Diamond 1966; Simpson 1961).

7. In a comparative study of Itzaj Maya and rural Michigan college students, we found that the great majority of mammal taxa in

both cultures correspond to scientific species, and most also correspond to monospecific genera: 30 or 40 (75%) basic Michigan mammal terms denote biological species, of which 21 (70%, or 53% of the total) are monospecific genera; 36 of 42 (86%) basic Itzaj mammal terms denote biological species, of which 25 (69%, or 60% of the total) are monospecific genera (Atran 1995a; López et al. 1997). Studies of trees in both the Peten rainforest and Chicago area reveal a similar pattern (Atran 1993; Medin et al. 1997).

8. Moving vertically within each graph corresponds to changing the premise while holding the conclusion category constant. This allows us to test another domain-general model of category-based reasoning: the Similarity-Coverage Model (Osherson et al. 1990). According to this model, the closer the premise category is to the conclusion category, the stronger the induction should be. Our results show only weak evidence for this general reasoning heuristic, which fails to account for the various “jumps” in inductive strength that indicate absolute or relative preference (Atran et al. 1997). Note also that we conducted separate experiments to control for the effects of linguistic transparency; for example, whether relations between generic species and life forms were marked (e.g., *catfish - fish*) or unmarked (e.g., *bass - fish*) had no effect on results (Coley et al. 1997).

9. The existence of universal, domain-specific cognitions is not tied exclusively, or even necessarily, to cross-cultural pervasiveness. The social subordination of women, for example, appears in all known cultures (i.e., it is a cultural “universal” in the sense of Lévi-Strauss 1969). It could be argued that this universal has some biological grounding. There is no reason, however, to attribute the varied ways people process this pervasive social phenomenon to a universal cognitive mechanism. Conversely, the ability to understand and develop mathematics may be rooted in some fairly specific cognitive mechanisms, with which humans are innately endowed (Gelman 1990). But, if so, many cultures do not require that people use this ability. Nor is it occasioned by every environment.

10. Each group was tested in its native language (Itzaj and English), and included a minimum of six men and six women on each task. The choice of groups of 12 or more people is based on pilot studies that indicate this is sufficient to establish a cultural consensus (Atran 1994). No statistically significant differences between men and women were found on the tasks reported.

11. For each subject, we have a square symmetric data matrix, with the number of rows and columns equal to the number of generic species sorted. Subjects’ taxonomic distance matrices were correlated with each other, yielding a pairwise subject-by-subject correlation matrix representing the degree to which each subject’s taxonomy agreed with every other subject’s taxonomy. Principal component factor analyses were then performed on the intersubject correlation matrix for each group of informants to determine whether or not there was a “cultural consensus” in informant responses. A cultural consensus is plausible if the factor analysis results in a single factor solution. If a single dimension underlies patterns of agreement within a domain, then consensus can be assumed for that domain and the dimension can be thought of as reflecting the degree to which each subject shares in the consensual knowledge (Romney et al. 1986). Consensus is indicated by a strong single factor solution in which: (1) the first latent root (eigenvalue) is large compared to the rest, (2) all scores on the first factor are positive, and (3) the first factor accounts for most of the variance. To the extent that some individuals agree more often with the consensus than others, they are considered more “culturally competent” with respect to the domain in question. An estimate of individual knowledge levels, or competencies, is given by each subject’s first factor scores. This represents the degree to which that subject’s responses agree with the consensus. That is, the pattern of correlations among informants should be based entirely on the extent to which each subject knows the common (culturally relative) “truth.” The mean of all first-factor scores provides an overall measure of consensus.

12. Different types of “scientific taxonomy” correlate differ-

## Open Peer Commentary

*Commentary submitted by the qualified professional readership of this journal will be considered for publication in a later issue as Continuing Commentary on this article. Integrative overviews and syntheses are especially encouraged.*

### The “core meme” meme

Robert Auger

King's College, University of Cambridge, Cambridge CB2 1ST, United Kingdom. [rva20@cam.ac.uk](mailto:rva20@cam.ac.uk)

**Abstract:** Differences in mutation rates, transmission chain-length, phenotypic manifestations, or the relative complexity of the mental representations in which they are embedded do not distinguish between “core” (intra-modular) and “developing” (inter-modular) memes, as Atran suggests. Dividing memes into types seems premature when our knowledge of mental representation is as imprecise as the unit of biological inheritance was in Darwin's time.

My admiration for Atran's work is considerable. Nevertheless, I do not believe that his distinction between “core” and “developing” memes splits the memetic universe into natural or even pseudo-natural (Boyer 1993) kinds. My challenge consists of suggesting the characteristics that supposedly identify core memes do not in fact do so.

First, do core memes necessarily exhibit reduced rates of mutation because they can rely on cognitive modules? Atran's argument seems to be that developing memes are usually involved in more complex representations than core memes because they are more often manipulated by metacognitive, cross-domain processing, whereas core memes rely on narrowly confined processing by individual cognitive modules. However, being subjected to multiple algorithmic transformations and connected to bits of information from various domains at the point of acquisition does not necessarily imply high mutation rates. First, core memetic representations may in fact be larger and more complex than developing memetic representations. I argue by analogy: it has proven more difficult for computers or robots to mimic universal, quotidian human behaviors (such as physical movement without bumping into walls) than sophisticated ones like chess-playing because extensive background knowledge of the world underpins these basic skills. Similarly, it is possible that we will find the fundamental components of human cognition – folk domains – to contain more complex information structures than scientific ones. Thus, it may prove that the conscious, memetic components of the “simple” things that children can do (e.g., intuitive physics) constitute only the tip of the cognitive iceberg.

Furthermore, mutation is a generational concept, and a memetic generation (i.e., the time spent residing in one mind before being transmitted to another) may be longer for core memes. It is now well recognized that information is often likely to be modified when recalled (Schacter 1996). Thus, heavily used information such as everyday core knowledge may be subject to more episodes of potential transformation – through recombination with other kinds of information in working memory – than infrequently recalled information, such as more specialized developing memes. We simply do not know enough about how memory and social learning work to make a general distinction between mutation rates in modularized versus more free-floating memes.

Second, is genotypic identity closer to phenotypic identity for core memes? By analogy to genes, I would argue the observable phenotype of a meme is the behavior it directs its host to perform. From Atran's perspective, the perception of the meme sender's behavior by the meme receiver is the phenotype, whereas from my perspective it is the behavior itself. If I am right, then the phenotype of both core and developing memes can be the same, and

ently with folk taxonomy, with cladistic taxonomies (based on strict phylogenetic branching) generally being the least correlated and phenetic taxonomies (based on relations among observable characters) being the most. Evolutionary taxonomies represent a compromise of sorts between cladistics and phenetics.

13. Apparent lack of taxonomically based diversity is not limited to Itzaj reasoning about mammals (they show the same pattern when reasoning about birds and palms; Atran, in press), nor is it limited to non-Western populations. In another series of studies exploring the impact of different kinds of expertise on categorization and reasoning about trees (Medin et al. 1997), we have found that parks and forestry maintenance workers responded significantly below chance on diversity items (Coley et al., in press). As with the Itzaj, justifications focused on ecological factors (e.g., distribution, susceptibility to disease) and associated causal reasoning. Another American group, consisting of taxonomists, sorted and reasoned in accordance with scientific classification. These results confirm the scientific reasoning patterns that were only inferred from the scientific classification in the mammal studies. Like American students on the mammal task, the taxonomists also had overwhelmingly positive responses on the diversity task. Differences in education did not appear to be significantly correlated with diversity or lack of diversity in the American populations (note also that López et al. 1992 found diversity with American 10-year-olds).

14. The situation is arguably similar for naive physics, not only between cultures, but within our own culture. DiSessa (1988) speaks of a “knowledge in pieces” involving concept clusters that reinforce and help to interpret one another to guide people's uninstructed expectations and explanations about many situations of potential relevance to them. Although there is appreciable diversity of expectations and explanations, there are strong tendencies toward the convergence of concept clusters across individuals (and presumably across cultures). These are fairly robust, even for people with formal or scientific education, in part because there is substantial overlap between scientific (Newtonian) and commonsense physics. The causal clusters that are formed, however, reflect local family relationships rather than global coverage: “The impetus theory is, at best, about tosses and similar phenomena. It does not explain how people think about objects on tables, or balance scales, or orbits” (diSessa 1996, p. 714).

15. There is also the cryptic notion of “tacit theory” that originally came from Chomskian linguistics. Generative linguistics rightly seem to consider this more of a throwaway notion than do some philosophers. Using “tacit theory” to assimilate universal grammar and universal taxonomy would wrongly entail assimilating a core module to an input module, and perhaps also to any complex biological algorithm (instinct) or automatic organizing process.

16. Aristotle first proposed that both living and inert kinds had essential natures. Locke (1848/1689) dubbed these unknowable kinds, “real kinds,” claiming that their underlying natures could never be wholly fathomed by the mind. Across cultures, it is not clear that inert substances comprise a cognitive domain that is conceived in terms of underlying essences or natures. Nor is it obvious what the basic elements might be, because the Greek *earth*, *air*, *fire*, and *water* are not universal. The conception of “natural kind,” which supposedly spans all sorts of lawful natural phenomena, may turn out not to be a psychologically real predicate of ordinary thinking (i.e., a “natural kind” of cognitive science). It may simply be an epistemic notion peculiar to a growth stage in Western science and philosophy of science.

can involve similar transfer mechanisms, such as a public utterance (e.g., “that’s a vulture” vs. “my totem is a vulture”).

Finally, transmission chains need not be shorter for core memes. In fact, even for Atran’s own examples, the reverse may be true. Transfer of a core meme for a generic species, he argues, typically takes place in a social context where one host passes the meme to another one “directly” as a token (e.g., by pointing). On the other hand, for a developing meme such as a factoid from a scientific program, the link between hosts is mediated by some artifact (e.g., a published paper), so that the meme must undergo several transformations in its life cycle between hosts (e.g., from mental representation to computer hard-disk to printed paper back to mental representation). In fact, publication makes possible a one-to-many mode of replication, because lots of people can read the same document. Thus, each individual in the population learning a developing meme may use the original source, whereas in the case of the core meme each replication involves a person passing the meme along in a sequence of dyadic social encounters. To reach a given level of endemism in a population, core memes may therefore require longer transmission chains. Furthermore, because mutations can compound in such chains, more variant core memes may be circulating at any given time in the population. Overall, the *average* rates of mutation for various core and developing memes may overlap to such a degree as to make their distributions indistinguishable.

These considerations run counter to the general claim that core memes are closer to genes, and hence better replicators, than developing memes. The implicit goal of Atran’s distinction seems to be to save at least some types of cultural knowledge from Sperber’s (1996) charge that mutation rates for all memes are too high for them to be considered replicators. I have argued that core memes do not necessarily exhibit lower mutation rates. In fact, a property distinguishing core from developing memes remains to be found. Yet Sperber’s general indictment is itself premature. Instead, a meme’s degree of mutability has to be determined in a case-specific fashion. In fact, empirically defined units of cultural transmission can show reasonably low mutation rates, despite no obvious reliance on the modular domains thus far identified in the literature (Aunger, in preparation).

Following Atran’s own logic, the meme meme, like the gene meme, is not a folk concept reliably acquired and replicated by cognitive modules evolved during hominid pre-history. As a result, it is conceptually slippery; because it is not tied to any particular domain, it is more easily subjected to analogical transfers between domains. In this case, the analogy between genes and memes as types of information is powerful indeed, and just where the analogy breaks down is unclear. Furthermore, as they are only now becoming part of an active scientific research program, the various conceptions of memes have not been tested for longevity, nor have they established a niche for themselves within a stable cultural complex. As a result, the meme meme remains fuzzy. I therefore argue that it is simply too early in the history of memetics as a science to begin taxonomizing memetic genera.

## Cultural transmission with an evolved intuitive ontology: Domain-specific cognitive tracks of inheritance

Pascal Boyer

Laboratoire Dynamique du Langage, Centre National de la Recherche Scientifique, MRASH, Lyon, France. [pboyer@mrash.fr](mailto:pboyer@mrash.fr)  
[www.ddl.mrash.fr/membres/~Boyer/homepage.html](http://www.ddl.mrash.fr/membres/~Boyer/homepage.html)

**Abstract:** Atran’s account of cultural transmission can be further refined by considering constraints from early-developed, domain-specific intuitive ontological understanding. These suggest specific predictions about the cultural survival of “memes,” depending on the way they activate intuitive

understanding. There is no general dynamic of cultural inheritance; only complex predictions for domain-specific competencies that cut across cultural domains.

Atran’s distinction between “core memes” and “developing memes” provides effective arguments and evidence for a non-Lamarckian approach to cultural evolution. “Cultural” representations are not a special kind of representation. The term denotes only some rough similarities between mental representations among members of a particular group. Now we cannot assume that the cause of people’s present representations is simply that they are copies of those acquired by former generations. Cultural input does not replicate “memes” so much as trigger complex inferences (Sperber 1985; Tomasello et al. 1993). So transmission results in the inferential creation of variants that are either discarded or passed on. Differential interpretation, recall, and transmission result in a differential spread of mental representations. Atran’s demonstration of such processes in biology may require further refinement if it is to be generalised to other domains of cultural knowledge.

This requires a closer focus on *acquisition* processes. The inferences that build cultural representations themselves depend on prior conceptual structures, among them an *evolved intuitive ontology*. Developmental evidence demonstrates the early development and constraining power of ontology as (1) a set of broad categories such as *person, animal, plant or artefact*, and (2) inferential principles that focus on aspects of objects identified as members of these categories, for example, intuitive inferences about physical or biological properties, numerosity, or the mental causes of observable behaviour. So ontology is not just a catalogue of kinds of stuff in the world, but also a set of implicit theories about their underlying properties and definite expectations about their observable features.

Cultural input includes cues that trigger specific ontological categories and associated inferential principles. In some domains, cultural input is attended to inasmuch as it constitutes an *enrichment* of spontaneous ontological assumptions. For example, early acquisition of culture-specific counting systems activates numerosity principles present in infancy (Wynn 1992). This also applies to the specific cultural representations about the “self,” the link between consciousness and various organs or bodily properties, and so on. Such speculations can take very different forms in different social groups. These all imply and use principles of intuitive psychology, and generally fill in empty place-holders in these principles. For example, intuitive psychology assumes that beliefs affect intentions, but it underspecifies the mechanisms generating intentions in the first place. Another example is kinship and social categories, where children acquire local categories that fill in conceptual slots postulated but not specified by intuitive ontology (Hirschfeld 1996).

The role of intuitive ontology is also crucial in understanding the spread and recurrent features of cultural representations that *violate* expectations of intuitive ontologies, such as religious representations. Spirits that go through physical obstacles, immortal gods, and statues that listen to prayer are all contradictions of intuitive expectations about agents and artefacts. An interpretation in terms of cultural cues and intuitive inferences would predict that the most culturally widespread religions assumptions are those that (1) include attention-grabbing violations of some intuitive expectations, and (2) maintain activation of nonviolated principles (Boyer 1994b). This is confirmed by the cross-cultural recurrence of such representations as well as by experimental studies of concepts of superhuman agents and recall for counter-intuitive representations (see e.g., Barrett & Keil 1996).

Finally, some cultural representations that displace intuitive expectations and require additional inferential principles are found only in highly institutionalised contexts with regular cognitive training such as scientific theorising or systematic theology. These contexts provide tools for the *metarepresentation* of beliefs that do not accord with intuitive ontology.

Describing folk versus scientific biology, Atran deals mainly



with the first and third kinds of situation: enrichment (in folk biology) and displacement (in scientific knowledge) of intuitive biological expectations. His distinction between “core memes” and “developing memes” is adequate for the domain at hand, but needs some modification to apply to other domains of culture. Also, the distinction between core and developing memes may fail to take into account causal dependencies between the different types of cultural acquisition. For example, developmental and anthropological evidence would suggest the following speculative predictions concerning the “cultural survival” of particular mental representations:

[P1] Representations have “cultural fitness” to the extent that they trigger an enrichment of skeletal principles of intuitive ontology;

[P2] Representations that do not instantiate [P1] are “fit” to the extent that all relevant nonviolated principles can be activated;

[P3] Representations that instantiate neither [P1] nor [P2] have fitness inasmuch as there is institutional support for their metarepresentation.

These functionally different processes can be found combined in some domains of cultural representations. What seems to be a culturally integrated domain may in fact activate different domains of intuitive ontology. “Religion,” for example, activates intuitive categories of *agency* for its ontology, intuitive concepts of *family* and intuitive coalitional strategies for ethnic boundaries rephrased as religious differences (“our” religion vs. “theirs”), and intuitive apprehension of social interaction for what looks like religion-based morality. Inferential principles differ from one intuitive domain to the next and therefore govern cultural evolution in different ways because of their different functional characteristics. So the transmission of different aspects of a cultural system may involve parallel “cognitive inheritance tracks.” The dynamic properties of these inheritance tracks probably vary and hence activate domain-specific capacities or principles.

## Culture in cognitive science

Don Dedrick

Philosophy Department, University of Victoria, Victoria, British Columbia, Canada V8W 3P4. [ddedrick@uvic.ca](mailto:ddedrick@uvic.ca)

**Abstract:** A concern for cultural specificity, the staple of traditional anthropological research, survives the transition to domain-specific accounts of cognitive structuring such as Atran’s, and is arguably better off for having made the transition. The identification of domain-specific processes provide us with criteria for sorting cultural differences and integrating cultural concerns within cognitive science.

Anthropologists and psychologists once believed in the cultural relativity of various conceptual phenomena. For example: different languages possessed different color words because the speakers of those languages had different interests, purposes, social organizations, and ecologies. [See Saunders & van Brakel: “Are There Nontrivial Constraints on Colour Categorization?” *BBS* 20(2) 1997.] The psychologists Roger Brown and Eric Lenneberg advanced a version of the relativist hypothesis for color names in 1954 and, in 1953, V. Ray had summarized the anthropological case as follows: “Each culture has taken the spectral continuum and divided it upon a basis which is quite arbitrary except for pragmatic considerations” (1953, p. 102). Times change. By the middle of the 1970s, as a consequence of Berlin and Kay’s *Basic colour terms* (1969) and Eleanor Rosch’s related work (1972) on color prototypicality, people were talking about the *universality* of color names, about “constraints” on color naming.

Atran’s target article charts a similar course for the investigation of folk-biological taxonomy and ranks from a relativism grounded in cultural utility to a domain-specific, core knowledge position according to which, as Atran says: “The uniform structure of taxo-

nomic knowledge, under diverse sociocultural learning conditions, arguably results from domain-specific cognitive processes that are panhuman, although circumstances trigger and condition the stable structure acquired” (Conclusion, para. 1). The idea that it is circumstances that “trigger and condition” a stable structure that is innate is pure Chomsky (1972). It is also an idea that has appeared, explicitly, in color language research (Berlin & Kay 1969). What does this mean for culture-driven explanations of cognitive phenomena? In 1976 the anthropologist Marshall Sahlins observed that:

Giving mind all the powers of “law” and “limitation” has seemed to place culture in the position of submission and dependence. The whole vocabulary of underlying laws accords the mind all force of constraint, to which the cultural can only respond, as if the first was the active partner of the relation and the second passive. (1976, p. 3)

Sahlins was writing about Berlin & Kay’s color-naming claims, but he might have been responding to the views of Atran for whom “cognition constrains culture.” For both cases it seems that culture has ceased to have a substantive explanatory role. This was Sahlins’s worry and it is not much out of date today. Do we yet have an answer to the following question: What role does (or can) culture have in cognitive science if one accepts this sort of model?

It is clear that the idea of culture as some sort of unified whole is abandoned. Call this a “molecular” as opposed to a “holistic” conception of culture. On the view developed by Sperber (1994), culture is essentially produced by a large group of interacting modular systems, some perceptual, some conceptual, some meta-conceptual. Yet all this more-or-less hardwiredness does not determine some “uniform culture” – as Atran’s domain-specific model for folk-biological ranks so nicely illustrates. There is culturally specific selection of taxa at any rank, as well as the up/downgrading in importance of particular taxonomic ranks relative to “cultural criteria” (sect. 2, para. 1). A concern for cultural specificity, a staple of traditional anthropological research, survives the transition to domain-specific accounts like Atran’s and is arguably better off for having made the transition.

A great difficulty when it comes to holistic conceptions of culture is that any difference identified between any two groups seems significant. Thus, in research on color names prior to the work of Berlin and Kay (and in some that follows), highly specific facts about a color lexicon could serve as evidence for a purely cultural explanation of color vocabulary. If every difference counts, this is almost certain to be true. But why should every difference count? Because culture is a unified whole, we are led around in a circle. And worse, there seems to be no way, from within holism, to step outside the circle and into cognitive science.

Atran argues that folk biology is constrained in terms of the taxonomic structures it uses and these, in turn, place constraints on the development of science that is itself a particular cultural product. More generally, we might want to speak of domain-specific processes imposing constraints on the introduction of cultural material as theoretically/explanatorily relevant. In other words, the identification of domain-specific processes provides us with criteria for sorting cultural differences and avoiding the pitfalls of cultural holism. The discovery of universal rank (for folk biology) and basicness (for color terms) were the major breakthroughs in developing an understanding of categorization in these domains and they are breakthroughs in large part because they reduce the number of dimensions in which cultural differences matter. With universal taxonomic structure fixed, culturally specific difference is set in relief. We are now able to see that the most culture-specific values associated with color for any group appear at nonbasic levels (in language that may be tied quite explicitly to things, to nature, to ritual, etc.) Similarly, as Atran argues, the folk-specific level of biological taxonomy is the one where classification is most fully contextualized (for reasons that are pretty clearly “cultural”) for people like the Itzaj. Particularity in both these domains is a complement to and not a competitor with more general purpose categorical structures that are likely grounded in evolutionary history.

Atran's discussions of both science and totemism suggest a different and perhaps more welcome interpretation of Sahlins's (1976) concern with constraints of mind. Rather than viewing culture as the passive partner in a dance with universal cognitive structures, we could view cultures (or better, people) as active in *exploiting* these stable structures. If nothing much turns on the way we describe this situation, so much the better.

Atran imports, for his own use, a variety of theoretical notions from various domains in cognitive science. He is also critical of other importations – most notably from the philosophy of science and cognitive psychology (sect. 3.4). What is remarkable throughout is the integration of these more global concerns with detailed fieldwork. The author has brought to our attention a model according to which cognition constrains culture in rather specific ways. It is also a model in a different sense: of how culture can matter to cognitive science.

## Doubts about a unified cognitive theory of taxonomic knowledge and its memic status

Roy Ellen

Department of Anthropology, Eliot College, University of Kent at Canterbury, Canterbury, Kent CT2 7NS United Kingdom. r.f.ellen@ukc.ac.uk

**Abstract:** The evidence for a panhuman, cognitively rooted, essence-based concept of basic natural kind and for certain prototypical phenomenal forms is increasingly compelling, but there remain doubts as to whether these two elements combine with a principle of taxonomy to form a unified, domain-specific theory in the way Atran claims. The appropriateness of the notion of meme can also be questioned, as can the assertion that humans are always grouped in ethnobiological classifications in unambiguous contrast to other animals.

There are at least three main objectives in Atran's multi-stranded argument: to confirm an underlying universal model in folk-biological classification, to show how in the development of Western scientific knowledge this model has been modified, and to demonstrate how – despite the claims made for the “naturalness” of contemporary biological taxonomy – it has yet to come to terms with post-Darwinian insights concerning the mutability of species and the phylogenetic relations between them. I confine my comments to the first two.

Atran claims that “the uniform structure of taxonomic knowledge [of plants and animals], under diverse sociocultural learning conditions, arguably results from domain-specific cognitive processes that are panhuman, although circumstances trigger and condition the stable structure acquired” (Conclusion). I suggest that the evidence for a *unified* theory that reflects an integrated and completely domain-specific cognitive base remains to be proven. The proposed elements of such a theory are the universal recognition of basic “essence based” units modelled on a cognitive predisposition to identify natural “things,” the recognition of cognitively rooted (i.e., noncultural) phenomenal forms, and the mechanism of taxonomy.

There is no inherent difficulty with the first (cf. Ellen 1993; 1996), though given what Atran says about the arbitrariness of the species concept in post-Darwinian biology and its divergence from core folk conceptions, I think the emphasis at the phylogenetic generic level, though focal, is somewhat overplayed, and the apparent distinction between vertebrate and angiosperm species and the rest implausibly convenient. Neither do I have a problem acknowledging that certain phenomenal forms are remarkably stable cross culturally in a way that suggests that they register underlying cognitive prototypes. There seems every likelihood, for example, that there exists an “algorithm for animacy” (sect. 1.3; cf. Reed 1988). Because hominids have evolved in environments that display a particular phylogenetic and phenomenal discontinuity, it is not entirely surprising that they should demonstrate a capacity

to (a) use a notion of natural kind that assists the management of diversity, and (b) recognise more diffuse prototypes in non-cultural ways (e.g., “animal,” “plant,” perhaps “tree,” “bird,” “fish”). Such artifacts of cognition are logically different from “life-forms,” however, in the sense developed by Berlin (1972; 1992; Berlin et al. 1974). The latter vary cross-culturally (Note 5), but do not always partition “the living world into broadly equivalent divisions.” The notion of life-form relates to linguistic and categorical discrimination (and to “rank”).<sup>1</sup>

There can also be little doubt that people classify living things into increasingly inclusive groups, and that this provides a powerful inductive framework for making systematic inferences about the properties of organisms. But this need not imply taxonomy in the formal or domain-specific sense. Systematic contrast and class inclusion are present across a number of domains (see e.g., Lancy & Strathern 1981). It is particularly striking in plants and animals because of their “thinginess” and because they are the outcome of an evolutionary process that is reflected in patterned physical and behavioural resemblances. In the domain of living kinds, these tendencies converge in a particular way, not because of obvious features of the mind that does the classifying, but because of regularities in the objective world that is classified and to which the mind responds.

Folk biology may well be a core constellation of knowledge, even a “meta-representational model,” which, from an evolutionary point of view, can be considered a “core module” with a “default” pattern most recognisable in the culture of small-scale subsistence populations. Some elements of the folk biology “module” may well prove to be domain-specific and the outcome of natural selection, in that the knowledge organised through a particular set of cognitive skills and prototypes itself constrains and facilitates broadly similar ways in which all people understand and respond to the environment. However, to describe such intuitive biology as a “core meme” is to be deliberately provocative. In its totality “folk biology” cannot be “an innately determined cognitive structure” (sect. 1.3), and the idea of meme as we have received it from Dawkins (1976) implies something empirical that can be subjected to the forces of evolution in a manner in which the abstract second-order construct of “folk biology” cannot. We must ask why an aggregate of the complexity of “folk biology” should be a meme rather than a part of one or a collection of several. The cognitive strategies that underlie folk biology encourage a constellation of knowledge for which the boundaries are not always clear. Why should selective pressure be operating on the body of knowledge as a whole? The Darwinian logic implies that selection operates only on measurable behavioural outcomes of the application of biological knowledge and on individuals who are the vehicles for particular cultural traits. Moreover, this knowledge is not carried around in its entirety in the heads of individuals, but is socially distributed. The things we call ethnobiological *classifications* are an emergent product of applying core folk biological knowledge. I have described this as *prehension*: those empirical processes determined by the interaction of knowledge, context, purpose, and innate cognitive tools that give rise to particular classificatory outcomes (Ellen 1993, p. 229). Memes are notoriously slippery customers and we are probably dealing with at best a misleading analogy here.

Atran no longer thinks that folk taxonomy defines the inferential character of folk biology as he had suggested in Atran (1990); nor do his recent findings uphold the customary distinction between general-purpose and special-purpose classifications (sect. 2.2). This is consistent with the results of my own ethnobiological ethnography (e.g., Ellen 1993, pp. 123–24). Nuauulu, like Itzaj Maya, do not “essentialize ranks,” which would violate their primary concern with “ecological and morpho-behavioural relationships” in favour of abstract properties. The development of worldwide scientific systematics has explicitly required rejecting such relationships (sect. 2.1.2.3) with their cross-cutting classifications. The empirical ethnographic reality is rather of a single dynamic conception of the relations between categories, which allows for

the generation of particular “classifications” depending on context. Thus, the variable position of palms in ethnobotanical schemes is an excellent example of the preeminence of local and cultural considerations, and of some general fundamental ambiguity, as well (Ellen, in press). In positing a universal “abstract taxonomic structure,” the approach all too often seems to be to delete features of people’s classifying behaviour of living organisms that do not fit the expected pattern, until such a pattern is obtained.

There are also difficulties with Atran’s generalisations regarding the concept of rank (as indicating “fundamentally different levels of reality”) in organising the domain of living things. Ranks remain very difficult to establish cross-culturally as commensurate entities. Beyond the principle of successive inclusivity and the basic level, the concept is tricky to defend as a universal and hard-wired cognitive tendency. Ontological categories such as “folk kingdom” exist, in the sense that plant and animal are recognised (if not named) in virtually all cultures. But although certain life-forms are remarkably constant (e.g., “tree”) many categories that contrast with them are very inconstant, and distinguishing between “life-forms” and “unaffiliated generics” is not always easy. Whatever the content of life-form categories, they are not intrinsically “taxa,” and one can question the usefulness of the concept in certain ethnographic contexts where nonliterate modes of organising knowledge prevail (Ellen 1993, p. 116). Moreover, the “kind of relationship that links ranks is ruthlessly binary, and in the Nuaulu case it is difficult to infer a permanently-encoded rank order from a string of transitive relationships (Ellen 1993, p. 88). Successive inclusive division does not necessarily provide “levels.” As a description of what is going on here, it is preferable to speak of “degree of inclusiveness,” which leaves aside the judgment as to how the categories might be ranked with different degrees of inclusion (Ellen 1993, p. 91).

Finally, Atran claims that “no known aboriginal culture . . . believes that humans are animals or that there is an ontological category undifferentiated between humans and animals” (sect. 1.3) Given his back-tracking on the primacy of “general-purpose schemes” this assertion seems inconsistent. Many cultures have cosmological schemes and practical behaviours that stress the animality of humans. This is particularly so with hunting and gathering peoples, and underpins totemic ideas. Although it is unlikely to exclude classifications that contrast animals with humans, the latter polarity is much more typical of agricultural peoples where “nature” is more firmly defined as an external other (Ellen 1993, pp. 97 and 197; Ingold 1996; Karim 1981, pp. 4, 188).

#### NOTE

1. Thus, though the basic image prototype of “tree” may have existed for millions of years, the life-form category and term seem relatively recent (Witkowski et al. 1981), its earliest labelling appears to have involved functional considerations reflected in tree/wood polysemy. Some life-forms, it appears, are more natural than others.

## Folk metaphysics and the anthropology of science

Michael T. Ghiselin

*Center for the History and Philosophy of Science, California Academy of Sciences, San Francisco, CA 94118. mghiselin@casmil.calacademy.org*

**Abstract:** Atran’s treatment of classification suggests a need to recognize the difference between ontological categories and less metaphysically fundamental distinctions. The shift that scientists have made from classes to individuals may not be as pervasive as he proposes, and the same may be said for the abandonment of essences. It is also possible that the sort of causality that is of concern to scientists plays a role in folk classification.

As a theoretician of systematics, I am more than a little bothered by Atran’s suggestion that the plant-animal dichotomy represents

a distinction between ontological categories. It seems to me that this is simply a deep cut within the same ontological category. As I see it, both plants and animals fall under the broader taxon of living things, which is likewise not an ontological category. Although references to sensitive plants and to animals that photosynthesize are out of the ordinary, they are not treated as being based on category mistakes. It is not like saying that some plant is two hours high, or that the lifespan of an animal weighs 2 kilograms (Ghiselin 1997).

Nonetheless, it is possible that in folk metaphysics people do behave as if plants and animals belonged to different ontological categories. It seems to me, however, that in this case at least some of the confusion about categories is in the minds of the students of folk classification. On the other hand, the distinction between substances and properties is a legitimate categorical one, and everyone seems to make it, perhaps instinctively. The distinction, which Atran recognizes, between classes and individuals in the broadest ontological sense, is even more fundamental. Treating species and higher taxa explicitly as concrete, particular things, spatiotemporally restricted, without essences or defining properties, and not referred to by laws of nature, underscores the apparent difference between folk taxonomy and folk metaphysics on the one hand, and scientific taxonomy and scientific metaphysics on the other. The Linnean hierarchy is now conceived of in terms of parts incorporated in wholes, not classes included in classes.

Nonetheless, the shift that scientists have made does not give us something that is altogether alien to the physics and metaphysics of our daily lives. At the organismal level, we think of individuals as a matter of routine, especially our relatives, friends, enemies, and pets. One does not have to be a professional butcher or anatomist to think of an organism as being made up of components. That John’s right hand is a John is considered silly, irrespective of whether we know that it is a category mistake.

Likewise, at supra-organismal levels, we are familiar with nuclear families, extended families, tribes, and other composite wholes. Granting that, it seems by no means unreasonable to hypothesize that our cognitive faculties include whatever it takes to think about both classes and individuals, and to do so much as modern systematic biologists do. There is some developmental evidence that the two are to some extent distinct, insofar as whole-part logic seems to mature somewhat earlier than does the logic of classes. Classes and supra-organismal wholes are often confused, but then again, the distinction is sometimes recognized when taxonomic (not ontological) categories are often referred to by metaphorical or analogical reference to classes of individuals. The levels of kingdom, cohort, family, and so on have wholes with parts – not classes – as their members. A kingdom that is composed of duchies is not a class of duchies; a cohort is a military unit, not a kind of soldier, and a family is a socio-economic and reproductive whole, not a kind of anything.

Atran’s suggestion that we biologists have given up essences altogether is somewhat misleading as stated. For example, the class of species and the class of organisms definitely have defining properties, and although one may not want to call the definitions essences, the basic point remains that it is the taxa that have been deprived of their essences, rather than the (taxonomic, not ontological) categories at which they are ranked. But I wonder to what extent folk taxa really are treated as having essences in the sense that natural kinds are supposed to have some kind of essence. We do not attribute an essence, or an intensional definition, to any particular organism or other individual. None of my properties are defining of me; any of them could have been otherwise, and I have changed a great deal during the course of my life. On the other hand, we do expect people and other organisms to remain more or less consistent in their behavior, and not ordinarily undergo vast and rapid changes in personality. Both scientists and philosophers have mistaken the taxa of systematic biology for natural kinds, and the extent to which the folk metaphysics that underlies folk taxonomy really presupposes that the taxa are natural kinds is still an open question. One reason I say this is that even quite young peo-

ple are perfectly aware of the fact that animals procreate much as we do, and that they often live in family groups having some analogy with our own.

The hypothesis that we have an innate disposition to classify according to the sort of hierarchy that Atran describes ought to be taken very seriously indeed. Our ancestral environments were certainly such that they provided strong selection pressures in favor of being able to classify animals and plants. But how much detail has been bred into us, in other words, how much the oxymoronic notion of a “synthetic a priori” is to be taken seriously, is open to serious doubt. As a fall-back position we can suggest that the system in question is the product of capacities and dispositions that are widely used and that folk taxonomies are the product of something that is more of a “general purpose” adaptation. How about folk anatomies and folk sociologies?

Another point that bothers me is Atran’s emphasis on induction as the basis of classification. Naive inductionism as a basis for explaining the goals and methods of scientific classification has long been discredited, but it seems to be a part of the folk epistemology that naive scientists are inclined to apply. Scientists identify the underlying causes of the order that they make out of nature, and restructure their classifications accordingly. The reasons for preferring a classification that is etiological, rather than phenomenal or symptomatic, should be obvious to every scientist. In folk, and pre-Darwinian taxonomy the underlying causes are perhaps assumed to exist, but the groups are treated for the most part as if they were natural kinds. Nonetheless, it would seem that however much folk taxonomies distinguish between sows and boars, they put them together with piglets, much as they associate men, women, and children. One might wish to take a harder look at folk taxonomy, and how it interacts with scientific, with the hypothesis in mind that we have some sort of “module” for causality.

## Folk biology and external definitions

James A. Hampton

Department of Psychology, City University, London, EC1V 0HB United Kingdom. [j.a.hampton@city.ac.uk](mailto:j.a.hampton@city.ac.uk). [www.city.ac.uk/psychology](http://www.city.ac.uk/psychology)

**Abstract:** Atran’s thesis has strong implications for the doctrine of externalism in concepts (Fodor 1994). Beliefs about biological kinds may involve a degree of deference to scientific categories, but these categories are not truly scientific. They involve instead a folk view of science itself.

The way people understand and categorize the natural kinds of the biological world has been the subject of much heated debate in psychology. There have been those such as Keil (1989), and Atran himself, who have argued for a specialized conceptual module designed specifically to attend to theoretically relevant information in the stimulus input to identify categories of living things. Hence the evidence for very early differentiation of living and nonliving kinds by infants, and of the later use of deep causal structure rather than surface similarity in making inductive generalizations.

Equally influential has been the notion of psychological essentialism introduced by Medin and Ortony (1989), which is the hypothesis that people believe folk-biological kinds to have essences that have a causal role in producing the similar physical phenotypic appearance and structure of the organisms of a particular type. Belief in such essences appears to be much stronger for biological kinds and inorganic substances than for other natural language terms such as artifacts. (The evidence for how tightly people may hold such beliefs has recently been challenged, see Hampton 1995; 1998.)

Both of these psychological approaches lend themselves to an alliance with the philosophical doctrine of *external definitions*, expressed in the recent *BBS* target article by Millikan [A Common Structure for Concepts of Individuals, Stuffs, and Real Kinds

21(1) 1998]. The human mind/brain is assumed to have evolved to be able to “track” externally defined types. Put simply, our cognitive representation of a class has to be specified independently of what it is that the representation represents. Cognitive science must first determine the real nature of kinds in the world and then describe the ways in which people represent those kinds psychologically and how they come to acquire such representations. Defining the kinds purely in terms of internal conceptual representations can lead to a multitude of problems (Fodor 1994).

Atran makes the excellent point that neither of these theories of concepts may take for granted that there is a real world of scientifically respectable categories such as *species* that can be used by the theorist to ground our conceptual categories of biological kinds. First, to provide an account of evolution of different forms from a common ancestor, it is clearly not possible for a biological kind to have a fixed essence. Second, folk-biological terms such as *tree*, *sparrow*, or *fish* often do not correspond to monovalent terms in any scientific account. Third, different scientific purposes may require different taxonomic structures. Whatever it is that external definitions are intended to offer to a theory of concepts, it is clear from Atran’s arguments that it is *not* a grounding in the real nature of the world – at least not as it is understood by current science.

Atran’s comparison of Mayan and American folk biology is interesting, but ultimately frustratingly difficult to interpret. The research described here (sect. 1.2.2.1) is perhaps illustrative of the difficulties of cross-cultural research in general. To make the inductive task meaningful for the two cultures, it was apparently necessary to ask the Itzaj about susceptibility to diseases of three essential parts of animals or plants, whereas the Americans were asked about the likelihood of a type having a particular disease, protein, or enzyme labelled by a letter. Materials clearly have to be made comparably meaningful for the two groups, but there is a danger of circularity here, if by rendering the materials equally meaningful one also renders their inductive power the same. In this research, there were notable differences in responding between the groups, which Atran tends to ignore in favor of outlining the similarities.

In Western culture, it appears that there is an important influence of what we might call “folk science” on the use of folk-biological terminology. One owes some deference to what one may believe (or may have been taught) science has to say about living kinds. Children are taught in school that whales are not fish (although they are not taught that there is no such category as fish). At the same time, individuals must defer to the naming practices of their linguistic community, which will themselves frequently vary from context to context.

It is interesting that, with the ready availability of wild life films on television, it is no longer necessary for people to accept many of these categorizations on trust. To see whales caring for their calves, surfacing for air, and singing to each other is to understand in a direct way about their important difference from other creatures of the deep. We no longer need to defer to science; we can base our knowledge on evidence that we ourselves can also understand. Kalish (1995) asked people to say whether a dispute about the class (e.g., “elephant”) to which some animal belonged was one that could always be settled as a matter of fact, or whether it was a matter of a difference of opinion that could not be resolved. He found that more than 25% of the judgments about animals were considered unresolvable by fact. Language use therefore has an uneasy relation with science. We may be prepared to alter our categories when science directs us to knowledge that is incompatible with our existing usage, but only in cases where that knowledge is seen as relevant. By and large, language users retain the right to use terms in ways that are subject to social negotiation within a much broader society, in which the scientific community is but one small voice.

## Informal biology is a core domain, but its construction needs experience

Giyoo Hatano

Department of Human Relations, Keio University, Tokyo, Japan 108. [giyoo-h@qb3.so-net.ne.jp](mailto:giyoo-h@qb3.so-net.ne.jp)

**Abstract:** Although humans are endowed with domain-specific constraints for acquiring informal biology, its construction requires considerable experience with living things and their cultural representations. Less experienced adults may not know what constitutes generic species, and young children may rely on personification rather than category-based inference. Atran's postulate of the living-kind module that promptly produces universal folk taxonomy does not seem tenable.

In this commentary I would like to examine Atran's ideas about innate, domain-specific constraints for folk-biology based on our studies of young children's naive biology (see Hatano & Inagaki 1996 for a summary). Like Atran, I assume that informal, everyday, or intuitive biology is a core domain of thought – a knowledge system that deals with aspects of the world important for the survival of the human species and is therefore shared, to some extent, by adults and older children both within and between cultures. Also like Atran, I assume that humans are endowed with domain-specific constraints for acquiring information biology and thus acquire its initial, rudimentary form early and without difficulty. However, my conceptualization of the domain-specific constraints is considerably different from his.

Atran seems to equate the constraints with an autonomous, natural classification scheme of the human mind (i.e., the living-kind module), which promptly produces a more or less universal taxonomy of plants and animals. This taxonomy is composed of several hierarchical levels or ranks, with the focus on generic species that are supposed to share a unique underlying nature or essence. In contrast, I believe that the domain-specific constraints serve merely to direct attention to living things and encode their essential properties, and also to restrict the range of hypothesis space to be explored for biological phenomena. The constraints help human beings construct informal biology as a framework for predicting and interpreting behaviors of animals and plants, but the construction process requires considerable experience with living things (including humans) and their cultural representations. This implies that biological classifications may vary between, and, to no lesser extent, within cultures.

I certainly agree with Atran that human beings, across cultures, divide entities in the world into four ontological categories, that is, humans, other animals, plants, and nonliving things including artifacts. Humans also tend to apply vitalism as causality to nonintentional behaviors of living things, which defines biology as an autonomous domain. This may be because, as Atran claims, humans have domain-specific schemata of mind through which they “conceptually perceive” (sect. 1.3) different aspects of the world differently. Alternatively, humans can learn to distinguish humans from all other things by characteristic visual and auditory cues, animals from inanimate objects primarily in terms of the spontaneous movement, and plants from nonliving things because plants grow and change. The domain-specific constraints facilitate these differentiations by directing attention to such distinctive features as movement and growth.

My disagreement with Atran mainly concerns classification within the folk kingdom. Atran claims that the biological world is partitioned into essence-based generic species and their groups. Generic species are more or less universal across cultures, and often correspond to scientific genera or species (at least for conspicuous organisms), because they are direct products of the living kind module. Atran presents data allegedly showing that generic species are preferred for making biological inferences among both Lowland Maya and Midwest Americans.

I do not think the above experimental findings allow us to conclude that the American students preferred generic species in

making biological inferences. First, because the experimental materials were selected predominantly on linguistic grounds, the students' responses could be based primarily on linguistic knowledge that different nouns imply a larger difference than different qualifiers. Second, which rank is privileged for inductive projection depends on the property to be projected and its characterization. For example, if participants are told that all sparrows have thin bones (convenient for flying), they may project this property to a group of flying birds, if not all birds. Third, we cannot generalize from the results with conspicuous organisms to the entire folk kingdom. It is conceivable that American adults have almost no differentiation among generic species, life forms, and intermediate groups for less conspicuous organisms (e.g., bugs, mushrooms).

I must also doubt that the folk-biological taxonomy can always be acquired and used so readily. Indigenous adults in small communities such as the Lowland Maya people are experts on living kinds in their ecological niche. It is therefore not surprising that they have a developed folk taxonomy. In contrast, adults living in a technologically advanced society may have impoverished knowledge, especially about less conspicuous animals and plants. They may still have a preference for the generic species rank for inference, but this has little effect on their everyday reasoning if they do not know what constitutes generic species. Even if humans are able to develop a general-purpose taxonomy with rank of generic species as the core, its effective use presupposes a lot of opportunities for watching and talking about each taxon.

Young children everywhere have very limited taxonomical knowledge. Thus, though they may have some abstract or global understanding of what animals or plants are like, they lack concrete or specific pieces of knowledge about each living thing. Therefore, they are not prepared to classify entities at the rank of generic species or to use favorably the rank of generic species.

Young children's small experiential databases may require them to rely on personification rather than category-based inference. Young children are so familiar with humans that they can use their knowledge about humans as a source for analogy when they attribute properties to less familiar animate objects or predict the reactions of such objects in novel situations. It should be noted that children do not use knowledge about humans indiscriminately.

Similarity-based inference or analogy is a domain-general mechanism. Personification uses knowledge about humans, a different ontological category from animals or plants, as its base. This must be weaker than domain-specific, taxonomy-based inference. Hence as soon as they acquire rich knowledge about taxa at an intermediate or life-form level, children come to rely more on category-based inference. In this sense, taxonomy is a necessary condition for domain-specific, truly biological inferences, but it takes time to acquire.

## Xenophobia and other reasons to wonder about the domain specificity of folk-biological classification

Terence E. Hays

Department of Anthropology and Geography, Rhode Island College, Providence, RI 02908. [thays@grog.ric.edu](mailto:thays@grog.ric.edu)

**Abstract:** Atran adds a synthesis of much of the literature on folk-biological classification to important new experimental data relevant to long-standing inferences about the structure of folk taxonomies. What we know about such systems is somewhat overstated, and key issues remain unresolved, especially concerning the centrality of “generic species,” the primacy of “general purpose” taxonomies, and domain specificity.

Atran's target article is a tour de force, synthesizing much of the important literature from the past several decades relating to folk-

biological classification. His new experimental data, including some from Western “folk” (partially redressing a major gap in our knowledge of folk systems) adds significantly to the resolution of several issues. However, there are at least implied overestimations of what we have learned so far, and some crucial issues remain clouded.

**How much and how little do we know about “the folk”?** Recurring phrases such as “people the world over” may lead the non-specialist reader to believe that a substantial number and globally representative sample of cases exists but, as Berlin (1992) makes clear, the number of well-studied folk-biological classifications is still woefully small. Nor can we comfortably accept *passim* speculations regarding early childhood development (e.g., sect. 1.1, para. 7). Virtually the only field study of non-Western children’s folk (botanical) categories (and a very limited one at that) is the Tzeltal Maya case cited (Stross 1973). Later (sect. 1.3, para. 23) Atran appropriately underscores the need and relevance of data on cultural transmission, to which I would add an emphasis on *un-schooled* children who have not grown up with picture books (especially of animals) readily labelled with “generic species” names to assist in their language learning.

**The centrality of “generic species” and “general purpose” classifications.** A key notion in Atran’s general argument is that of “essences” (sect. 1.2), which underpins the purported centrality of “generic species.” Left unaddressed are cases of “species transformations” from folk-biological systems (e.g., Bulmer 1968; Dwyer 1976b; Healey 1978/1979). Some of these clearly refer to growth stages of insect forms, but not all are so easily incorporated into “essentialist” thinking. In any event, they warrant consideration here. Atran’s experiments on “preferred” levels (sect. 1.2.2) provide important support for Berlin’s (1992) long-standing sense that “folk generics” (to use his term) are the “basic building blocks” of folk-biological taxonomies (though this is a separable matter from that of “essences”). More ambiguous are the results of Atran’s experiments regarding “intermediate level” categories (sect. 2.1.1.2). In the examples given, “felines and canines” in Michigan and “arboreal animals” for Itzaj Maya, Atran proposes “cultural” (read “cultural ecological”) influences on folk classification that introduce a “nonscientific dimension,” yielding differences from scientific classifications. Could one not legitimately consider these categories as “special purpose” ones, “piggybacking” (in Atran’s term) on a “general purpose” classification that indeed accords well with that of scientific zoologists?

**Domain specificity.** Perhaps the issue of broadest relevance to cognitive science is that of the purported domain specificity of folk biological classification. In developing the notion of folk biology as a “core domain” (sect. 1.3), Atran looks for suggestions from “naive physics” (para. 2) after earlier asserting that folk classification of artifacts is *not* like folk classification of plants and animals (sect. 1.2.2). Surely the former turns on “naive physics”?

Finally, Atran may be reaching too hard for distinctive features of folk reasoning regarding nonhuman living kinds in his claim (sect. 1.3, para. 9) that, unlike animals and plants, “humans are individuated . . . in accordance with inferred intentions rather than expected clusters of body parts.” First, *when they are known well*, animals surely *are* individuated in just such terms, as with pets: “Morris [my cat] is punishing me for leaving him alone in the house all day.” If this is simply a “humanizing” of selected examples of the animal kingdom, then is the xenophobe simply “animalizing” selected examples of our species *when they are not known well*? As much as we might wish it were otherwise, in addition to universally used folk categories of sex, “ethnicity” and “race” likewise persist as categories rooted in “clusters of body parts” despite concerted efforts, such as those currently being undertaken by the American Anthropological Association, to convince “the folk” that they should abandon such “nonscientific” concepts.

## Atran’s biodiversity parser: Doubts about hierarchy and autonomy

Eugene S. Hunn

Department of Anthropology, University of Washington, Seattle, WA 98195-3100. [hunn@u.washington.edu](mailto:hunn@u.washington.edu)

**Abstract:** Atran argues that an autonomous ethno-biological information-processing module exists. This module imputes a “deep causal essence” to folk-biological taxa and uses a hierarchy of taxonomic ranks. I argue that Atran’s own data suggest that rank is not an essential feature of the ethno-biological module, and that ethno-biological causal essences may be generalized to other domains and vice versa, limiting its autonomy.

Atran’s summary of the implications of ethno-biological research for our understanding of innate information processing “modules” is multifaceted, which makes it difficult to sort the wheat from the chaff in his argument. I believe the comparative ethno-biological evidence for how people of diverse cultures speaking radically distinct languages and inhabiting natural environments of all descriptions partition their experience of the domains of plants and animals makes sense only if we postulate, as Atran has, an innate “natural kind” recognition module in the human brain. As with natural language, children learn far too easily to recognize and name hundreds of folk species of plants and animals, and are apparently inclined to do this even in depauperate natural environments such as the inner city.

I am not convinced, however, that a taxonomic hierarchy of discrete ranks need be part of this hypothetical biodiversity recognition module. Atran himself is of two minds on this point. He first asserts that:

This “default” folk-biological taxonomy . . . is composed of a fairly rigid hierarchy of inclusive groups of organisms, or taxa. At each level of the hierarchy, the taxa, which are mutually exclusive, partition the locally perceived biota in a virtually exhaustive manner. Lay taxonomy, it appears, is everywhere composed of a small number of *absolutely distinct* [my emphasis] hierarchical levels, or ranks. (sect. 1, para. 2)

In this he follows Berlin (1992; Berlin et al. 1973). He argues further that these ranks are unique to folk biological classifications, and that, for example, “there is no ranked system of artifacts: no inferential link . . . spans both *chair* and *car*, or *furniture* and *vehicle*, by dint of common rank” (sect. 1.1., para. 2). He notes that nonbiological concepts such as *chair* or *mud* lack deep causal essences (sect. 1.2.1., para. 5). He attributes specific inferential properties to the folk-biological hierarchies that, he asserts, are nowhere extended to nor encountered in classifications of people or artifacts. “Conceiving of an object as a plant or animal seems to carry certain assumptions that are not applied to objects thought of as belonging to other ontological categories, like person, substance, or artifact.” (sect. 1.1, para. 4). Yet further into his argument he admits that “I no longer think that folk taxonomy defines the inferential character of folk biology as strongly as I indicated in a previous work [i.e., Atran 1990] (sect. 2, para 1). He then cites his own evidence to show that causal inferences from life-form taxa to taxa of lower rank do not always reflect consistent principles of inductive inference, specifically, in the case of “diversity-based reasoning” (Osherson et al. 1990). “But contrary to my earlier assumptions (Atran 1990), our studies show this is not the case. Itzaj, and probably other traditional folk, do not essentialize ranks . . . do not presume that higher-order taxa share the kind of unseen causal unity that their constituent generic species do” (sect. 2.1.3, para. 1). In fact, there is substantial evidence gathered by other ethno-biologists that these “life-form” taxa are a motley crew of categories grounded in whatever association is handy, which may be morphological similarity, ecological contiguity, common utility, or some other symbolic linkage (Clément 1995; Hunn 1982; Randall & Hunn 1984).

This diversity undermines Atran’s assertion that folk-biological taxonomies have nothing in common with classifications of arti-

facts or of persons. I would like to suggest in conclusion that we not seal off the biodiversity parser too tightly from the rest of the human cognitive apparatus. I believe Atran overstates the case when he avers: “Yet no known aboriginal culture . . . believes that humans are animals or that there is an ontological category undifferentiated between humans and animals” (sect. 1.3, para. 9). This discounts the evidence of “animism,” a mode of religious expression grounded in the notion that people, animals, plants, and other “animate” forces of nature share an essential causal nature, to wit, intelligence and will, which demands that people respect these other beings as they would respect or be respected by other people. In this case it appears that an ethnopsychological “model of the mind” (D’Andrade 1995, pp. 158–69) designed to make sense of what other people are doing may govern people’s interactions with other species. On the other hand, Hirschfeld’s (1996) fascinating studies of early childhood constructions of “racial essences” show that humans may be all too ready to generalize from species essences to racial essences, thereby generating stereotypical expectations for the behavior of those people who fall outside the charmed circle of personal acquaintance. Curiously, in common with basic plant and animal taxa, the number of people we treat as individuals may be limited by the “magic number 500” (Berlin 1992, pp. 96–101; Humm 1994).

In sum, ethnobiological essences “misapplied” to people may be responsible for ethnic stereotyping, whereas ethnopsychological essences “misapplied” to animals and plants may have motivated sustainable human-environment interactions for much of human history. If we exaggerate the autonomy of the ethnobiological module, we will miss such intriguing connections.

## A neurocognitive mechanism for folk biology?

Remo Job and Luca Surian

*Dipartimento di Psicologia dello Sviluppo e della Socializzazione, Università di Padova, I-35131 Padova, Italy. remojob@psico.unipd.it; surian@psico.unipd.it*

**Abstract:** Atran’s putative module for folk biology is evaluated with respect to evidence from patients showing category-specific impairments for living kinds. Existing neuropsychological evidence provides no support for the primacy of categorization at the generic species level. We outline reasons for this and emphasize that such claims should be tested using inductive reasoning tasks.

Atran makes the strong and nontrivial claim that folk biology relies on universal, domain-specific reasoning processes and that such processes are based preferentially on categorization at the level of species. These constraints on biological reasoning do not result from domain-general learning mechanisms that pick up covariation of features in the world, but rather from a specialized module evolved to deal with life processes. One important set of data for evaluating claims about the modularity of cognitive subsystems is provided by the dissociation patterns found in neurological patients.

If the primacy of “species level” categorization for biological reasoning is caused by a specialized module, and this modular organization is honoured in the organization of the brain, then we should expect to find patients exhibiting a pattern of preserved and impaired conceptual knowledge that highlights selective damage at this level. As can be seen in Table 1, a comprehensive examination of the neuropsychological literature on category-specific impairments shows that by far the most common selective impairment of semantic knowledge points to a dissociation between living and nonliving objects; the former is of course the actual domain of a putative module for “folk biology.” Most patients exhibit a disproportionate deficit in knowledge about living things, but the opposite pattern, that is, a disproportionate deficit

in knowledge about nonliving objects, has also been reported. Such double dissociations allow us to rule out that category-specific impairments are an artefact of uncontrolled covariations of factors such as perceptual similarity, familiarity, and visual complexity (see Farah et al. 1991 and Sartori et al. 1993 for studies that have controlled for such variables).

These findings support the idea that the animate-inanimate distinction is ontologically fundamental and calls for separate dedicated brain systems. Although this implies that the human cognitive system has a core domain of biological kinds that are at least in part, hardwired, there is no evidence to support the primacy of categorization at the generic-species level proposed by Atran. Dissociations of semantic knowledge about categories more specific than animate versus artefactual have only been found in three studies, two of them reporting a deficit at the level of kingdoms (i.e., animals only: Caramazza & Shelton, in press; Hart & Gordon 1992) and one suggesting a dissociation at the level of life-forms (i.e., vegetables and fruit but not trees: Hart et al. 1985). No study has yet reported a category-specific impairment showing a dissociation for living things at ranks lower than life forms.

There are several possible reasons for the difference between the neuropsychological evidence and Atran’s findings. The least interesting one would be that the anatomical and physiological structures of the brain prevent category-specific impairment from being detected at low hierarchical levels, although dedicated neural architectures may exist for such fine-grained distinctions. Second, species-specific concepts may have psychological prominence in inductive reasoning, but no dedicated brain circuits: specialization of brain circuits may occur only at the general level of “information about living things.” This would weaken the case for the biology module envisaged by Atran. Third, a deficit at the level of species or life forms may have passed unnoticed because patient performance was averaged over items belonging to living kinds or artefacts. Furthermore, materials have typically not included sets of folk-specific items and the consistency of responses to individual items has not been reported systematically, thus masking an uneven profile at the level of generic-species. Fourth, neuropsychological studies and Atran’s investigation differ substantially in the kinds of task they use.

Atran’s major piece of evidence for the primacy of species in the organization of biological knowledge comes from an inductive reasoning task. Informants had to judge whether or not it was appropriate to generalize a nonperceptual attribute of an object named at a certain rank to all objects belonging to a higher rank. Such tasks have not yet been used in neuropsychological studies; so far, these have instead favoured identification tasks, such as naming from pictures or definitions, and the verification of categorical relations. Patients with category-specific impairments can typically say that a picture of a cat or a horse depicts an animal, but they have severe difficulties in naming those pictures at the species level. When presented with verbal definitions of animals they may not retrieve their names or judge the truth of statements about well-known attributes. In sum, although they can still say something about the membership of a species to its higher ranks, they have lost most information that is distinctive of species. Thus, the reported deficits in neuropsychological patients do not appear to be selective for certain species. From the point of view of psychological essentialism, neuropsychological tasks seem best suited to tapping knowledge about the identification function of concepts, whereas inductive reasoning tasks seem more apt to assess knowledge about conceptual cores.

It is an empirical question whether there are indeed persons that have a specific deficit in biological reasoning and whether such a problem always co-occurs with a category-specific impairment for living things. Inductive reasoning tasks could turn out to be sensitive to semantic impairments that cannot be detected by tasks traditionally used in neuropsychological investigations. Reasoning tasks have already been used successfully with persons with autism to reveal a selective deficit in mental states concepts (Baron-Cohen 1995; Surian & Leslie, in press). Very strong sup-

Table 1 (Job & Surian). *Category-specific impairments for living and nonliving kinds*

Articles	Patients	Living kinds			Man-made
		Animate things <sup>1</sup>	Animals	Vegetables	
Warrington & McCarthy (1983)	VER				X
Warrington & Shallice (1984)	JBR	X			
	SBJ	X			
	KB	X			
	JNG	X			
Hart et al. (1985)	MD			X	
Warrington & McCarthy (1987)	YOT				X
Basso et al. (1988)	NV	X			
McCarthy & Warrington (1988)	TOB	X			
Pietrini et al. (1988)	RM	X			
	JV	X			
	Michelangelo	X			
Sartori & Job (1988)	Michelangelo	X			
Silveri & Gainotti (1988)	LA	X			
Farah et al. (1989)	LH	X			
Hillis & Caramazza (1991)	PS	X			
	JJ				X
Sartori et al. (1992)	Giulietta	X			
Hart & Gordon (1992)	KR		X		
Sacchett & Humphreys (1992)	CW				X
Laiacona et al. (1993)	FM	X			
	GR	X			
	SB	X			
Sheridan & Humphreys (1993)	SB	X			
De Renzi & Lucchelli (1994)	Felicia	X			
Moss & Tyler (1997)	ES				X
Caramazza & Shelton (in press)	EW		X		
		17	2	1	5

<sup>1</sup>Items used to assess a deficit in this category typically include birds, mammals, fish, and a number of plants.

port for Atran's claims would come from a group of patients showing a selective deficit in reasoning about biological processes without comparable deficits in other core cognitive domains such as psychological or mechanical causation and without a severe loss of distinctive information about species. In sum, we think that current neuropsychological evidence provides mixed support for a folk biology module, but more compelling evidence could be gained from future studies specifically designed to address such hypotheses.

### Folk taxonomies and folk theories: The case of Williams syndrome

Susan C. Johnson

Department of Psychology, University of Pittsburgh, Pittsburgh, PA 15260.  
susanj@pop.pitt.edu

**Abstract:** Work with people with Williams syndrome is reviewed relative to Atran's claim that the universality of taxonomic rank in the animal and plant domains derives from a biological construal of generic species. From this work it is argued that a biological construal of animals is not necessary for the construction of the adult taxonomy of animals and therefore that the existence of an animal (or plant) taxonomy cannot be taken as evidence of a biological domain.

Atran's target article is filled with intriguing ideas concerning the relationship between innate cognitive modules and cultural belief systems. Many of the ideas – such as the logical nature of rank, perceptual detectors for living kinds, and core versus developing memes – deserve further thought and consideration. Indeed, Atran makes a convincing argument that systems of taxonomic rank are used universally to organize both the animal and plant worlds and that these systems of rank are logically distinct from common hierarchical systems. However, his argument that animal and plant taxonomies together comprise a single universal domain of folk biology is somewhat less convincing. Two related questions arise from his argument: (1) Is a biological construal of either animals or plants a prerequisite for the existence of animal or plant taxonomies? (2) Can we individuate conceptual domains on the basis of structural features alone?

**A teleological-vitalist biology.** Atran suggests that the system of rank found within both animal and plant taxonomies derives from a universal teleo-vitalist causal construal of generic species (sect. 1.2.1, para. 4; sect. 1.3, para. 1; sect. 3.4, para. 3).<sup>1</sup> This suggestion derives largely from the developmental literature in which a variety of attempts to characterize children's earliest biological theories include proposals of vitalism (Hatano & Inagaki 1994), teleology (Keil 1994), and a combined teleological vitalism (Carey 1995) in which animals and plants are united by a vitalistic construal of life; that is, the belief that bodily processes exist for the purpose of maintaining life, where life is a nonmechanistic, irreducible, vitalistic force.



Although these proposals represent advances in the effort to characterize the possible contents of a biological domain, they have not resolved questions about its origin. Nor have they addressed the relationship between the structure of animal and plant taxonomies on the one hand and the conceptual analysis of members of those taxonomies on the other. Furthermore, recent work with people with Williams syndrome suggests that it is possible to acquire quite sophisticated, taxonomically based knowledge of animals and their properties in the absence of biologically specific notions of life, death, the body-machine, or even the superordinate category of living thing (Johnson & Carey, under review).

Williams syndrome (WS) is a rare neurodevelopmental disorder of genetic origin (Frangiskakis et al. 1996) resulting in mental retardation despite spared language acquisition (Bellugi et al. 1993). Individuals with WS are often characterized as displaying “cocktail party syndrome” – the tendency to speak in lengthy detail with only superficial content, a tendency that Johnson and Carey have found extends to their concepts of animals. Participants with WS excelled at deciding whether birds, worms, and ragdolls have hearts or breathe. In fact, their inductive patterns of so-called biological properties of animals more closely resembled those of normal adults than those of normally developing children of equivalent verbal mental age. Relative to the patterns reported by Carey (1985), they showed subtle taxonomic distinctions typically seen only in normal adults, such as that between vertebrates and invertebrates.

However, the same individuals showed little evidence that they conceptualized animals and plants as the same kinds of things or that they conceptualized life as a distinct causal force. The majority gave behavioral interpretations of death, describing death in terms of departure or sleep, rather than the breakdown of the bodily machine. They were largely animistic, judging that inanimate things like mountains and the sun are “alive,” but plants are not. They failed to attribute properties like reproduction to plants. They also claimed that a costume could change an animal’s species identity.

This ability to acquire subtle, taxonomically based knowledge of animals and their properties in the absence of either the superordinate category of living thing or the biologically specific concept of life raises interpretative questions about Atran’s informants. What evidence does Atran offer that vitalistic construals are part of either the animal or plant taxonomies of the Itzaj Maya, let alone both taxonomies? Without direct evidence of such content-specific inferences it may be premature to conclude that these taxonomies represent two branches of a single domain rather than two structurally similar, but conceptually distinct domains; one based on animals and the other on plants.

#### NOTE

1. More specifically, Atran argues that teleo-vitalistic construals of generic species lead to a type of essentialism that is a defining characteristic of the domain. However, essentialism, though present in childhood, has not emerged as a strong candidate of biologically specific reasoning. Empirical evidence suggests that essentialistic reasoning applies to other natural kinds as well, such as substances/minerals (Gelman & Markman 1986), and perhaps even artifacts (Bloom 1995b). This commentary accordingly focuses on the non-essentialistic construals of vitalism.

## Faculty before folk

Justin Leiber

Philosophy Department, University of Houston, Houston, TX 77004.  
jleiber@uh.edu bentley.uh.edu/philosophy/leiber/jleiber.htm

**Abstract:** Pace Atran, (1) folk physics, (2) folk biology, and (3) folk psychology rest on informationally encapsulated modules that emerge before language: a gifted autistic person who can *see* objects and animals perfectly well can nonetheless be incommunicatively *mind blind*.

Many now question the power of culture to put a fundamental, endlessly variable stamp on our cognitive, affective, and sensory

faculties, but Atran proposes an anthropology that *can* contribute to a cognitive science that expects complex, native, modular faculties, rooted in a genotypical faculty development that is tuned, maintained, and created by natural selection.

Atran suggests that we share a biological module primed to individuate animal and plant species, essentially and teleologically, thus centering (sect. 1.3) a superordinate and subordinate hierarchy. Atran surveys a wide range of evidence for this claim, particularly that words for species are short, “lexically unanalyzable” morphemes whereas higher and lower categories are compound and derivative. His research suggests that the Itzaj in the Maya rainforest have much the same folk biology as Midwestern Americans (the skeleton of the old anthropology rattles here: Itzaj folk biology is much more detailed and “ecologically sound,” whereas Midwesterners, though they speak of oak and elm, cannot tell them apart, labeling as “some sort of tree” what an experienced woodsman or a trained biologist could identify). Itzaj insistence that bats are birds is ecologically sound; Midwesterners parrot that bats are mammals, but they see flying rodents rather than flying proto-primates). The folk biology module is distinct from the folk physics module that primes our instinctive understanding of the inorganic world and from the folk psychology module that grounds our understanding of persons.

Atran’s “core domain” modules, however, while they “share much with Fodor’s input modules,” (sect. 1.3) are really very different. They are not informationally encapsulated; Atran’s modules talk to each other. Now we are in trouble. A Fodorian visual module zips retinal irradiations through rapid stages into outputs in which we recognize, say, a moving, three-dimensional, inorganic object (a rock hurtling at my face), a rabbit running by (pace Quine 1960), or a person glaring at me with mayhem on his mind. The neonate has rudimentary folk physics, flinching when large objects approach, expecting a ball that rolls behind a screen to reappear, and so forth. The neonate has rudimentary folk zoology as well, keying to characteristic animal expectations. The neonate coos, smiles, and attends eagerly to anything like a smiling human face (the effect most triggered by a simple oval face outline, two large dots and a nose line, with a curved smile line).

By the time the child can walk, well before language is obtained, the visual module is in place. Individual persons (and, pace Atran, individual animals), animal kinds, and physical objects are tracked, individuated, recognized, and understood. (Infants born with cataracts must have them removed within that first year to develop normal vision.) There will of course be little more fine tuning, and words will get attached to previously recognized persons, animals, plants, and objects. (The “theory of mind” module that undergirds intentional perception is not wholly functional until the third year or so, and will benefit from labels in the local language for the things it already perceives.) Curiously, according to Atran, Fodor’s concrete example of visual input modularity is animal species perception of *cows* (Fodor 1983, p. 48), and Fodor parallels this module with the language input module that converts sound streams into parsed sentences (which Atran wholly concedes is “informationally encapsulated,” sect. 1.3). So the perceptual/cognitive, modularized, encapsulated, proclivities from which an Aristotle can abstract an explicit folk physics, folk biology, and folk psychology are formed before language and culture can take hold. This is why generic species names like *cow* are “lexically unanalyzable,” mere labels for what we already automatically recognize as opposed to “animal,” “quadruped,” or “spotted cow.”

Autistic people provide but one of many reasons for skepticism about Atran’s claim that “naive physics, intuitive psychology or folk biology” are unencapsulated. As research of the last two decades shows, autistic people *perceive* folk physically and biologically, but their stunted “theory of mind” module is bootless (Baron-Cohen 1995). Animal husbandry professor Temple Grandin (1995), who has worked wonders in designing a third of the cattle slaughtering facilities in the United States, heroically exemplifies this point. Where we *see* intentional, affective persons, Grandin *sees* naught and, in her bewildered blindness, she *feels* like a visitor from Mars.

If our theory of mind module were not substantially encapsulated, we could just *tell* Grandin how to understand what is going on with other people intentionally and affectively,” but because we just *see* it (and *hear* it, etc.), we cannot.

Why does Atran go to such pains to dismiss encapsulation (and native faculty psychology as well)? If the modular encapsulation story is basically true, then people (whether Maya or Midwesterner) cannot tell the anthropologist much about what is going on. Nor will their *culture* – meaning their *consciously expressed beliefs* collectively forged and transmitted in their ecological setting – play the revelatory and fundamental role that Atran sees for it.

This may also account for the strident, care-worn, and eventually preposterous orgy of relativism, antimaterialism, and science-bashing that surfaces at the end of Atran’s paper. The Itzaj have the right and most useful biology for folk so placed (vitalism and dualism are right for humans; persons are not animals or still less, meat machines)! (sect. 3.3). “By contrast, scientific taxonomies are of limited value in everyday life and . . . inappropriate to a wide range of a person’s life circumstances” (sect. 3.4, para. 5). To say this is to deify “culture” as *what all the folk personally know*. Perhaps this is appropriate for tribal societies, but it is nonsense to talk this way about modern societies that are maintained by and depend vitally on an enormous body of specialized scientific and technological know-how. In *my* everyday life I am continually relying on this elaborate culture. I do not know how to tell an elm from an oak, but the “linguistic division of labor” makes me confident of the reference. I do not know what particular microbe is causing my illness or what drugs might cure me, but I am confident that its scientific taxonomy is available and will prove valuable in diagnosis and cure. I have more confidence in this than in folk remedies, and when the latter do work, I expect an explanation in nonfolk biochemistry.

## The source of universal concepts: A view from folk psychology

Angeline Lillard

Department of Psychology, University of Virginia, Charlottesville, VA 22903-2477. [lillard@virginia.edu](mailto:lillard@virginia.edu) [faraday.clas.virginia.edu/~asl2h/](mailto:faraday.clas.virginia.edu/~asl2h/)

**Abstract:** The evidence Atran uses to support innate biological principles could just as well support learning, just as in another realm often cited as a candidate for innate knowledge, “naive psychology.”

Atran claims that his results support the notion of an innate biology: a predetermined tendency to classify the biological world in certain ways. Such nativist theories are currently under discussion for several domains, particularly biology, psychology, physics (for a review, see Wellman & Gelman 1992; 1998). Unfortunately, nativist claims are often made without a clear specification of what innate means, but the sense that comes across in Atran’s target article is that of hardwired propensities to conceive the world in particular ways. However, when people conceive the world in particular ways, another possible reason is because the world really is that way, and people everywhere tend to pick out those common features.

I have explored these issues with reference to one of the other “Big Three” proposed innate knowledge domains: naive psychology (Lillard 1997; 1998). Several theorists have proposed that knowledge about other people’s mental states and their relations to the world is a product of innate modules (Baron-Cohen 1995; Fodor 1992; Leslie 1994). For example, Leslie conjectures that when someone observes an agent’s action, an innate processor automatically computes the agent’s intention. People see others’ behaviors in a particular way (in terms of intention) because of how their brains are wired. If this is so, people everywhere should see behaviors in terms of underlying intentions. However, when one

looks outside an American frame of reference, one sees notable differences in the propensity to attribute or discern intentions. Whereas Americans are very oriented to figuring out the mentalistic reasons for behaviors and will even supply such reasons for people they do not know (Malle 1996), other people appear to be reluctant to surmise about others’ mental states:

For Samoans . . . according to Ochs (1988), minds are unknowable and thus not relevant. Because motives are not important, children in Samoa do not try to get out of trouble by saying, “I did not do it on purpose,” as [European-Americans often] . . . do; instead they deny having done the deed at all. Paul (1995) claims for the Himalayan Sherpas “a query . . . about how they attribute intention would yield meager and disappointing results” (p. 19); “they do not, or will not, or cannot talk much in abstract or objective terms about motive or intention in ordinary life” (p. 21). (Lillard 1998, p. 13)

This is the case for at least six other cultures (Lillard 1998) and probably many more. People in several Asian cultures tend to explain behaviors in terms of external factors (situations), whereas Americans tend to use internal explanations (for a summary, see Lillard 1997). Hence in the domain of naive psychology, propensities that theorists claim are innate may stem instead from cultural norms.

Such differences in folk psychologies across cultures do not support the idea that folk psychology is hardwired. Yet Atran shows that biological classification systems are *similar* across cultures and suggests that this indicates that some aspects of folk biology are hardwired. Extrapolating to folk psychology, one might claim that although some aspects of folk psychology differ between cultures, some similarities in how people view others could be candidates for hardwired knowledge (Harris 1995; Wellman 1995). Two good places to look for hardwired universals are other primates and very young children. An example would be social referencing inhuman infants. Human infants seem to understand that an adult’s facial and verbal expression toward an object has implications for how the infant should treat that particular object (Baldwin & Moses 1994; Mumme et al. 1996). Although rigorous evidence from other cultures is not yet available, perhaps such abilities are hardwired. Other possible universals (candidates for hardwiring) might be the perception of pain or other physiological states in others.

But do such universals stem from innate understandings, or do they stem from general cognitive processes that are applied to universal patterns of evidence, patterns that afford the same conceptions everywhere? People everywhere probably realize that if someone is walking along and then suddenly starts screeching and hopping on one foot, he has stepped on something and his foot hurts, but this awareness may well result from experiencing and observing such scenarios, not from an innate concept of pain. The concept stems from one’s own experience of how the world is, not from innate knowledge.

Learning can also explain the data Atran presents. Whether Mayan or American, one learns early in life that individuals of a species beget other individuals of that species. Cats have cats, and dogs have dogs. Furthermore, one could learn early on that members of species are similar in broad habits and behaviors. There is no need to call the propensity to see such patterns “innate.” The developmental data Atran draws on to support his claims of innateness are more supportive of learning: 3-year-olds do less well than 4-year-olds, who do less well than 6-year-olds, who do less well than adults. Although these differences could result from younger children having more trouble with other aspects of the task (memory, concentration), it is more likely that they simply have not learned as well as adults have how the biological world is most suitably organized.

## The case for general mechanisms in concept formation

Kenneth R. Livingston

Department of Psychology and Program in Cognitive Science, Vassar College, Poughkeepsie, NY 12604-0479. [livingst@vassar.edu](mailto:livingst@vassar.edu)  
[depts.vassar.edu/~cogsci/livingston.html](http://depts.vassar.edu/~cogsci/livingston.html)

**Abstract:** Reasons are given for believing that it is premature to abandon the idea that domain-general models of concept learning can explain how human beings understand the biological world. Questions are raised about whether the evidence for domain specificity is convincing, and it is suggested that two constraints on domain-general concept learning models may be sufficient to account for the available data.

The idea that the mind is comprised of a set of evolved, special purpose, domain-specific modules has become fashionable in recent years (Cosmides 1989; Fodor 1983; Pinker 1997; Shepard 1987). Some of these claims (e.g., Fodor 1983) are relatively modest in that they suggest that such domain-specific modules are few in number and limited to input-output functions; cognitively central functions like concept learning or reasoning are explicitly excluded. Other renditions of the story are more sweeping and suggest that even these seemingly general-purpose, higher-order processes (or at least some of them) are actually prepared by evolution to operate as they do (Cosmides 1989; Pinker 1997; Plotkin 1994). Atran positions himself in this latter group, making the case that the conceptual system that organizes biological knowledge is built on a naturally selected "core meme" (cf. Lumsden & Wilson 1981), that serves to direct human perception of and reasoning about objects in the domain of living things. The evidence and argument offered in support of this claim is complex, but not, in the end, convincing. The reasons are as multifaceted as the arguments themselves, but space precludes attention to all but a few key points.

First are data from studies of peoples in two different cultures claiming to show that in spite of differences in the kinds of experiences they have had with the biological world, people give a privileged place in their reasoning about that world to the generic-species rank. Atran argues that domain-general models of concept acquisition cannot be reconciled with this finding. For example, he notes that Americans label the majority of the species they encounter on nature walks as "tree," a life-form level classification, and cannot tell the difference between beech and elm trees. Nevertheless, they expect that the important biological regularities in the world are at the level of beeches and elms, not tree, just as their more ecologically experienced counterparts among the Maya do.

The observation is interesting, but it is not clear that it should be considered inconsistent with a domain-general model of concept learning. Atran seems to reason as follows. Rosch et al. (1976) find that categories at the life-form level (e.g., tree or fish) meet the criteria for being at the so-called basic level for their American subjects in their laboratory studies. This is the same level at which American students label things on nature walks. It is therefore the level at which they structure the world perceptually and conceptually and should accordingly be the preferred level for making inductive inferences. But it is not the preferred level for induction, so the preferred level must be specified a priori.

The problem with this argument lies in the inference from how the domain is labeled or described verbally to how it is understood or conceived. Sloman et al. (1997), for example, have found striking dissociations across cultures in how labels are applied to the artifact category "containers." But the patterns of sorting and classification of these categories is almost identical across those same cultures. Because it would be awkward to argue for the existence of an evolved, domain-specific set of algorithms for organizing the domain of containers, it seems premature to rule out the possibility that Atran's results might be reconciled with the domain-general mechanisms that probably explain the formation of artifact cate-

gories. (For an excellent account of the relationship between naming and categorization in the biological domain, see Malt 1995.)

The case for exploring the role of domain-general mechanisms is actually further strengthened by Atran himself in the course of his excellent discussion of the many differences between the Maya and Michigan respondents in their treatment of the biological world (see sect. 2.0 ff.). Atran wants to view these as variations on the theme established by the core meme, but they could just as easily be explained without the need for this domain-specific notion if one makes a small number of simplifying assumptions about the context of operations for a domain-general concept learning system.

Assumption 1: The set of possible sortings, including sortings into domains themselves, is sharply restricted by the goals or purposes of the category learner. The importance of the concept learner's goals in establishing category structures is very nicely documented in work to which Atran has contributed (Medin et al. 1997). Attention to this fact about categorization helps to explain the differences between Maya and American respondents in Atran's work, as he himself notes. It also explains the observed differences between folk and scientific taxonomies as the result of the different purposes of the folk and the scientist, without denigration of either.

Assumption 2: The world is a structured place, with its own inherent patterns of similarity and difference, whatever the goals of the humans who encounter it. One need not assume natural kinds to take advantage of patterns of greater and lesser similarity in a set of entities. Indeed, this is an assumption that the advocate of domain-specificity must make in any event. Otherwise, there is no stable pattern onto which the process of phylogenetic "learning" or evolution can lock so as to establish the special-purpose algorithms for rapid tuning to the domain. The only dispute, then, is over the time course and mechanism of the adaptation to that structure. (Note that Atran's attempt [sect. 1.3] to address the question of differences between core memes and developing memes [the latter standing in for general purpose central processes] will remain unconvincing until the comparison is made for specific conceptual systems at comparable levels of abstraction from concrete observations, or until good experimental work supports the claim.)

Together, these two assumptions can account for the observed cross-cultural universals that constrain culture with respect to the biological world. First, the biological world is a lawful place and those laws themselves are discoverable by human (domain-general) concept learners, often in the form of the concepts themselves, without the need to represent the laws explicitly (cf. Millikan, in press). Second, further similarity across cultures results from the fact that at a certain level of abstraction, human goals constitute universals that condition the kinds of interactions we have with the biological world. Variations in the particular manifestation of those goals (of just the sort that Atran discusses when he contrasts the kinds of contact that Americans and Mayans have with their respective ecologies) and in the specific ecology (and therefore a pattern of similarities and differences) encountered, explain variations around the cross-cultural constants.

Other advantages of pursuing work on domain-general models include the fact that we are actually beginning to make progress toward an understanding of the mechanisms of concept learning (Edelman & Intrator 1997; Goldstone 1994; Livingston et al. 1998; Schyns et al. 1998), mechanisms that seem to operate for a variety of stimulus types. This is in striking contrast to the lack of information about what the algorithms might be for the domain-specific categorization system proposed by Atran. In fact, one clear way of strengthening the domain specificity case would be to identify the algorithms at work and then to vary the conditions of their operation in the laboratory in the same way that language researchers have done for phonemic and syntactic processes, or to test them in comprehensive simulations in the way that vision researchers have done.

Is there a knock-down case against conceptual domain speci-

ficity in the biological domain or in favor of domain generality? I do not think so. But neither is there a clear case against the generality thesis or for domain specificity. My own money is on the side of the generalists, but whatever the outcome of this debate, Atran's marshaling of the evidence in favor of specificity has certainly moved the discussion to a new level of sophistication, for which we can all be grateful.

## Domain-specificity in folk biology and color categorization: Modularity versus global process

Robert E. MacLaury

Department of Anthropology, University of Pennsylvania, Philadelphia, PA 19104. [maclaur@sas.upenn.edu](mailto:maclaur@sas.upenn.edu)

**Abstract:** Universal ranks in folk biological taxonomy probably apply to taxonomies of cultural artifacts. We cannot call folk biological cognition domain-specific and modular. Color categorization may manifest unique organization, which would result from known neurology and the nature of color as an attribute. But folk biology does not adduce equivalent evidence. A global process of increasing differentiation similarly affects folk taxonomy, color categorization, and other practices germane to Atran's anthropology of science; this is beclouded by claims of specificity and modularity.

Here are three objections to Atran's target article:

(1) "Generic" and "folk specific" are clearly defined and easy to use. Even if we were to adopt "generic species" (sect. 1.2), someone would propose yet another change.

(2) Universals of folk systematics are well attested. But why call them domain-specific and modular (sect. 1.2.2.3, para. 5)? Apparently, whenever language and cognition evolved, selection favored people who categorized flora and fauna most easily on the concrete and imageable level of biological species or, better, who thought of species in that manner – what anthropologists now call the folk generic rank. As it developed, this ability was probably applied with the same facility to concrete and imageable cultural artifacts, as it applies nowadays to coins, vehicles, clothing, architecture, weapons, tools, cooking utensils, electronic components, and so on ad infinitum. The makers of artifacts, now as before, might even accommodate their products to divisions comfortable to us at the generic rank, for example, penny, nickel, dime, and quarter as opposed to coin or money, or wheat penny, versus the current kind. Atran's "hierarchy without rank" is briefly argued and sparsely supported (sect. 1.1, para. 4), whereas his domain-specific modularity offers nothing more explanatory than "triggering algorithms for a living-kind module" (sect. 1.3, para. 4).

(3) Atran expresses an exceedingly crisp view of folk taxa, as though they were related only by contrast or inclusion (sect. 1, para. 2). I maintained an equally crisp anticipation of color categories when I went to the field with Munsell chips, but I found that, depending on the source of data, people named from 7% to 54% of their basic color categories with two terms of coextensive ranges. For example, one term might be focused in green and another in blue while each designated both hues (MacLaury 1997, p. 486). In folk biological semantics, my inference of coextensive naming is based on variation between individuals, where it has been called "naming confusion," "imperfect knowledge" (Berlin 1992: tables 2.3. and 5.2–3), or "covert category or complex" (Hays 1976: tables 7 and 9, pp. 503–4); Berlin et al. (1981, Figs. 3 and 4) diagram a grand example.

Coextension among folk generics is probably less substantiated than among color terms because (a) folk taxa are not measured with as exacting an instrument as 330 Munsell chips, and (b) most investigators of folk taxa neither look for coextension nor are even aware that it could obtain; or they minimize it. The notions of domain-specificity, modularity, and crisp categorial relations ad-

vance a preconception of folk biological classification that contradicts ethnographic fact, substitutes theory with mind-machine metaphor, and, if allowed to gain even more of a footing than it has already, may perpetuate "bias to model human cognition on scientific thought" (sect. 3.4, para. 3) and, worse, the bias in field work.

Because folk taxonomy and color categorization differ, the frequency of coextension, too, may differ between these domains. However, we find it as far afield as *cup* versus *mug* (Kempton 1978), *high* versus *tall* (Taylor 1992), *among* versus *between* (Gorbet 1995), *sex* versus *gender* (Gentile 1993), *motor* versus *engine* (Randall 1991), and even among medical terms, such as *patency* versus *reperfusion* (Dellborg et al. 1995). If folk biological taxa are not always crisp, they are hardly unique in this particular status (if they are unique in any capacity at all).

Folk biological taxonomy and color categorization differ as follows:

(1) Whereas the simplest type of the former consists of numerous named folk generics, the simplest color categorization consists of light versus dark, bright versus dull, or light-warm versus dark-cool (MacLaury 1997, Fig. 13).

(2) Whereas folk biological taxonomy adds substantial complexity by naming ranks higher and lower than the generic one, color categorization evolves in the main by partitioning the color domain with progressively more basic categories (MacLaury 1992, Fig. 19).

(3) The basic categories of folk biology are largely of the generic rank and correspond to scientific species, whereas basic color categories are only those named commonly and saliently, and not as hyponyms (MacLaury 1991, Fig. 4).

(4) Whereas folk generic categories can number in the hundreds, the maximum number of basic color categories is 11 – notwithstanding the Russian blues (Taylor et al. 1997) or Hungarian reds (MacLaury et al. 1997).

(5) Whereas a folk taxonomy may show a maximum of six ranks – kingdom, life form, intermediate, generic, folk specific, and folk varietal – color categories seldom exceed two levels between which a basic hyperonym directly includes one or more nonbasic hyponyms, with the apparent record of four levels in Navenchauc Tzotzil (MacLaury 1991, Fig. 9).

(6) A single folk taxon or a few taxa may change rank, whereas the basic level of color categorization moves from the initial bipartite partition to the eleven divisions while change pervades the entire system (MacLaury 1991, sect. 6.1).

Although the characteristics of folk taxonomy may also apply to hierarchical classifications of artifacts, color categories seem to show domain-specific properties. If so, most of them may derive from the nature of color as an attribute and from its perceptual structure of six pure points, the different perceived distances between these points, and continua of brightness and saturation. Unlike folk taxa, color categories are not ascribed to referents for their morphologies and behaviors, but result from physiological translation of wavelength and from selective emphases on similarity and difference among the received signals.

This account – problematic though it is – may be as close as we can come to describing specificity in any domain or to identifying a cognitive semantic module. The known physiology and cognitive processes of color categorization may resemble Atran's "dedicated perceptual-input-analyzer that attends to a restricted range of information" (sect. 1.3, para. 4), as far as I can interpret the phrase. Yet the precision of knowledge about color might dampen our hope to isolate "mechanisms" of equivalent specificity for exclusively folk biology (sect. 1.2.2.3). Where would we even look for them? Should we monitor the rain activity of human subjects for a unique response to seeing plants and animals? Would such activity register differently from the response to seeing artifacts?

The progressive division of the spectrum is driven by increasing emphasis on difference (MacLaury 1997, Fig. 7.18), and more than simple societies, complex societies routinely require the constant and generalized application of such emphasis. Thus, English

and Spanish name more and narrower basic color categories than do the Mayan languages visited by the Mesoamerican Color Survey (Itzaj was not surveyed, although its close relative, Lacandon, was found to name five color categories, including the “cool” category covering green and blue, as does its more distant relative, Tzeltal [MacLaury 1997, Figs. 4.3–10 and 11.14]). Yet Itzaj and Tzeltal name numerous trees as folk biological generics and presumably subdivide some tree generics into folk specifics, whereas even the folk generic tree names of many English speaking Americans have become empty lexemes. Atran nevertheless finds that such English speakers draw inferences between these folk generics and folk specifics – that is, their nameless biological equivalents – as readily as do Itzaj speakers. I will accordingly change roles with Atran here, and will likewise speculate: I would guess that the Itzaj demonstrate this acuity because they sustain interest in folk biology particularly, whereas the English speakers show similar acuity because of pressure from the demanding society in which we live to sustain analytical thought during any task, whether it be color naming or folk biological inference. (Perhaps this is why Americans, more than Itzaj, reason from taxonomic diversity, i.e., goats and mice share a disease because both are mammals rather than because both could be bitten by bats [sect. 2.1.2.3]). Thus, rather than having folk taxa constitute an inherent module, Itzaj and Americans each single out the taxa for a different motive.

To continue this speculation, I will imagine myself sorting pictures of nineteenth-century sailing ships after being asked: “Which of these ships have the same design flaw as this ship pictured here.” Unwittingly, I pick all the schooners, passing over the sloops, yawls, and frigates, not even having a clue about how to use such names. I merely rely on the way I habitually analyze every novel situation I encounter during a normal (hectic) week, and although I cannot be certain (and might be ethnocentric) – I suspect I would sort the ships more accurately than equally uninformed Itzaj speakers, who, I suppose, would be less accustomed to systematically breaking down novelty. But I know we could say a bit more about ships than do the Itzaj. To falsify this hypothesis of unequal analytical emphases, Itzaj and Americans must draw inferences from taxa totally foreign to both.

Increasing the routine emphasis on difference may account for far more than color term evolution. According to this view, I find Atran’s anthropology of science extremely promising, as I do his distinction between a folk biological taxonomy based on direct involvement and judgment of overt similarity versus scientific biological systematics based on an overview of nonobvious phylogeny. An epochal shift toward an analytical perspective has ensued from increasing differentiation over the millennia as a general adaptive strategy, of which stages of color naming and conscious rethinking of biological taxonomy represent only two manifestations. Both accompany other elaborations of language (Malkiel 1941), stages in the development of writing systems (Olson 1994), supplementation of local geographical knowledge with global cartography (Clark 1992), and the rationalization of skills, trades, and technologies, including the emergence of science. Many of these outcomes involve detachment of perspective as well as enhanced analysis (MacLaury 1997, sect. 9). Old and new thought may co-exist in such realms because the two serve separate perspectives, with the old system surely in closer keeping with the way human cognition evolved. But the persistence of a particular cognitive organization in biological reasoning does not mean that folk taxonomic thought is specific only to this domain or that the domain is modular.

## Atran’s evolutionary psychology: “Say it ain’t just-so, Joe”

James Maffie

Department of Philosophy, Colorado State University, Ft. Collins, CO 80523-1781. maffiej@spot.colorado.edu

**Abstract:** Atran advances three theses: our folk-biological taxonomy is (1) universal, (2) innate, and (3) the product of natural selection. I argue that Atran offers insufficient support for theses (2) and (3) and that his evolutionary psychology thus amounts to nothing more than a just-so story.

Atran advances three theses: our folk-biological taxonomy is (1) universal, (2) innate, and (3) the product of natural selection. Thesis (1) is fine, but there are problems with theses (2) and (3).

First, why think our folk-biological taxonomy is innate rather than acquired? Universality certainly suggests innateness but it is inconclusive; it may be the result of universally shared, domain-general capabilities interacting with a shared, universally structured environment. Atran cites two kinds of support for innateness: recent experimental findings and an inference to the best explanation invoking natural selection.

Let us suppose that there is enough environmental structure – that is, “recurrent habits of the world” such as immediately perceptible features of behavior and morphology as well as ecologically salient types of life forms – to serve as an independent selective force favoring the domain-specific, folk-biological taxonomy Atran describes. If this is so, then there is also enough environmental structure for people in all cultures to generate this taxonomy empirically without the need for a domain-specific innate structure. The same environmental pressures Atran cites as favoring the natural selection of his innate taxonomy also favor its empirical generalization: obtaining food, surviving predators, avoiding toxins, cooperative subsistence behavior, and so on. If, on the other hand, there is not enough environmental structure for humans to generate this taxonomy empirically, then neither is there not enough environmental structure to evolve the taxonomy. Either way, Atran’s inference from universality to innateness by way of natural selection does not succeed.

Atran’s experimental studies of “ecologically experienced” Lowland Mayans and “ecologically inexperienced” American students do not answer this criticism because they are inconclusive. Although they lack direct individual ecological experience Atran’s American subjects have been immersed from birth in a folk taxonomy rooted in their culture’s ecological experience. Where this folk taxonomy comes from is precisely the question at issue, so it cannot be answered by these experiments. They may have acquired the information from bedtime stories, picture books, cartoons, nature films, summer camping trips, excursions into their own back yards, parks or zoos, or from the natural-kind terms embedded in their native language. No industrialized child is folk biologically acultural. Does the spontaneous character of this taxonomy suggest that it is innate? Perhaps, but Atran’s remarks about this are not too helpful.

Finally, Atran’s attempt to explain innateness through natural selection amounts (as stated in Lewontin 1990, p. 229) to “nothing more than a mixture of speculation and inventive stories.” After all, there are many ways a trait may become fixed other than being directly selected for: chance, drift, hitchhiking, pleiotropy. Furthermore, a trait may even improve fitness without having been selected for as an adaptation. A successful selectionist explanation requires ample empirical evidence that environmental selective forces – rather than internal-structural ones such as drift or hitchhiking – play a significant role in and thus provide the best explanation of the fixation of the trait (see Maffie 1997). But as Lewontin (1990) and Richardson (1996) argue, this requires specific and detailed historical information about (1) the kind and degree of variation present in our ancestors and our ancestral environment, (2) the actual environmental pressures affecting survival and reproduction, and (3) the demographic factors (e.g., gene flow

and population structure) at the time. For example, were generic-species, folk-kingdom, folk-specific, and domain-general taxonomies all fixed at one time in our hominid ancestors? What concrete evidence do we have for thinking that those ancestors who had the generic-species taxonomy actually left more offspring than those that had the others? Moreover, because all folk taxonomies diverge from the objective structure that we learn from biological science alternative folk taxonomies would all be more or less equally useful (in terms of obtaining food, surviving predators, etc.) and hence roughly equivalent, selectively leaving insufficient selective pressure to favor any one of them. Atran must address such issues before inferring that selection *for* – rather than mere selection *of* – our folk taxonomy has taken place (see Sober 1993).

In conclusion, although humans and their cognitive faculties are undoubtedly the product of a long history of evolution, nothing Atran says supports his inference that our folk-biological taxonomy is an innate evolutionary adaptation. General remarks about “habits of the world,” acquiring food, and surviving predators are vacuous as an explanation. Atran’s evolutionary psychology amounts to nothing more than a just-so story.

## Relations between innate endowments, cognitive development, domain specificity, and a taxonomy-creator

Adee Matan and Sidney Strauss

Unit of Human Development and Education, School of Education, Tel Aviv University, Tel Aviv 69978 Israel. [adee@ccsg.tau.ac.il](mailto:adee@ccsg.tau.ac.il); [sidst@ccsg.tau.ac.il](mailto:sidst@ccsg.tau.ac.il)

**Abstract:** Atran proposes that humans have a unique, innate, domain-specific tendency to create taxonomies of biological kinds. We show that: (1) in ontogenesis, children develop a notion Atran claims to be innate; (2) what Atran claims is unique to biological kinds may be found in artifact kinds; and (3) although Atran proposes a domain-specific mental construct for biological rank, it can be explained in domain-general terms.

In his intriguing target article, Atran addresses fundamental aspects of human cognition: innate endowments and domain specificity. We discuss each in light of his claims about a unique, domain-specific biological taxonomy.

**Innate endowments.** Atran proposes that the ability to create a biological taxonomy is the result of an innate, domain-specific endowment, just as human knowledge about physics, psychology, and language have been claimed to originate in innate, domain-specific endowments. According to Atran, this taxonomy is created by a living kind module that does the work of partitioning the world into essence-based generic species and taxonomic groups. The argument for the innateness of the living kind module stems from the claim of universality. In the case before us, Atran found the same biological taxonomy, with the same preference for the taxonomic rank of generic species across two cultures as different as Midwestern Americans and the Itzaj Maya. Given the distinct physical and cultural settings in which these human groups find themselves, and that domain-general models of similarity cannot explain these findings, Atran argues that the living kind module that creates his taxonomy is innate.

We speak to the relations that inhere between innateness and development. Our claim is that Atran has not taken into account the findings that the concept of living kind has been shown to follow a developmental trajectory sometime in mid-childhood (Carey 1985). For example, 4- to 7-year-old children judge animals (e.g., dogs) and plants (e.g., flowers) to be alive, but they also judge some artifacts (e.g., cars) to be alive. And children who rightly claim that artifacts are not alive, may also wrongly claim that plants are not alive.

Thus, even though there is evidence that preschool children can distinguish between animals and nonanimals and that they may

understand that there are certain properties, for example growth (Backschieder et al. 1993), that plants have and artifacts do not, it is not until late in development that these facts become related to the concept “alive” and that young children combine plants and animals into the ontological category of living thing. We believe that if Atran is basing the biological taxonomy on a living kind module, he should give an account of the relations between the proposed innate tendency to build taxonomies of living kinds and the developmental course of the understanding of living kinds in ontogenesis.

**Domain specificity.** Atran claims that this biological taxonomy issues from a cognitive structure unique to the domain of biology. According to Atran, two signs indicate its uniqueness and domain specificity: (1) the entities of this taxonomy, namely, biological entities, have deep underlying essences and (2) the notion of rank is unique to the biological kinds taxonomy.

**Essences.** Atran suggests that biological essentialism is a unique type of essentialism, thus providing evidence for the uniqueness of the structure he has found. The argument is that biological kinds have a deep underlying essence, whereas the members of other known taxonomies such as nonbiological natural kinds (e.g., gold) and artifacts (e.g., chairs) do not have deep underlying essences because these entities are not the outcome of an “imperceptible causal complex.” (sect. 1.2.1). It may indeed be the case that when applied to different types of entities, the notion of essence can have different manifestations. Nevertheless, the properties and existence of nonbiological natural kinds (Schwartz 1979) and artifacts (Bloom 1996) are determined by an underlying causal mechanism, an essence.

Let us examine this claim for the more controversial case of artifacts. Bloom (1996) argues convincingly that the essence of artifacts, or in Atran’s terms, the imperceptible causal mechanism that accounts for their properties and existence, is the fact that they were successfully created with the intention of belonging to a certain category kind: What makes a chair a chair is the fact that it was intentionally created (intentions being imperceptible) to belong to the category chair. Empirical research coincides with Bloom’s claims showing that for both adults (Hall 1996) and young children (Matan 1996), the original intended design of an artifact (as opposed to a current intended function) determines artifact-kind judgments. Thus, having an imperceptible causal mechanism to account for properties of entities and determine category identity is unique neither to biological kinds nor to the universal biological taxonomy that Atran finds.

**Rank.** Atran claims that rank is unique to biological taxonomies and is not to be found in other hierarchies. Although he does not say so explicitly, Atran seems to suggest that we must also be innately endowed with a unique, domain-specific rank-maker, otherwise we would be hard put to explain how our cognitive system produces rank in biological kind taxonomies.

From the fact that biological taxonomies have unique properties it does not necessarily follow that a biological taxonomy that includes rank is the result of a unique, domain-specific construct. It is no less plausible that humans have an innate, domain-general, disposition to create taxonomies, which would explain why our cognitive system creates taxonomies of artifacts, living kinds, and so forth. It is possible that rank is an emergent property that results when a domain-general taxonomy-maker is applied to the creation of a taxonomy of biological entities. Thus, even though a biological taxonomy may have unique properties, the ability to build taxonomies may be a domain-general one.

Our comments about ontogenesis, the ubiquity of essence, and a possible human predisposition to create taxonomies notwithstanding, we believe Atran has made an important contribution to the understanding of the generic species as a preferred taxonomic rank.

## What is rank?

Adam Morton

Department of Philosophy, University of Bristol, Bristol BS8 1TB, United Kingdom. [adam.morton@bristol.ac.uk](mailto:adam.morton@bristol.ac.uk) [mail.bristol.ac.uk/~plam](mailto:mail.bristol.ac.uk/~plam)

**Abstract:** The concept of rank is not a very clear one. Claims that two concepts occupy the same rank in different domains are in danger of being unintelligible. Examples show how hard it is to understand Atran's claim that the most significant concepts in folk biology occur at a higher level than nonbiological concepts. A reformulation preserves some of what Atran wants to claim.

This is an exercise in clarification rather than criticism. One central claim in Atran's target article is that in the biological domain human cognition takes the form of a system of concepts organised in terms of the interesting and problematic factor of *rank*. The most significant biological concepts are those at the rank of generic species. Call this the *rank claim*. The rank claim is augmented with the *asymmetry claim* that the most cognitively significant of our concepts in other domains are more specific than the most significant biological concepts, being analogous to the level of the folk-specific. These claims are only as intelligible as the idea of rank and the idea that the structure of concepts in one domain can be compared to the rank structure of another. Thus, Atran would claim that of *toy poodle*, *poodle*, and *dog* the generic species concept *dog* plays the largest cognitive role, whereas of *rocking chair*, *chair*, and *furniture* the concept *chair* plays a role of corresponding significance. Suppose that these claims about the importance of *dog* and *chair* are right. Does this show that concepts of different ranks play similar roles when talking about mammals and when talking about house furnishings? Not necessarily, for we can structure the latter domain in terms of *platform rocking chair/rocking chair/chair/furniture*, and in this hierarchy *chair* occupies the same position as *dog* in the former domain. And of course we can reorganise the former domain into *albino toy poodle/toy poodle/poodle/dog*, restoring the asymmetry. Parallels can be made to appear and disappear at will by drawing different correspondences between the two hierarchies.

Now, Atran denies that there is a rank structure to the domain of household furnishings. This preserves the rank conclusion while leaving the asymmetry conclusion in danger of being unintelligible. A natural and more careful reformulation of the asymmetry claim might be: Only in concepts of the biological realm is there a rank structure, and in it the most significant concepts occur at the level of generic species. This level is higher in the structure than that of the folk-specific or the folk-varietal; nevertheless it is the cognitively the most significant one, in contrast to non-biological domains where the most significant concepts occur at the level of concepts that are lower in the (nonrank) hierarchy of concepts. But there are problems with this formulation, too. Why are generic species concepts not analogous to concepts like *chair*? Both form part of a system of mutually exclusive concepts that largely cover their domain. And both satisfy the conditions for a psychologically preferred taxonomic level as described in section 1.2.2.

I have a strong intuition that there is something true about what Atran is saying here, if rightly construed, but it is not easy to find the right construal. The idea of rank is central to the claim. But how do we determine the rank of a concept? *Tree* and *fish* are at generic species rank, in contrast to the alternatives *maple* and *trout*. So which of *toy poodle*, *poodle*, *dog*, *mammal*, *vertebrate*, or *animal* is at the generic species rank? Intuitively, *dog*. But *dog* seems to be at the rank of *trout* rather than *fish*, both in terms of scientific biology and in terms of folk classification. To see this note that below *fish* we have two levels, containing *trout* and *speckled trout*, consisting of concepts for which we have simple and frequently used words that can function as semantic units; and analogously, below *mammal* we have two levels – *dog* and *poodle*. There is the concept of *toy poodle*, but then there is also the concept of *northern speckled trout*. Without a stable bottom to the structure parallels can be drawn at will.

If there is an innate tendency to structure animal concepts in a given way, then it is initially plausible, and Atran's evidence makes it more probable, that this structure consists of a hierarchy of concepts such that at each level a set of nonoverlapping concepts exhausts the extension of the next higher concept. Atran wants to go beyond this to claim cognitive significance for relations between concepts dominated by different and more general concepts. Even within the biological domain this is a puzzling idea. Which of *flower[ing plant]* and *rose* is at the same rank as *fish*, which of *dormouse*, *mouse*, and *rodent*? It seems inevitable that the answers relevant to cognitive psychology rather than to biology will depend on the beliefs and practices of the people concerned. This conclusion invites three reformulations: (a) all people will impose on biological concepts a tree-structured taxonomy in which on any branch there is exactly one concept of greatest cognitive significance; (b) the most significant concepts on different branches will have roughly the same number of concepts dominating and being dominated by them; and (c) the most significant nonbiological concept will tend to dominate fewer concepts than will the most significant biological concepts.

### ACKNOWLEDGMENT

Thanks to Alex Barber for helpful discussion.

## A comparative and developmental approach to cognitive universals: A possible role for heterochrony

Warren P. Roberts

Department of Anthropology, University of Georgia, Athens, GA 30602. [wrobertsjr@juno.com](mailto:wrobertsjr@juno.com)

**Abstract:** From a developmental and comparative perspective, folk biology is a core "meme." The universality and resistance to change in such core "memes" may be a function of the developmental timing of cognitive domains during childhood. Evidence from cognitive development in humans, monkeys, and apes is discussed. Suggestions for a developmental research program are offered.

Atran has provided a provocative account of the nature and evolution of biological categorization, raising important conceptual and methodological issues for cognitive anthropologists and evolutionary psychologists. This is a potentially rich area for cognitive anthropology. This commentary addresses Atran's model of human cognitive evolution from a comparative and developmental perspective.

A recent hominid origin for cognitive domains is fundamental to evolutionary psychology (Barkow et al. 1992). Atran follows this line of thought, suggesting that natural categorization, or folk biology, is of hominid origin (sect. 1.2.1, para. 1; sect. 1.3, para. 13). Experiments with numerous species suggest, however, that the capacity to form natural categories is far more ancient and widespread phylogenetically (for review see Vaclair 1996). A striking example of such categorization is the ability of pigeons to construct a natural category for fish (Herrnstein & de Villiers 1980). Complex animals must be able to "see as significant" features of the living world (Neisser 1993; Popper 1984), and to form relationships based on perceptually conceived regularities (Cerella 1979). This should promote caution in attributing a special role for this ability to any one animal group, such as hominids.

Evidence for a widely distributed (if variable) zoological capacity to recognize natural categories requires a refinement of Atran's core and developing memes model (sect. 1.3). Categorizations of natural kinds in animals are private events [see Lubinsky & Thompson: "Species and Individual Differences in Communication Based on Private States" *BBS* 16(4) 1993] (rather than memes), which form the evolutionary basis of core memes. According to Atran, "core memes" may be shared by simple acts such

as pointing (sect. 1.3, para. 15). Pointing is documented only for humans and captive great apes (Krause & Fouts 1997; Leavens & Hopkins, in press; Miles 1990). The cognitive foundation for both natural category formation and Atran's minimal conditions for eliciting shared core knowledge are present in some apes. If the potential for core memes has been present since the advent of "ape grade" intelligence, why the delay in the evolution of developing memes?

Comparative work in cognitive evolution has indicated that a major difference between monkeys, apes, and humans lies in the developmental timing of cognitive domains related to classification (Langer 1996). In Langer's model, recursion (self referential information flows which monitor changes in the condition of cognitive systems) within and integration between domains enables higher order forms of cognition to develop. His research indicates that recursion is not possible in monkeys because the development of domains is nonoverlapping. For example, the development of physical cognition is completed prior to the onset of the development of the logico-mathematical underpinnings of complex classification. Langer found no second-order cognition in monkeys. In chimpanzees, logico-mathematical cognition emerged just before the end of the development of physical cognition. Chimpanzees exhibited some second-order cognition, although later than humans. For humans, the two systems emerged and developed concurrently, with second-order physical and logico-mathematical cognition emerging simultaneously. These differences are reflective of heterochrony (evolution by change in ontogenetic timing) in human cognitive development.

Atran states that folk systems capture memorable, attention-grabbing phenomena (sect. 1.3, para. 20), that suggest there are cognitive and motivational commitments to apprehending these phenomena. He also says that such systems are highly resistant to change, requiring a high degree of institutional influence (Conclusion, para. 5). This may be a function of developmental timing. Basic systems supporting core memes may emerge early in ontogeny and be largely developed prior to the emergence of high degrees of recursion and metacognition. These systems may have to be effortfully overridden from higher, more recent levels, in particular, social informational environments. Atran's suggestion that we explore cultural transmission (sect. 1.3, para. 23) should include ontogenetic research. This will require nonlinguistic procedures such as sorting tasks and match-to-sample paradigms using gaze duration and other age-appropriate measures.

The developmental trends in modern humans are very different from those of apes and early hominids. Even recent archaic *Homo* followed developmental patterns unlike those seen in modern populations (Stringer & Gamble 1993). Understanding the evolution of and relationship between core and developing memes will require understanding the modern, developing human mind in relation to its social and informational context.

### Measuring cognitive universals and cultural particulars

A. Kimball Romney

Department of Anthropology, University of California, Irvine, Irvine, CA 92697-5100. akromney@uci.edu  
[www.socsci.uci.edu/mbs/personnel/romney/romney.html](http://www.socsci.uci.edu/mbs/personnel/romney/romney.html)

**Abstract:** A reanalysis of Atran's data is presented in which the comparison between Itzaj and Michigan animal names is represented in spatial rather than taxonomic form. Similarity among all subjects is also represented in spatial terms. Finally, culturally shared knowledge between the two cultures is shown to be about ten times larger than the culture-specific component unique to each culture.

Atran's work relates to the protracted debate on the issue of cultural universals versus cultural relativity involving a variety of se-

mantic domains, for example, the Berlin and Kay (1969) work on color recently debated in this journal (Kay & Berlin 1997; Saunders & van Brakel 1997), Ekman and colleagues' research on the universality of the linkage of emotions and facial expressions (Ekman 1992; Ekman & Friesen 1975), Herrmann and Raybeck's (1981) cross-cultural comparison of animal and emotion terms in six languages, and the Romney et al. (1997) work on English and Japanese emotion terms. It is also important to note that the semantic domain of animals has appeared as one of the most frequently used domains in psychological studies and that spatial representations are known to relate to a number of cognitive functions (see citations in Romney et al. 1995).

The main purpose of this commentary is to present an independent analysis of Atran's Itzaj and Michigan mammal data, as discussed in sections 2.1.1. and 2.1.2. of the target article. Atran kindly provides the raw data from which he has derived the tree diagrams depicted in his Figures 3 and 4. Individual mammal taxonomies were obtained for 8 Itzaj subjects (4 subjects with missing data were eliminated) and 12 Michigan subjects. Each individual taxonomy contained 16 animals (excluding "bat") shared by the two cultures. The results of our reanalysis reinforce the main findings of Atran and provide additional insight concerning the amount of variability between and within cultures.

Figure 1 shows the results of a joint multidimensional scaling (MDS) implemented with correspondence analysis (Romney et al. 1997) of the mean values from each culture. The scaling results in three clear-cut subgroups of animals in both cultures with substantial agreement in the classification. The picture does not provide good resolution of animals within each subgroup, possibly resulting from methods of data collection, the manner of sampling animals for comparison, and so forth.

By treating the taxonomic judgments of each individual as a vector we obtained a single correlation matrix for subjects from both cultures. Figure 2 shows a plot comparing all subjects on the second and third dimension of a singular value decomposition of the correlation matrix. In this representation the subjects who are more similar in their taxonomies are closer to each other than the subjects who are less similar. Except for the outlier Michigan subject in the Itzaj area (for which we have no information), there is a dramatic and clearcut difference in the pattern of responses of the two groups.

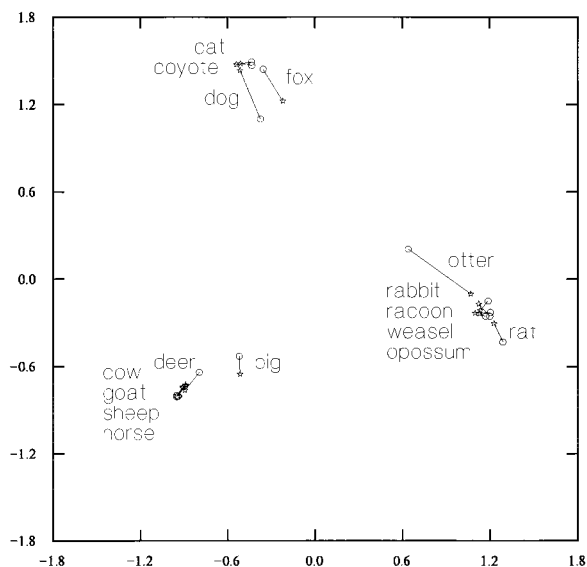

Figure 1 (Romney). A spatial representation of the relative placement of animals for Itzaj (circles) and Michigan (stars) subjects.



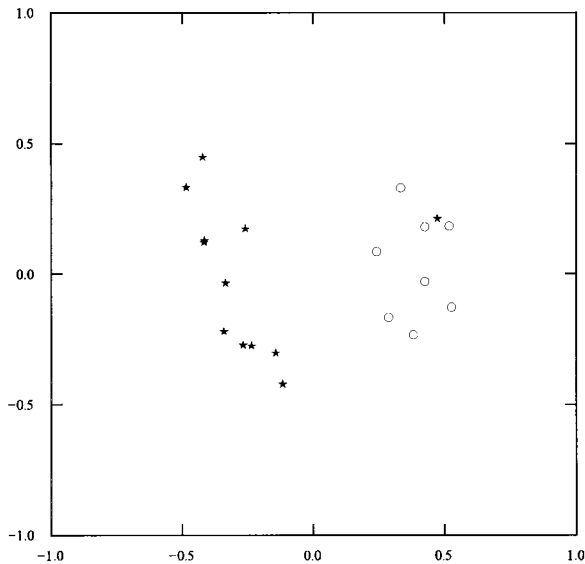

Figure 2 (Romney). A spatial representation of the relative similarity among Itzaj (circles) and Michigan (stars) subjects.

Whereas Figure 1 gives the impression of substantial agreement between groups, Figure 2 gives the impression of substantial differences between groups. How can we best measure and compare the extent to which the groups are similar and different? We propose an extension of the consensus model (Romney et al. 1996; 1997) as a general solution to problems of this kind. The question can be answered by measuring how much of any subject's knowledge is (1) held in common with all subjects regardless of culture, (2) specific to their own culture, or (3) unique to the individual or a result of sampling variability and measurement error. Culture consensus theory consists of a family of formally derived mathematical models that simultaneously provide an estimate of the cultural competence of knowledge of each subject and an estimate of the correct answer to each question asked (Batchelder & Romney 1988; Romney et al. 1988).

For the Atran data we make some simplifying assumptions and apply an informal data-level model. The two major simplifying assumptions are that Atran's sorting task produces interval level data and that the answer key for the task is the simple mean of the subject's responses ("taxonomic distances" for each pair of animals). In the standard consensus model the answer key is weighted by each individual's competence, but with a reasonable number of subjects the unweighted mean rapidly converges toward a reasonable estimate. With these assumptions we can easily estimate mean competence of subjects based on an answer key common to both culture versus an answer key specific to each culture separately.

The mean cultural knowledge estimated from a single answer key derived from all 20 subjects is .69. This represents the knowledge common to both Itzaj and Michigan subjects. The mean cultural knowledge estimated for the 8 Itzaj subjects is .79; the mean cultural knowledge estimated for the 12 Michigan subjects is .75. The mean knowledge of the two groups, each compared to their own answer key, is .76. On average, therefore, the culture-specific knowledge adds about .07 to the knowledge held in common by the two groups. The remaining .24 would include individual differences (estimated as .09 on the basis of multiple tasks for the domain of emotions in Romney et al. 1997) and residual sampling and error variance. Figure 3 illustrates the comparison in visual form for ease of comprehension.

The general methodological approach that produced Figure 3 should be widely applicable to psychological research that compares similarities and differences among groups. It is interesting

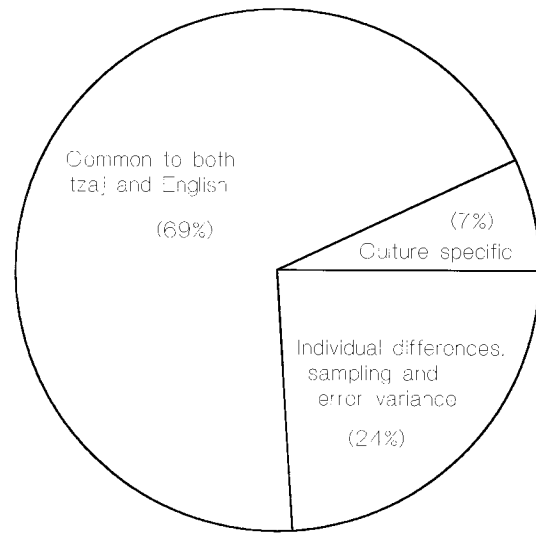

Figure 3 (Romney). A plot of the relative contribution to knowledge of common, culture-specific, and residual components of culture.

to note that the similarities and differences between cultures on the abstract domain of emotion terms in English and Japanese (Romney et al. 1997) is almost identical to the concrete domain of animal terms in Atran's research.

### What is empirical about Atran's taxonomies?

Barbara Saunders

Higher Institute of Philosophy, University of Leuven, 3000 Leuven, Belgium; and Department of Anthropology, University of Leuven, 3000 Leuven, Belgium. [pop00127@mail.cc.kuleuven.ac.be](mailto:pop00127@mail.cc.kuleuven.ac.be)

**Abstract:** Atran reifies Fodor's metaphor of modularity to create a truth-producing apparatus to generate a priori taxonomies or natural kinds that lock a tautology in place.

It is misleading to regard Atran's anthropology of science as a representative illustration of either science or anthropology in general. Rather, it illustrates cognitive anthropology's commitment to modules, memes, and biocultural explanations. Although the relation is not as well worked out, it is also located in the historical conjuncture of cognitive science and neo-Darwinism. But to fit more neatly into this programme, a stage-model of development, as distinct from hand-waving toward the evolution and adaptation "of our ancestors" is needed.

My problem with Atran's target article is that it is question begging. Although it sets out to show empirically that in every human society people think about plants and animals in the same special way, Atran takes this as his a priori premise from the outset. This is one of the disguised ways of talking about "universals," usually deriving from Aristotelian or Kantian categories without which (so the argument goes) we could not think at all. Another example of this "pseudo-empirical" (Smedslund 1991a; 1991b) strategy is Berlin and Kay's Basic Color Terms (1969; 1997; cf. Saunders & van Brakel 1997).

In Atran's case, the etiolated basis of comparison comprises so-called pan-human "domain-specific cognitive processes," which involve patently "clear and distinct" partitions, and partitions of partitions. According to this way of looking at things it is not surprising that other domain-specific cognitive processes map quite nearly onto the partitions (for example, "language" or "expecta-

tions”). As Nature carves the joints (partitions world and cognitive domains) it is reasonable to expect concordance between them, this being the cunningness of Nature. There are inevitably wrong or mistaken hits and misfirings (outliers), but these merely reinforce the beauty of the system. To glue this picture together, some philosophy (Davidson’s 1984b transcendental argument about “charity”) is also brought to bear.

Sometimes, clarification is helped by going back to origins. Although modules are taken to be domain-specific, innately specified, hard-wired, autonomous, and mandatory, what Fodor (1983) actually says suggests that less hubris is in order. [See also BBS multiple book review of Fodor’s *Modularity of Mind* BBS 8(1) 1985.] He is at pains to point out (1983, p. 37) that “modularity” is a theoretical notion. To view the cognitive system as “modular” is always to do so “to some interesting extent” (Fodor’s *ceteris paribus* loophole), and “the most important aspect of modularity . . . [informational encapsulation] . . . has yet to appear.” Now Atran might think that his data have added to the pile of Progress, but he has not shown empirically, nor will he ever be able to show, that a living thing/being module is informationally encapsulated. Why? Because as Fodor shows, modules are a “theory.” They have no “structure,” not in the ephemera of “cognition” nor in the structures, functions, and processes of the brain.

What Atran has done is take Fodor’s metaphor (which is none other than updated eighteenth century faculty psychology) and hypostasize it, and add a mass of taxonomy arrived at by a highly sophisticated technology of data gathering and analysis. Now if Atran’s message is that to have taxonomies, there have to be domain-specific modules, then that is an a priori proposition. It relies on modules defined as non-contingent and necessarily true. Their plausibility stems from the conceptual relatedness of the variables involved (e.g., domain-specific taxonomies), not from actual data. As the truth value of “module” relies on analyses of domain-specific taxonomies in the first place, a tautology is locked in place.

The sophistication of the data gathering (itself the product of various theories) is matched only by the very low level of conceptual analysis. Nonetheless, once in place, this edifice cannot be called to question by contrary observations. This is because the recursive feed back effects between taxonomists’ networks of theories, models, data, and apparatus “mesh” to give a snug “fit” with decontextualised taxonomic reality. This “fit,” however, is the result of whatever is admitted from the world-out-there being tailored to fit the taxonomic reality. To make “living kinds” the phenomenon is to define those kinds in a particular way, under a particular description, by removing from the experimental setting anything but their own purified realisation. Relegating “context” to the periphery, the phenomenon so defined by a contextless procedure is placed at the core. Standing behind to ratify the procedures are domain-specific modules. These help produce objectivised data by creating the phenomenon in isolation, which can then be appropriately framed at different levels within networks of different levels of theory. This is the truth-producing apparatus that generates the taxonomies or natural kinds that Atran discusses. I can see no way in which an empirical study in the future will be able to dislodge, let alone disprove, Atran’s model.

## Innateness, universality, and domain-specificity

Gregg E. A. Solomon

Department of Brain and Cognitive Sciences, Massachusetts Institute of Technology, Cambridge, MA 02139. [geas@psyche.mit.edu](mailto:geas@psyche.mit.edu)

**Abstract:** There are problems with Atran’s argument for an innate cognitive module for folk biology. He has been too quick to assume innate origins for what might plausibly be learned. Furthermore, in his characterization he includes aspects – essentialist reasoning and inductions from classes – that are not domain-specific. Finally, his characterization compromises his argument that the module is pretheoretical.

Much as I admire Atran’s demonstration of cross-cultural universals in adult folk biologies, and although I believe that the acquisition of some folk theories has innate, domain-specific support, I believe that Atran assumes innate origins for adult universals too readily, and includes in his characterization of the module aspects that are neither domain-specific nor pretheoretical. We should be conservative in making nativist attributions. Even nativist claims about language – the paradigm example of domain-specificity and adult universality – are not proposed as deductive arguments. Neither a nativist nor an empiricist position is preferable by default. The point is that a strong nativist account of the acquisition of adult universals ought to be accepted only when no plausible domain-general learning mechanism can be imagined or when none that can be imagined is explanatorily adequate. Plausible accounts of the acquisition of folk biology that focus more on domain-general learning processes can be imagined, and determining whether they are adequate remains, in part, an empirical enterprise.

Let us look first at Atran’s characterizations of the innate cognitive module: it includes aspects that are not unique to the domain. First, there is nothing uniquely folk biological about the fact that systems of classification support induction. That is a function of categories in general. Second, psychological essentialism describes how people reason about natural kinds, such as gold. Our inferring that animals and plants have essential natures says nothing, in and of itself, about a uniquely folk-biological mode of reasoning.

Rather than reduce his claims about the innate module to claims about folk taxonomy, Atran argues that there is a uniquely biological essentialism. But insofar as an essence is a placeholder for causal principles, understanding different kinds of essentialism means understanding different kinds of underlying causal principles. The problem is that in making this claim Atran compromises his argument that folk biology is pretheoretical, for understanding causal principles is a hallmark of later theoretical reasoning.

Moreover, by describing biological essentialism as teleological, Atran again refers to a mode of reasoning that is not unique to biology. It is also an attribute of psychological reasoning and of reasoning about artifacts. It is likely that children do come to understand that there is a uniquely biological teleology or vitalism organized, for example, around the goal of the maintenance of life (Hatano & Inagaki 1994). But that in no way demonstrates that earlier teleological reasoning itself is biological. A distinctly biological teleology or essentialism (as opposed to a more garden-variety construal) could be learned, and there is nothing yet to indicate that it is not.

Where does that leave us? Atran may well have found a set of innately supported constraints bearing on the construction of folk taxonomy. I agree that we may be predisposed to assign more weight to some features (such as animate motion or heterogeneous structure) than to others in making classification judgments. Constellations of morphological and behavioral features could determine the construction of a privileged taxonomic rank. Of course, from the fact that the generic species level is inductively privileged for adults it does not follow that it must be develop-

mentally privileged. For example, children might first be disposed to distinguishing life forms. It is the level at which perceptual similarity is maximized for midwestern adults and it corresponds to the basic level of Rosch et al. (1976). Atran deserved credit for pointing out that it is at the generic species level that the induction of biological information is maximized, but is it maximized for very young children? And what do they consider to be biological information? Atran's induction studies were conducted with adults and involved inferences about disease, a phenomenon understood only incompletely by children (Solomon & Cassimat 1996). Might it be that it is only after children understand biological principles that they come to expect that relevant biological information will maximally covary by generic species? These are empirical questions.

In any case, even given an initial set of classes, the construction of a folk biology might proceed by processes that are not unique to the domain. For example, Gelman and her colleagues (Gelman & Hirschfeld, in press) may be right that a general essentialist bias could provide the inferential engine that drives children to discover causal mechanisms that underlie a coherent folk-biological domain. In short, I submit that it is not implausible that children could come to construct an adult folk biology, with the universal characteristic Atran has described, from more limited innate constraints and more general learning mechanisms.

A final comment: Mention of Roger Brown's (1958) concept of the level of usual utility has been conspicuously absent in recent discussions, even though it introduced to psychology the notion of a privileged level of naming and classification. His work is worth noting, even beyond historical fastidiousness, for his emphasis on "the functional structure of the . . . world" (p. 16) is still relevant to research on cultural differences in classification judgments.

## Are folk taxonomies "memes"?

Dan Sperber

CREA, Ecole Polytechnique, 75005 Paris, France.  
sperber@poly.polytechnique.fr

**Abstract:** This commentary stresses the importance of Atran's work for the development of a new cognitive anthropology, but questions both his particular use of Dawkins's "meme" model and the general usefulness of the meme model for understanding folk-taxonomies as cultural phenomena.

The American "cognitive anthropology" of the 1960s and 1970s (reviewed in D'Andrade 1995) focused on the study of individual "cultural competence" as revealed in folk classifications. Notwithstanding some major advances achieved from this early cognitive anthropology (the most famous being Berlin & Kay [1969] on color classification; see also Saunders & van Brakel: "Are There Nontrivial Constraints on Colour Categorization?" *BBS* 20(2) 1997.), its cognitive dimension was shallow and its anthropological dimension amounted to little more than doing cross-cultural comparisons, with little interest in social-cultural mechanisms. In particular, hardly any attention was paid to domain-specific cognitive mechanisms on the psychological side, or to processes of cultural transmission on the anthropological side. In the 1970s and 1980s, biologically oriented researchers developed Darwinian models of cultural transmission but paid little or no attention to cognitive mechanisms (see Boyd & Richerson 1985; Cavalli-Sforza & Feldman 1981; Dawkins 1976; Durham 1991; Lumsden & Wilson 1981). In the 1980s, developmental psychologists (e.g., Susan Carey, Rochel Gelman, Susan Gelman, Frank Keil, Alan Leslie, David Premack, Elisabeth Spelke), evolutionary psychologists (e.g., David Buss, Leda Cosmides & John Tooby, Donald Symons), and some cognitive anthropologists (Scott Atran, Pascal Boyer, Lawrence Hirschfeld, Dan Sperber) converged on the idea that the human mind contains several, possibly many, domain-

specific conceptual mechanisms (comparable to Fodor's input modules, but at a conceptual level). The relevance of this view of the human mind to the understanding of human culture, and the need to integrate it with the study of cultural transmission was highlighted at the conference on "Domain specificity in cognition and culture" held at Ann Arbor, Michigan in 1990 (Hirschfeld & Gelman 1994, see also Tooby & Cosmides 1992). Atran's work (along with that of Boyer [1994] and Hirschfeld [1996]; see also Sperber [1996b]) is an outstanding contribution to this new wider and deeper cognitive anthropology.

One particular merit of Atran's contribution is that it articulates the individual cognitive dimension with a macro-historical dimension. He shows how the historical development of natural history is rooted in a cognitive disposition to order living kinds in a domain-specific way. However, although he makes some interesting suggestions, he glosses over the articulation of individual cognition and micro-processes of social transmission, and this is where I would like to propose some constructive criticism.

In section 1.3, Atran chooses to borrow Dawkins's (1976; 1982), term "meme," giving it a new twist. He proposes distinguishing two kinds of memes: "core memes," such as folk-taxonomies of living kinds, and "developing memes," such as scientific research programs. Core memes, he argues, replicate more easily and with a higher degree of fidelity than developing memes. Unlike developing memes, core memes do not need institutional support or the help of metacognitive abilities to replicate. Their existence helps explain commonalities across cultures that are not the result of common descent or diffusion.

Dawkins's original "memes" are genuine replicators: They are items in the mind of individuals that cause behaviors that cause replicas of those very items to be constructed in the minds of others. There may be more mutations of memes than there are of genes, but for the whole idea to be a serious explanatory proposal rather than a loose and potentially misleading analogy, it is essential that the rate of mutation still remain low enough for the Darwinian model of selection to apply. I have argued (Sperber 1996b, Ch. 5) that most transmission of information among humans involves some degree of transformation of the information; hence the replication-cum-selection model is not generally applicable. The stability of cultural phenomena such as myths, rituals, techniques, folk-taxonomies, moral codes, and so on is, in general, caused not by genuine processes of replication, but by the fact that the transformations involved in transmission tend to cancel one another out by gravitating toward the same point in the space of possibilities (hence I have argued that cultural evolution is to be explained in terms of attraction rather than selection). The taxonomies Atran discusses are good examples of this.

As examples of "core" and "developing memes" Atran cites folk-taxonomies and scientific programs, that is, large conceptual systems. Their transmission to any one individual typically involves repeated interactions with many people over many years. Moreover, although it is true that a folk-taxonomy is a highly stable component of a people's culture, this does not imply that all or even most adult members of a society have the same mental taxonomy. On the contrary, degrees of competence vary greatly, and most individuals have only an incomplete and idiosyncratic version of the global folk-taxonomy of their culture. Not all people know the same plants, for example, or the same things about the plants they know. Even experts often disagree. In oral cultures (e.g., the Dorze of Southern Ethiopia, where I did my anthropological fieldwork), experts typically disagree more than they are aware, because their respective mental taxonomies are only confronted occasionally, a propos of specific plants or animals, and cannot be matched to any permanent, written, canonical version. The stability of folk-taxonomies is not an effect of "high-fidelity copying," but of the fact that most "failure of copying" results in mere lacunae rather than divergences, and divergences among experts tend to concern only marginal instances. This is very different from genetic replication, where failure to copy chromosome fragments typically amounts to mutation.

The meme model could be defended here by arguing that the real memes – that is, the real replicators – are not whole taxonomies, but individual taxons such as the concept of an oak, or that of a sparrow (whereas whole taxonomies are only “memelike” by extension). With oaks and sparrows, indeed, a single interaction (e.g., pointing and naming) between knowledgeable individual and an ignorant one may be enough to cause the latter to acquire a version of the concept of the former. Individual words, and, among words, proper names and living-kind terms, are possibly the best candidates for meme status. Showing that they themselves are not very good replicators should cast doubt on the validity of the whole meme model.

Word phonology is copied from speakers by language-learners. Moreover, to learn, say, the word “oak” (not just the sound, but also the meaning) is, arguably, to deploy, even if imperfectly, the ability to refer to oaks and only to oaks as “oaks.” So it might seem, that not just the sounds of words, but also their meaning gets faithfully copied. Well, not quite. From the causal-explanatory point of view, which is the only one that matters here, two individuals may use the same phonetic form to denote the same things and yet do this by means of mental structures that are otherwise functionally quite different in that they have different possibilities for making inferences.

I am convinced by Atran’s claim that users of the word “oak” mentally represent it as a taxon of specific rank, denoting a kind with an underlying essence. However, individuals’ views of the essence of oak determine their inferences, expectations, and so forth; in other words, much of the role “oak” plays in their mental lives and, in particular, in their decision to communicate about oaks, and so forth. Different individuals may have different views of the oak essence. The same denotation does not amount to the same concept in the psychological sense of the term where a concept is best seen as a knowledge structure. The stability of folk taxonomies may be caused on the one hand, by the innate disposition Atran discusses, and on the other by the relatively high discriminability of living kinds in local environments. This is enough to secure identity of reference and of the general format for living kind terms. However, actual mental concepts thus anchored in their referents may well vary from individual to individual in their content. If so, the actual concepts do not replicate, they merely generate, through communication, versions gravitating around some prototype of their common referent.

As I mentioned, living kind terms are, *prima facie*, among the very best candidate for meme status; yet a careful look at micro-processes of transmission and acquisition suggests that there is much more idiosyncratic construction and variation than the meme model would predict. Most other candidates for meme status are even much less “memelike.” What Atran calls “developing memes” such as scientific programs, are, just like folk-taxonomies, transmitted in a piecemeal fashion, and with much poorer replicability, as all science teachers know. Moreover, it is part of the scientific enterprise to try not to replicate but to augment, correct, or subvert previous scientific concepts, theories, and so forth. Atran’s own version of Dawkins’s “meme” is best described, if not as a “failure to replicate,” then as a deliberate modification of the original idea. The idea of a meme in its many forms has done much work for us as an insightful metaphor. Now the insight should be converted into some serious theorizing in which the strict notion of a meme (i.e., a cultural replicator) may have little role to play, and where a loose version of it is best avoided altogether.

## Cognitive universals, hierarchy, and the history and practice of biological systematics

P. F. Stevens

Harvard University Herbaria, Cambridge, MA 02138.

pstevens@oeb.harvard.edu

**Abstract:** The hierarchical reach of Atran’s cognitive universals is unclear, and some of the key concepts used to discuss them are notorious for their imprecision. Although ideas of class hierarchy pervade Atran’s discussion, other ways of thinking are also allowed. The history and practice of systematic biology suggests that a nonclass hierarchical and continuity-based way of thinking has been common there until recently.

If there are cognitive universals that structure biological classification in particular, rather than classifications in general, then our understanding of the history of systematics, as well as its present practice, will need revision. For Atran, a cognitive universal for humans is the existence of a rank of generic species, a “causally essential category” (sect. 1.3, para. 14). Generalisations and predictions are made about members of this rank, as shown by experiments on the Itzaj and Michigan students that Atran reports; indeed, he explains away those parts of his results that do not quite fit (sect. 1.2.2.3, para. 1). But Atran repeatedly suggests (sect. 1.1, para. 1; sect. 1.3, para. 1; conclusion, para. 1) causal relations between different hierarchical ranks. Although the general structure of classifications is similar (Holman 1992), exactly how deeply Atran expects cognitive universals to extend into the hierarchy is unclear.

Furthermore, several concepts important for understanding the ideas and experiments discussed are imprecise. Thus, phenomenal salience is linked with phylogenetic isolation (sect. 1.2, para. 2), and attempts made to compare “readily perceptible evolutionary gaps” (sect. 1.2.2.3, para. 3) across environments. However, cacti (for example) are not genealogically isolated and can be grafted with plants of two other families; so what is meant by phylogenetic isolation or evolutionary gaps?

Although the distinction between life and nonlife is critical if folk biology is a core domain, Atran is uncertain exactly how folk make this distinction (sect. 1.3, para. 8). Western systematics took a long time to distinguish between animate and inanimate objects and between plants and animals. My reading of the literature in which children’s categorisation of the world is explored is that plants are not conceptualised in exactly the same way as animals, although they are certainly not treated like inanimate objects, either.

Atran is interested in the extent to which folk practice is evident elsewhere. He discusses the differences between Michigan students and Itzaj in diversity-based (hierarchical, taxonomic) reasoning; Americans commonly reason this way, and the Itzaj do not (sect. 2.1.2.3-4; sect. 2.1.3). Atran also suggests that science has a marginal role for American folk; they do not have the theories to make successful diversity-based predictions. However, diversity-based reasoning is itself broadly consistent with evolutionary theory, and may have been one thing the student picked up from their classes. Their classification – also theories, but at a lower level – may be wrong, but that is another matter. So scientific theory may affect taxonomy via how classifications or relationships (used in a general sense) are interpreted – which is in part how evolutionary theory affected systematics.

The last two paragraphs introduce a recurring theme in systematics. The cases of nondiversity-based reasoning are basically “folk” examples (Note 14), but our understanding of the living world is clearly not mediated by hierarchical relationships alone. O’Hara (1996) suggests that beginning college students often see relationships as being directly between extant groups, not hierarchically. Similar ways of understanding nature have been prevalent in systematics (Cuerrier et al. 1996; Stevens 1994b); the *scala naturae* is only one example of this. Indeed, in the eighteenth and early nineteenth century philosophers and naturalists like Adam

Smith, Buffon, and Cuvier took various forms of continuity to be the result of the ordinary reasoning or grouping practices of the “bulk of mankind” (Stevens 1998). It may be that this style of thinking, although still common, has no place in scientific classification (sect. 2.1.2.3, para. 7), but how does it relate to hierarchy and Atran’s cognitive universals?

Western ideas of classification develop from within a matrix in which this style of thinking is common. Indeed, much in Atran’s description of the development or practice of systematics needs further analysis. I raise only a few points here: (1) Gilmour’s advocacy of general-purpose classifications (sect. 2.2) is more the exception than the rule. It has long been conceded that keys allow the identification of organisms, because the formal groups into which organisms are put may not be readily identifiable (Stevens 1994b). (2) Changing ideas of relationships (sect. 3, para. 3) may not change the kind involved – that is, the limits of the group may remain unchanged – but they change our understanding of it, and any predictions we might make about it. In such circumstances, what of folk taxonomy remains intact is unclear. (3) It is not clear why Aristotle’s ideas should fail because he was trying to explain a familiar order of things (sect. 3.1, para. 4; also see sect. 2.1.1.2, para. 5 for a similar argument emphasising the need to see many examples before something is “correctly” understood). Certainly, for the essentialist Louis Agassiz, the world remained the same whether there was 1 or 10,000 crustaceans.

Atran has yet to make his case fully. However, clarifying the nature and extent of cognitive universals will lead to a better understanding of the relationship between the local and the global, between “folk” and “science.”

## The living individual and its kind

Michael Thompson

Department of Philosophy, University of Pittsburgh, Pittsburgh, PA 15260.  
mthomps+@pitt.edu

**Abstract:** The empirical advances the target article makes over Atran (1990) tend not so much to enrich our knowledge of the “folk taxonomic” hierarchy as to militate against the idea of one. Folk-biological domain-specific universals are to be found not in “taxonomic” kind-kind subordination relations, but in the relation of individual organisms to low ranking kinds and in the peculiarities of those kinds.

**The upper ranks.** If concepts are to be ranged in a hierarchy, they must exhibit some fundamental homogeneity. But on Atran’s new evidence the joining of “folk kingdom” and “life form” concepts together with the others in a hierarchy begins to seem a rather mechanical assimilation, founded, despite his intentions, on a covert imputation of aims akin to those of modern systematics.

Itzaj alarm at “folk kingdom” inductions corroborates the traditional philosophical idea that such terms express something closer to “pure” concepts than anything called a “taxon” could: By an animal or a “critter,” we mean a perceiving, feeling, “self-moving,” or “animate” being; any other kind of life we consign to the status of vegetation. The ideas are very abstract. Folk *plant* and *animal* terms may suffer a bit of terrestrial empirical encrustation, and a kingdom *Animalia* might be named, but surely neither Itzaj nor the taxonomist need detect any metaphor in the sentence, “Those critters they brought back from Jupiter last week – man, they give me the creeps.” Does our innate taxonomic impulse tend to hierarchies with *cosmic* reach?

As for “life form” concepts, has even Atran quite shaken the effects of the accidental formation of a few such scientific taxa as *Aves* – which, apart from bats, cassowaries, and so on, is extensionally close to folk “bird” ideas? Itzaj horror of “life form” inductions again seems to show that the unity of one thing with another under the concepts *tree* and *bird* was never intended to be comparable with the unity caught by *oak*, *white oak*, and *spotted*

*white oak*. On Atran’s evidence, their logical position looks more and more like that of *evergreen plant* and *nocturnal animal* – as Itzaj “mammal” is literally “walking animal” (sect. 1.2.2.1, para. 2), a phrase that intuitively opposes “mammals” to, say, crawlers, slitherers, swimmers, fliers-proper, and mere buzzers-about. These are not “names of taxa”; they are nothing like names.

**The lower ranks.** Evidence for an innate hierarchical impulse expressed in named taxa must, I think, be found in the common structure exhibited by the myriad three-rung mini-hierarchies at the lower ranks. Call concepts falling on the bottom three rungs “living kind” concepts, and the activity of forming them “life pattern recognition.” Suppose, as Atran does in other terms, that the latter is a genuine domain-specific universal with a cognitive basis. Need we posit a *second* such innate tendency to ground the felt similarity of linguistically given series like *oak/white oak/spotting white oak* and *culture/black culture/red-headed black culture*?

Why not take the dull empiricist road instead, and blame those crude low-to-the-ground Darwinian facts, which the human brain, structured for “life pattern recognition” pure and simple, and planted in a particular culture, must so frequently confront even in the limited fraction of the biosphere within which traditional cultures operate? Where its turf cannot hide the effects of comparatively recent variation and selection, the blunt “life pattern” faculty finds several ways to answer its vague prehistorical question: “What is this?” or “What is ‘the same’ as this?” – broadly in *oak* and *dog*, a bit more narrowly in *spotted white oak* and *toy poodle*. So hierarchy happens. The “speech-pattern” series *English/American English/Pittsburgher dialect* and *German/Bayrisch/Muenchendalekt* register a like empirical tragedy with familiarly kindred causes. Is the question: “What are they speaking?” intrinsically hierarchical, or just a bit vague? (Note that, like *vertebrate* and *mammal* in the other case, and for similar reasons, the linguistic “higher taxa” *Indo-European* and *Germanic language* supply bad answers.)

The Itzaj restriction of reputable kind-kind inferences to the lower ranks again needs no hierarchical explanation. The more promising inferences are underwritten by the *individual-kind* principle Atran alludes to in section 1 (para. 1) but, strangely, does not investigate: the type found in “These five *A*s *hic et nunc* have *n* bones in their tails, so probably *A*s in general typically have *n* bones in their tails,” which surely presupposes that *A* is a low-rank, genuine living kind. But if *Jerseys* are typically *F*, then presumably a number of *individual cows* are *F*, so, by the nonhierarchical principle, maybe cows are typically *F* as well.

**The living individual and its kind.** On Atran’s evidence, the bottom ranks seem to fuse, in point of cognitive basis, whereas the top ranks drift away. Why were the prospects for a folk *biology* ever bound to the hope of a folk *taxonomy* of kind-kind subordination relations? We might look instead to low-grade, folk-biological, *individual-kind* relations and to the peculiarities of thought about such kinds. It is at just this point that Atran reaches for dark phrases like “essence,” “nature,” and “invisible causal unity.” Are we so familiar with hidden essences, though, that we must certainly know what he means? It is striking, here, that Atran offers as terms of induction only propositions of the forms “All/few/no *A*s are *F*.” What about the very different *generic* propositions, “*A*s are *F*,” “*A*s are typically/characteristically *F*,” “The *A* is *F*” – and the more complicated forms “Female/juvenile/worker *A*s are typically *F*,” “In spring/during mating/on pollination *A*s are *F*,” “The eggs/nest/eyes of an *A* are *F*” (Carlson & Pelletier 1995). These are the peculiar element of natural historical description, and are given a particular turn in it (Thompson 1995). The pattern-expressing “stories” thus constituted exhibit a sort of interpretative unity, and a more complex relation to induction and cause than has so far been envisaged: “The eggs of a mosquito develop thus . . . ,” I might tell you, thanking God that only a minute fraction ever do. Might not “essence,” “nature,” and the taxonomical emphasis distract the student of “folk biology” from the detailed study of such everyday employments of living-kind concepts?

## Pulling the trigger on the living kind module

Peter M. Todd<sup>a</sup> and Alejandro López<sup>b</sup>

<sup>a</sup>Center for Adaptive Behavior and Cognition, Max Planck Institute for Human Development, 14195 Berlin, Germany; <sup>b</sup>Department of Computer Science, University of Hamburg, 22527 Hamburg, Germany. [ptodd@mpib-berlin.mpg.de](mailto:ptodd@mpib-berlin.mpg.de) [www.mpib-berlin.mpg.de/users/ptodd](http://www.mpib-berlin.mpg.de/users/ptodd); [alelopez@puc.cl](mailto:alelopez@puc.cl)

**Abstract:** Atran conjectures that a triggering algorithm for a living-kind module could involve inputs from other modules that detect animacy and intentionality. Here we further speculate about how algorithms for detecting specific intentions could be used to trigger between- or within-species categorization. Such categorization may be adaptively important in Eldredge's energy and information realms.

How might we expect that human mind to be designed to carve up the natural world? On the one hand, those species that Atran indicates humans most readily perceive – vertebrates and flowering plants – have evolved to be distinguishable largely through the categorizing abilities of brains and perceptual systems (Todd & Miller 1997). Animal species are generally self-defining entities that are kept reproductively isolated from other species through sexually selected traits and the nervous systems that evaluate and make choices based on them. Many salient aspects of flowering plants have similarly been shaped through coevolution with the categorization mechanisms of the animal species that pollinate them. It is perhaps not surprising, therefore, that our own psychology has evolved to apprehend and appreciate the diversity of species created by the selective action of other behaving organisms.

On the other hand, there is no reason to reason – to make connections between categories, or even to categorize the world at all – if such mental work does not serve an adaptive function. That is, we should not expect to be designed to think about the natural world in terms of categories of other species and individuals within our own species, unless these distinctions help us with the adaptive tasks of survival and reproduction. Atran indicates that knowing the habits and relationships of different species “would be likely to increase the effectiveness (benefit) of such knowledge-based subsistence immeasurably” (sect. 1.3) – but can we be any more specific than this? If we can say more clearly when species-level categorization might give an individual an adaptive benefit, we could also form new hypotheses about when and how this type of domain-specific reasoning could be triggered.

Eldredge (1986) distinguishes two domains in which all organisms must function: the energy domain, procuring the physical elements necessary for survival, and the information domain, ensuring the spread of copies of one's own genetic makeup via reproduction. Other species are (usually) only of concern in the former domain: they can be a source of body-building compounds as prey, or of energy-draining injuries as predators, but not of additional genetic information for recombination and reproduction. Instead, only members of one's own species can provide such relevant genetic information, so they are crucial for the second domain. Energy and physical resources are not individuated – they are essentially the same in all members of a given species – so there is no need to distinguish between members of another species. In contrast, genetic information is unique to individuals, so it matters who is chosen as a mate, or with whom one engages in preferential treatment (i.e., offspring and kin). This difference of individuation between the energy and information realms can explain the adaptiveness of categorizing at the species level outside one's own kind and at the individual level within.

Thus, species-level categorization will primarily be invoked in adaptive problems contained within the energy/resource/survival domain. Within that domain, it is important to know when such an adaptive problem is being faced, for example, when a predator is threatening, or when a prey animal is fleeing. These are the instances in which it may be most important to generalize behavioral knowledge about the species as a whole to the current situation at

hand. We have explored a simple visual cue-based algorithm for judging intention from motion in just such instances (Blythe et al. 1996). We had participants generate motions of two moving “bugs” on a computer screen, corresponding to simple intentional categories including pursuit, evasion, fighting, courtship, and play. Other participants were later able to categorize the intentions of the “bugs” with high accuracy from their trajectories alone. This study supports the notion that animate intention can be determined using only a few simple spatiotemporal cues (which include, from trajectory analysis, relative heading, relative distance, relative velocity, and vorticity or “loopiness”). Knowing the intention (as opposed to the general intentionality that Atran mentions) of another organism can trigger the appropriate domain-specific mechanism for response, including species-level categorization and recall of relevant traits.

It is of course important as well to know the intentions of other organisms within one's own species, which can have an effect in the information or energy domains (e.g., courting or fighting, respectively). In humans, these intentions can be revealed – and the appropriate domain-specific reactions triggered – not only through gross bodily movements, but also through verbal cues. We have developed a simple, “fast and frugal,” intention-judging algorithm based on this type of linguistic information as well (López et al., in press). Although this algorithm does not directly connect with Atran's core module for carving up the natural world of other species, we mention it here to provide another example of how a simple triggering algorithm can invoke further domain-specific reasoning mechanisms, and to point out the importance of this kind of higher-level “director” mechanism in human cognition.

The Pragmatic Cues (PC) algorithm maps conditional statements – if P, then Q – onto social domains. Humans regularly use such conditional statements to make promises and threats, offer advice and warning, and give permission and obligations to other people. But how do we know when we are facing a promise, or a threat, or something else? According to the PC algorithm, we simply traverse a binary decision tree based on just three pragmatic cues that sequentially prune the possibilities until a single social domain is left. The cues are the following: Is Q (the consequent) a benefit for the speaker? Does Q involve an act of the speaker? Does Q enable or obligate an act of the listener? Given just these three simple cues, the relevant social domain can be determined – the PC algorithm categorized the conditionals in our test-set onto social domains 5 times better than chance and just slightly worse than people (average across domains was 85% for the algorithm, and 94% for human raters).

Mental mechanisms like these for triggering domain-specific behaviors, whether based on motion cues of other species or verbal cues from our own species, must be fast and hence use as little information as they can get away with (Gigerenzer & Todd, in press). As a consequence, as Atran indicates, these simple algorithms can sometimes make mistakes, leading us, for example, to overgeneralize animacy and intention to moving computer images. But such false alarms are probably a lower-cost mistake than missing the cues of animacy of real organisms in the environment. In our rather environmentally impoverished intention-from-motion studies, some participants were certain that the “bug” they were seeing on a computer screen was being moved by a program on the computer itself, rather than by another participant in a separate room (as was the case). In the jungle, however, to mistake the movement of leaves as caused by the wind rather than the jaguar lurking there could be costly indeed.

# Author's Response

## Taxonomic ranks, generic species, and core memes

Scott Atran

Centre National de la Recherche Scientifique, CREA (Ecole Polytechnique)  
75005 Paris, France and Institute for Social Research, The University of  
Michigan, Ann Arbor, MI 48106-1248. [satran@umich.edu](mailto:satran@umich.edu);  
[atran@poly.polytechnique.fr](mailto:atran@poly.polytechnique.fr)

**Abstract:** The target article contains a number of distinct but interrelated claims about the cognitive nature of folk biology based in part on cross-cultural work with urbanized Americans and forest-dwelling Maya Indians. Folk biology consists universally of a ranked taxonomy centered on essence-based generic species. This taxonomy is domain-specific, perhaps an innately determined evolutionary adaptation. Folk biology also plays a special role in cultural evolution in general, and in the development of Western biological science in particular. Even in our culture, however, it retains an autonomy from other domains of thought and from science. These claims are questioned and clarified.

### R1. Clarifying rank

**Morton** wishes to clarify rank by casting it in terms of the branching patterns of inclusive class hierarchies, thus making rank an emergent property of a certain hierarchical class-inclusion structure. He suggests that concepts at the preferred biological (generic-species) rank have roughly the same number of concepts dominating and being dominated by them and that the preferred (basic-level) concepts in nonbiological hierarchies dominate fewer concepts than do generic species.

*Response:* Although I appreciate **Morton's** efforts to clarify the rank concept, his reformulation appears to go in the wrong direction. Empirically, generic species are more often than not monotypic; that is, they do not taxonomically dominate any concept (Atran & Ucan Ek', in press; Berlin et al. 1974; Hays 1983; Hunn 1977). Conceptually, Morton's reformulation leads to confusion between the basic level of an inclusive class hierarchy and the generic-species rank, as when he mistakenly surmises: "Tree and fish are at the generic species rank, in contrast to the alternatives maple and trout." Logically speaking, rank is a second-order concept that is defined over (and not in terms of) first-order class hierarchies.

The concept of rank is motivated in part by the apparent dissociation between preferred taxa and terminal taxa (i.e., taxa having no subkinds). Although the majority of terminal taxa in a given folk biological taxonomy may be preferred, a large minority are not. For example, among some folk in Michigan, the class of terminal taxa includes bat, squirrel, weasel, beagle (dog), collie (dog), calico (cat), short-haired tabby (cat), long-haired tabby (cat), and so on. Only the first three (bat, squirrel, and weasel) are preferred taxa, that is, generic species. The class of terminal taxa is an example of an emergent level that can be characterized in terms of the branching patterns of an inclusive class hierarchy. Although anthropologists (Lévi-Strauss 1966) and psychologists (Rosch 1975) have read cognitive significance into the terminal level (e.g., its variability across cultures and its divergence from scientific classifications of species), it is in fact psychologically spurious.

Formally, a ranked taxonomy (RT) may be partially characterized as follows:

1. RT is headed by the (named or unnamed) categories animal and plant, which are *folk kingdoms* (FK). A FK is a maximal taxonomic category with respect to a "kind of" relation, **K**, such that:

- 1.1. **K** is a two-place, acyclic relation with a finite domain, **T**\* (i.e., for no sequence,  $x1, \dots, xn$  of members of its domain do we have  $x1 \mathbf{K} x2, \dots, xn-1 \mathbf{K} xn, xn \mathbf{K} x1$ );
- 1.2. **K** is transitive over every taxonomic category, **T** (i.e., any subset of its domain).
- 1.3. No item is of two distinct kinds unless one is a kind of the other (i.e., for any members  $x, y, z$  of **T** such that  $x \mathbf{K} y$  and  $x \mathbf{K} z$ , either  $y = z$  or  $y \mathbf{K} z$  or  $z \mathbf{K} y$ ).
- 1.4. Every **T** consists of a head item ( $h$ ) and everything in **T**\* that is a "kind of"  $h$  (i.e., for some  $h \in \mathbf{T}^*$ ,  $\mathbf{T} = \{h\} \cup \{x/x \mathbf{K} h\}$ ). Taxon  $h$  is then called the *head* of taxonomic category **T**.
- 1.5. It follows that the set **T**\* of taxa with respect to **K** is partitioned into disjoint taxonomic kingdoms with respect to **K**. The head of a **K**-kingdom (i.e., plant, animal) stands in relation **K** to no member of **T**\*.

2. For each FK there is a ranking **R**, such that each rank with respect to **R** has a special conceptual status within the system of folk concepts. A *ranking* of **T** with respect to **K** is a function **R** from set **T** onto a set of consecutive integers  $\{m, \dots, n\}$ , with  $m < 0$  and  $n > 0$ , which satisfies the following condition:  $(\forall x, y \in \mathbf{T})$  [if  $x \mathbf{K} y$  then  $\mathbf{R}(y) > \mathbf{R}(x)$ ]. The integers  $m, \dots, n$  in the range **R** are called *ranks* with respect to **R**, and  $\mathbf{R}(x)$  is the *rank* of  $x$  with respect to **R**.

- 2.1. Rank  $n$  is the rank of *folk kingdom* (FK).
- 2.2. Rank 0 is the rank of *generic species* (GS)
- 2.3. Rank  $n-1$  is the rank of *life form* (LF)
- 2.4. Rank  $-1$  is the rank of *folk specific* (FS)
- 2.5. Rank  $-2$  is the rank of *folk varietal* (FV)
- 2.6. Rank  $-3$  is the rank of *folk subvarietal*
- 2.7. Taxa (named or unnamed) falling between ranks  $n-1$  and 0 are *intermediate*

3. In any system of folk concepts, FK and GS (i.e., ranks  $n$  and 0) are mandatory in the sense that every terminal kind is a subkind of some taxon of that rank, such that:

- 3.1. A *terminal* kind has no subkinds (i.e.,  $x$  is terminal for **K** if and only if  $x$  is in the domain of **K** and there is no  $y$  such that  $y \mathbf{K} x$ )
- 3.2.  $\forall x[x \text{ is terminal} \rightarrow (\mathbf{R}(x) = i \vee \exists y(y \mathbf{K} x \ \& \ \mathbf{R}(y) = i))]$ .
  - 3.2.1. It follows that if **T** is a taxonomic category, the maximal rank  $n$  of the head of **T** is mandatory.
  - 3.2.2. It also follows that if a level is mandatory, it partitions the taxa at that level or lower (into mutually exclusive groups of organisms).

4. It remains an open question whether or not:
  - 4.1. LFs are mandatory. If so, then apparently unaffiliated generic species are in fact monotypic life forms; that is, the LF and its single GS are extensionally (perceptually) equivalent but conceptually distinct.
  - 4.2. Some intermediate taxa are ranked. If so, any such intermediate taxon is a subkind of some life

form, such that:  $(\forall x \in \mathbf{T}) [\mathbf{R}(x) = n-2 > \exists y(x \mathbf{K} y \ \& \ \mathbf{R}(y) = n-1)]$ .

5. In the historical development of Western systematics:
  - 5.1. Rank  $n$  became the biological Kingdom (Cesalpino 1583).
  - 5.2. Rank 0 fissioned into ranks 0, the Species, and Rank 1, the Genus (including monospecific genera) (Tournefort 1694).
  - 5.3. Rank  $n-1$  became the biological Class (Linnaeus 1738).
  - 5.4. Rank  $n-2$  was initially formalized as the biological Family (Jussieu 1789).
  - 5.5. Taxa below Rank 0 became unranked infraspecific groups (Darwin 1859).

## R2. Are folk biological universals too weak or too strong to make sense?

**Leiber** implies that the evidence I bring to support folk biology as an evolutionary core domain of human cognition warrants treating it as an informationally encapsulated Fodorian module, on a par with universal grammar. In other words, other parts of the mind should neither influence nor access the internal processing of living-kind concepts, only its outputs, he argues that we should treat folk psychology likewise and suggests that my reluctance to do so stems from an anthropological bias to allow cultural influences to play a significant role in my account. This may in turn be responsible for my “orgy of relativism, antimaterialism, and science-bashing.”

*Response:* Regardless of the role of cultural influence, conceptual processing of living kinds (or people’s intentions) does not appear to be so encapsulated as to exclude access to information from top-down processes: the output of processing from naïve physics may be crucial input to conceptual awareness of spontaneous animate motion; awareness of animate notion may in turn be crucial input to awareness of intention, and so forth. About science, **Leiber** misinterprets me. My claim is that, from the vantage of our own evolutionary history, it may be more important to the everyday life of our species (or at least to aspects of everyday life that we evolved to be sensitive to) that our ordinary concepts should be adaptive than that they be true. Reliance on folk versus scientific concepts may depend on context. Belief in essences, for example, may greatly help people explore the world by prodding them to look for regularities and to seek explanations of variations in terms of underlying patterns. Essentialism is an intuitive folk notion that allows humans to understand that a caterpillar, chrysalis, and butterfly are essentially the same organism. This strategy may help bring order to ordinary circumstances, including those relevant to human survival. In other circumstances, such as wanting to know what is correct or true for the cosmos at large, folk concepts and beliefs may hinder more than help. Even in some everyday matters, the tendency to essentialize (e.g., races) or explain variation in terms of deviation from some essential ideal or norm (e.g., people as mental or biological “deviants”) can be an effortlessly “natural” but wrong way to think.

Science teaches us that we can do better than merely get by with what we are born to deal with easily. The task of the anthropology of science is to explore the scope and limits of common sense to help us better understand the develop-

ment and objectives of science. For example, it helps us better understand why it is so hard to teach biology students evolutionary theory, and why it is so hard to get psychologists and philosophers to stop talking as if biological species were natural kinds with lawful natures or metaphysical essences.

**Saunders** argues that claims about the existence of universals are hopelessly question-begging: no imaginable empirical argument could dislodge or disprove them and it can never be shown that “a living thing/being module is informationally encapsulated” in Fodor’s sense.

*Response:* I am not sure I follow the argument. Specific empirical claims were made about categorization and category-based reasoning. In some cases our hypotheses were experimentally confirmed (e.g., there is a taxonomically preferred level that corresponds roughly to the biological species or genus), and in other cases they were disconfirmed (e.g., that the principle of diversity in taxonomic reasoning would be universally manifest). As **Leiber** stresses, I argue against – not for – encapsulation in Fodor’s sense. **Saunders** implies that the encapsulation argument could not work in principle and by that implication neither could any claim for domain specificity – even for universal aspects of syntax and phonology – because modules (cognitively based specific domains) are a “theory.” This seems to have no more force than the argument that claims for the existence of DNA or chromosomes are impossible to dislodge because molecules or genes are a “theory.” I do not deny that there may be an infinite number of alternate and equally correct or true interpretations of data or behavior that can be expressed in other conceptual or cultural idioms. What I claim is that this is a good candidate for the best fitting hypothesis available, given the present state of cognitive psychology and anthropology.

## R3. Folk biological universals, yes; innate domain-specificity, no

**Lillard’s** argument is contrary to **Leiber’s**: folk biology, like folk psychology, has no specific evolutionary or innate component. Lillard cites anthropological reports that Samoans or Sherpas “appear to be reluctant to surmise about others’ mental states.” Belief that other people have mental states like our own and that those states are causal constituents of behavior is not innate, but learned on the basis of cultural norms. Lillard suggests that my evidence for the universality of folk biology is prima facie stronger than evidence for the universality of folk psychology, although “learning can also explain the data Atran presents.” For example, “one learns early in life that individuals of a species beget other individuals of that species”; furthermore, adults know this better than 6-year-olds, who know better than 4-year-olds, and so on.

*Response:* Concerning the absence of folk psychology in other cultures, I place no stock in anthropologists’ anecdotal interpretations of people in other cultures having no concept of mind. Such claims, although meant to awe us with the intellectual diversity of humankind, often prove unconvincing on deeper analysis. Except for certain phenomena tied to linguistic morphology, I have found that most of the variation that is reported in the ethnographic literature to distinguish our culture from others is also represented (under different distributions) in our own culture.



Nor am I convinced by allied claims that different linguistic structures wholly preclude or make possible certain interesting classes of psychological phenomena (e.g., the supposed lack of a notion of agency in so-called ergative languages where the subject of intransitive sentences is treated like the object of transitive sentences). I am willing to be surprised by experiments that suggest failure of people in other cultures to entertain false beliefs, pretend, learn by ostension, express the desires of others, read a mother's mind by her gaze, or recognize the anthropologist's intention to get information from them. Experiments showing a lack of any of these phenomena (after maturation in a person's mind during the first few years of life) would be startling insofar as all appear characteristic of folk psychology. As for the fact that adults and older children understand species reproduction better than younger children do, note also that adults and older children have more developed notions of object weight (gravity), passive form in language, other people's intentions (e.g., in terms of motivations and emotions), and so forth. But younger children still have concepts of rigid objects and generic species, syntactic structures, propositional attitudes, and so forth.

**Livingston** also conjectures that domain-general mechanisms can explain folk biological universals, under two assumptions: (1) classification is restricted by the goals of the category learner, and (2) the world is a structured place, with inherent similarity patterns that will exercise themselves on the mind whatever the learner's goals.

*Response:* The trouble with the first assumption is that there are as many possible goals as possible interests. There are indeed a wide variety of different and overlapping classification systems for biological kinds within and across cultures. Nevertheless, there also appears to be only one general-purpose classification in every culture that guides biological induction. In the Medin et al. (1997) findings, for example, the goal-directed classification of landscapers did *not* guide inductions about the distribution of biological properties across organic groupings.

The second assumption would explain the universality of general-purpose classification: the causal structure of the organic world comes in limited varieties that the mind basically photographs and assembles into a picture by means of some set of general associationist-connectionist principles. The underlying causal "laws themselves are discoverable by (domain-general) concept learners" – although, even as the empiricists acknowledged, God only knows how this could be done. Perhaps causality itself is a domain-general notion, but if so, it would not suffice to account for the variety of causal explanations humans typically use. This allows us to reconsider the first assumption about goals back in the side door to play a secondary role in accounting for the residual variation between cultures.

The rank induction experiment indicated that biological inference is not guided by any of the proposed domain-general mechanisms for judging biological similarity (e.g., Hunn 1976; Osherson et al. 1990; Rosch 1975). Although lexical knowledge may help the learner target generic species, language by itself provides no reason to prefer generic species for induction. Neither do patterns of nomenclature necessarily isolate generic species from taxa of other ranks (e.g., mammal, dog, collie; tree, apple tree, winesap; bird, robin, mountain robin). **Livingston** suggests that my reasoning should also lead to the awkward hypothesis of domain specificity for containers, given that people

in America and China sort bottles and jars into similar groups despite structural differences in their respective labelling systems. But his lesson is strained because biological labelling patterns *are* highly correlated across cultures. Whereas biological groups are organized into ranked taxonomies, artifacts are not (e.g., there is no categorical boundary that determines where "cup" leaves off and "mug" begins), and the classification of artifacts involves a subtle (possibly domain-specific) interplay of functional and perceptual criteria (Miller 1978).

**Maffie** also allows that folk biology is universal, but says universality is not conclusive of innateness, much less of the "just-so story" of natural selection. Against the hypothesis of natural selection, Maffie argues that either there is enough structure in the world to do away with the need to have the mind create structure, or there is too little structure in the world for the mind to have evolved to selectively attend to it. Furthermore, without detailed historical information concerning the kind and degree of variation in ancestral populations, as well as specific information on gene flow and demographic structure, all evolutionary speculation is idle.

*Response:* The claim is not that universality entails innateness. There may be a host of cognitive or cultural universals, such as symbolism and stereotyping (see response to **Hunn**) that have none of the character of fine-tuned adaptations produced by natural selection. The argument for innateness involves converging evidence from processing, cultural transmission, acquisition, and pathology. As far as the structure of the world is concerned, stimuli do not come with little flags announcing their structural identity. Logically, the world of stimuli (the only world we are in direct contact with) is a flux of infinitely many associations that no structurally unbiased processing device could ever hope to order in finite time (Goodman 1965). Again, the empirical question is whether we have one general perceptually based similarity metric (built on some innate quality space of a priori phenomenal associations, see Quine 1960) or something more. There are numerous convergent empirical findings that test proposals for domain-general mechanisms (exemplar-based models of categorization, similarity-based models of categorical reasoning, characteristic feature models, other perceptually based models, etc.). All fail to account for experimentally reliable findings concerning folk biology (essence-based homogeneity of taxonomic categories, rank privilege in patterns of taxonomic inference, reliance on nonobvious characters, etc.).

To be sure, generic species are often locally self-structuring entities that are reproductively and ecologically isolated from other generic species through natural selection. But there is no a priori reason for the mind always to focus on categorizing and relating species *qua* species, unless doing so served some adaptive function. And the adaptive functions of organisms rarely, if ever, evolve or operate in nature as all-purpose mechanisms. Natural selection basically accounts only for the appearance of complexly well structured biological traits that are designed to perform important functional tasks of adaptive benefit to organisms (Pinker & Bloom 1990). In general, naturally selected adaptations are structures functionally "perfected for any given habit" (Darwin 1883, p. 140), having "very much the appearance of design by an intelligent designer . . . on which the wellbeing and very existence of the organism depends" (Wallace 1901, p. 138).

Although knowledge of variation and drift in ancestral populations is certainly desirable, it may be elusive for some time (perhaps always). In such cases, evolutionary biologists working with incomplete fossil records ask engineering questions about the possible organic functions of a given biological structure. By exploring how functional aspects of biologically determined human cognition evolved, insights are gained into the present nature of cognition. Functional explanations lead to evolutionary hypotheses which, in turn, often lead to a rethinking of function (see response to **Todd & López**). In short, although detailed and specific population data is highly desirable, functional inquiry in the context of evolutionary theory can proceed successfully without it.

**Solomon** grants that folk biology may be structured on particular universal and innate principles, but questions whether such principles are specific to the domain of folk biology. His arguments are similar to those of Keil (1995) and Gelman and Hirschfeld (in press), who believe that essentialism is an (innate) “mode of construal” that humans can apply to a number of domains (biological kinds, persons, social groups, inert substances). Teleology is perhaps another “mode of reasoning” (Solomon’s term) that can be applied to various domains (biological kinds, persons, artifacts). There are good arguments favoring a multidomain notion of essentialism, such as reliance on nonobvious properties in categorization and induction, and assumption of underlying causality.

*Response:* The form of essentialism that results for each domain is quite distinct (e.g., essences applied to persons distinguish individuals, whereas essences applied to biological kinds individuate generic species). Moreover, the idea of functionally unhinged modes of construal that evolved as free-floating principles, independent of the stimulus domains to which they eventually apply, seems implausible from an evolutionary standpoint (see my comments on Keil 1995). In no organism do naturally selected adaptations appear to lead to general-purpose organs or functional devices, and multipurpose modes of construal also seem to lack the perfect fit to habit that is the hallmark of naturally selected adaptations. It is possible that modes of construal are evolutionary by-products or accidents, although there is no evidence or reasoned argument to favor this position. **Solomon** graciously suggests that I am to be commended for demonstrating the preferential role of generic species in folk biological induction; however, much of the credit goes to Doug Medin, who first conceived of an empirical demonstration, and John Coley, who first implemented it.

#### **R4. Essence, rank, and domain-specificity: Possible but problematic**

**Hays** argues that the data from cultures around the world are still too spotty to support some general claims I make. He wonders how I can use naïve physics as another example of domain specificity and still claim that artifacts are not like living kinds because both rely on naïve physics. Beliefs about species transformation also undermine claims for enduring essences.

*Response:* Although I agree that having more cases would be preferable, two highly diverse cases should suffice to generate plausible hypotheses that further cases can then test and disprove to incite new hypotheses. Suppose a biol-

ogist were to find DNA or some other interesting biological property in some species of algae known to exist only in the Amazon River and Yaks known only to exist the Himalayas. The property’s presence in these two species alone would warrant the hypothesis that it is present in all organisms – certainly more so than if it were initially found only in similar groups of Amazon algae (this is analogous to most cognitive psychological studies, which are almost entirely focused on American or other urbanized college students).

The hypothesis that a cognitive structure found among rainforest Maya and Midwestern Americans is probably present in all humans is intermittently supported by work among a host of other cultures (including **Hays’s** work with the Ndumba of New Guinea). Unfortunately, as Hays signals, there is scant developmental data for nonurbanized societies (although we are presently analyzing data recently collected with American, Yukatek Maya, and Itzaj Maya children and adults). However, the little data there is on children’s taxonomies (Stross 1973) and biological essentialism (see Keil 1989) in the developing world seem to confirm findings for children in the developed world (e.g., Dougherty 1979; Hatano & Inagaki, in press) that support the account I present.

Granted, naïve physics serves as input to both understanding artifacts and folk biology (and is one reason folk biology is not informationally encapsulated). Beyond that, artifacts and living kinds may have too little in common to suggest a merging of the two domains. Finally, one reason the apparent violations of species identities are so striking both to the ethnographer and to the people studied is surely that such metamorphoses blatantly violate universal expectations about organisms (that each is uniquely assigned to a generic species by virtue of an underlying nature).

#### **R5. Generic species and rank, yes; a life-form rank, no**

**Thompson** argues that my own evidence undermines claims for taxonomy above the generic-species level. The emphasis is on Itzaj “horror” of life forms in the first series of (rank induction) studies rather than in the second (on category-based induction at intermediate levels).

*Response:* Like the Americans, Itzaj overwhelmingly prefer the lower taxonomic levels for induction; however, Itzaj exhibit much less secondary preference for life forms than do Americans. Nevertheless, several different experiments, including those reported in the target article, show that Itzaj do significantly rely on life forms in rank induction tasks ( $F[2,28] = 3.86$ ,  $MSE = 0.19$ ,  $p < .05$ , Coley et al. 1997, p. 84; and see regression tables in Atran et al. 1997, p. 32). Itzaj use of descriptive phrases for some life forms (rather than simple words) does not seem to indicate categorical vagueness, as **Thompson** implies. For example, sorting tasks involving both herpetofauna (“slithering animals”) and mammals (“walking animals”) produce only one overlap: the otter is always sorted with the mammals but is also occasionally allied with crocodiles as large water animals (Atran, in press), just as a bat is always sorted with birds and called a bird (*ch’üich’*, a simple word), but is also occasionally allied by morphology with rats and shrews (López et al. 1997).

Given such apparently ambiguous life-form affiliations, as well as the presence of generic species unaffiliated with

any life form, does not the inclusion of life forms in a ranked taxonomy “seem a rather mechanical assimilation, founded . . . on a covert imputation of aims to those of modern systematics?” Although the induction studies indicate that life forms do function as ranked taxa for induction in any culture in which they appear, it is an open empirical question whether they are mandatory and fully partition local biodiversity (see response to **Morton**, proposition 4.1).

### **R6. Anthropological evidence: Generic species, yes; rank and domain-specificity, no**

**Hunn** argues that life forms do not constitute a rank. More like intermediates, life forms are “a motley crew of categories grounded in whatever association is handy.” In support, he argues that Itzaj Maya failure to reason in accordance with taxonomic diversity reflects a lack of “consistent principles of inductive inference” applied at the life-form level. This motley and noninferential character of life forms resembles classifications of artifacts and persons, which argues against any domain-specific biological competence. Furthermore, a domain-specific account of folk biology is incompatible with anthropological accounts of animism or experiments in developmental psychology on children’s construction of racial essences, and will cause us to miss the intriguing connections between biological cognition, ethnic stereotyping, and anthropomorphism.

*Response:* **Hunn** misinterprets the findings on diversity-based inference. Itzaj inference is not inconsistent; rather, Itzaj appear to use consistent principles of inductive inference that involve causal (ecological) as well as purely categorical (taxonomic) assumptions. In our culture, various groups of ecological experts, as well as taxonomic scientists and even American college students (when able to justify their reasoning), also appear to employ reliably the causal reasoning strategies that involve life forms within a taxonomic context, and which diverge from diversity-based inference in ways similar to Itzaj strategies (Coley et al., in press; Medin et al. 1997). Hunn’s objection also implies that in testing for diversity within generic species (versus within life forms) both Maya and Americans should perform close to ceiling. I would not bet on it, but we should do the experiment.

Far from ignoring animism and anthropomorphism, a domain-specific account of folk biology may lead to a better understanding of such phenomena (Atran 1990, pp. 73–78; 1995b, pp. 222–28). I have argued that developmentally, the personification of animal kinds and the essentialization of human kinds involve a metarepresentational transference (Sperber 1985) between ontological domains that are conceptually “adjacent” (Keil 1979; Sommers 1950). Although people may be endowed with distinct intuitive ontologies, they need to integrate and adapt them to the actual conditions of individual experience and cultural life. Humans are cognitively resourceful and eclectic and will tend to use whatever is readily available to make better sense of the world. In the initial absence of causal knowledge about (usually furtive) animals, analogies to humans may lead to useful and accurate predictions about entities phylogenetically similar to humans (Inagaki & Hatano 1991). Children may also transfer insights from ontologically more distant domains, such as naïve mechanics, to close the knowledge gap initially with respect to living kinds (Au & Romo, in press).

For mature adults who know a lot about animal behavior and processes, anthropomorphic projections of folk psychology onto animals (and to a reliably decreasing degree on plants, artifacts, and substances, Kelly & Keil 1985) do not so much aim to give a mentalistic account of animal behavior as to violate expressly intuitive expectations of a categorical difference between humans and animals. Such express violations of adjacent intuitive ontologies, “automatically” grab people’s attention and incite minds to build infinitely many (nondeterministic) inferences and connections between neighboring domains. This is a central and recurrent process in the formation of cultural symbolism (e.g., religion, myth, fiction) throughout history and around the world (Boyer 1994a). In this respect, animistic representations that form part of cultural lore may actually be less prevalent among the children of a culture than among the adults (Mead 1932). Racism and stereotyping, which involve the attribution or projection of biological essences or enduring dispositions to social categories, create stable human kinds that are otherwise not firmly preestablished by nature or the mind.

Anthropomorphism, animism, racism, and stereotyping may well be examples of cultural universals that emerged as evolutionary by-products rather than as direct, naturally selected adaptations of human cognition. Still, the cultural selection of such apparently universal cognitive traits as symbolism and stereotyping may also be compatible with and dependent on mechanisms evolved as adaptation, but with any added advantage now transmitted across generations “semantically,” that is, through cultures instead of genes. For example, symbolism (violation and inferencing across intuitive ontologies) allows various sorts of information to be accommodated to different situations in a more flexible (apparently contradictory, open-textured format) than does a strictly rational device bound by consistency, verifiability and so forth. (Alternatively, symbolism and stereotyping may be nonadaptive evolutionary by-products, or “diseases of the mind,” in the way that catching common colds is an evolutionary by-product of the respiratory system.)

As with religious symbolism, the cultural omnipresence of racism (Hirschfeld 1996) and reciprocity (Lévi-Strauss 1969) may also reflect an evolutionary component. Homiids have evolved in environments in which social relationships with conspecifics may be considered the overwhelming determinant in natural selection (Alexander 1989). If so, the selection of cognitive mechanisms favoring cooperation among competing conspecifics would be a paramount factor in survival and selective reproduction (Axelrod & Hamilton 1981). The primary biological mechanisms favoring cooperation include kin-selection (a function of the cost of helping someone and the genetic distance between helper and beneficiary, Hamilton 1964) and reciprocity (a function of the cost of helping nonkin and the probability of receiving future help from the beneficiary or the beneficiary’s kin, Trivers 1971). Racism (the biological essentialization of social groups) may favor the appreciation of minor physical differences as separating kin from others. Stereotyping (the attribution of enduring social dispositions to individuals) may help establish reliable conditions among nonkin for in-group reciprocity and exchange, and for the detection of potential free riders to cheaters as more likely to belong to the out-groups. Thus, by artifactually reducing the natural variation among individuals, humans could cre-

ate reliable conditions for deciding whom to trust (Norenzayan 1997). Once decided – however arbitrarily or conventionally – a causally efficacious “looping effect would set in between people’s expectation of in-group versus out-group behavior and actual behaviors induced by such expectations (Hacking 1995).

**Ellen** presents objections that are by and large the same as those of **Humm**. In addition, Ellen objects to a “unified theory” of folk biology, although I imply in the target article (sect. 3.4) that any claim about folk theory is either false or too vague to assess (see response to **Johnson**). He contends that cross-cultural regularities in the structuring of living kinds do not arise “because of obvious features of the mind that does the classifying, but because of regularities in the objective world” (see responses to **Livingston** and **Maffie**). Ellen also objects to my treatment of folk biology as a unitary core meme rather than as (part of) a developing meme (see responses to **Aunger**, **Sperber**, and **Boyer**). He argues that “empirical ethnographic reality . . . allows for particular ‘classifications’ depending on context” and that claims of universal, general-purpose taxonomy involve deleting features that do not fit the expected pattern of peoples’ classifying behavior “until such a pattern is obtained.”

*Response:* **Ellen** rightly notes that the “‘kind of’ relationship that links ranks is ruthlessly binary” (see response to **Morton**, proposition 1), but he asserts that for the Nu-aulu of Indonesia “it is difficult to infer a permanently-encoded rank order from a string of transitive relationships.” Yet, it is partly to relieve ethnographers of having to rely exclusively on their intuitions to infer taxonomies that I originally proposed combining sorting and induction experiments to test for regularities in categorization and reasoning within and across ranks.

**MacLaury** raises three objections: Why introduce a new term “generic species,” when “generic” and “folk species” are already in use? Although folk-taxonomic universals are well documented, why claim that the responsible mechanisms are domain-specific and not equally applicable to artifacts? As with the Berlin and Kay’s (1969) work on color, positing modular and crisp categorical relations “contradicts anthropological fact, substitutes theory with mind-machine metaphor,” and if allowed to be pursued as a research program, “may perpetuate the bias in field work.”

*Response:* I introduced the term “generic species” to eliminate conceptual confusion and combine earlier convenience with greater historical accuracy and wider practicality. Ethnobiologists and historians of systematics (as well as working biologists) mostly agree “that species come to be tolerably well defined objects . . . in any one region and at any one time” (Darwin 1883, pp. 137–38) and that such local species of the common man are the heart of any natural system of biological classification (Wallace 1901, p. 1, cf. Mayr 1982). But whereas zoologists and ethnozoologists generally refer to such common groups as species (or “speciemes”) in focusing on behavior, botanists and ethnobotanists refer to them as genera (or “generics”) in focusing on morphology. As working concepts, either alone is likely to be more confusing for historians of systematics than “generic species,” as when the zoologist George Gaylord Simpson declared that the hallmarks of priority attributed by some of his colleagues to the genus “are characteristic of the . . . species, not genus” (Simpson 1961, p. 189). Historically, the original genus concept was justified in

terms of initially monotypic generic European species to which other species around the world might be attached (Tournefort 1694).

The claim that folk biological universals are domain-specific rests in part on two sets of observations denied by **MacLaury**: (a) Nothing akin to the ranking of essential kinds applies to other domains, such as artifacts, and (b) currently testable domain-general models of similarity fail to account for the priority of generic species in cultures, such as our own, where perceptual experience favors use and recognition of taxa other than generic species.

I do not see how entertaining the hypothesis of clearly structured folk-biological universals will bias fieldwork and hinder understanding of biological relationships that do not fit the putative universal pattern. Surely, relations posited as crisp and clear are easier to evaluate scientifically (and to show to be wrong) than relations posited to be fuzzy and vague, even if the latter are ultimately true. Concerning folk biology, the ability to nail down the universal component has allowed us to discover and explore dramatic cultural differences with a more pointed and subtle understanding than would have been the case otherwise. For example, we have found that three populations exploiting the same common environment have highly similar biological taxonomies with more or less equivalent content: Itzaj Maya, Q’eqchi’ Maya, and Ladinos. However, despite extensionally comparable appreciations of the organic world, the three populations differ remarkably in their appreciation of ecological relations between humans, animal generic species, and plant generic species. These reliable cognitive differences in what we call “folk ecology” are highly correlated with, and perhaps causally constitutive of, strikingly different behaviors that sustain (Itzaj Maya), destroy (Q’eqchi’ Maya), or variably affect (Ladinos) in the rainforest (Atran et al., under review).

## R7. Psychological evidence and the “theory theory”

**Matan & Strauss**, like **Maffie**, believe that I argue in-nateness from universality, and further contend that I ignore the developmental literature that speaks against in-nateness. They cite Carey’s (1985) study purporting to show that children use folk psychology to construct a biological theory of living kinds that eventually includes plants with animals as alive. Only by age 10 are children able to interpret bodily functioning and growth in plants and animals without invoking intentional causes (e.g., growth as a physiological process vs. wanting to grow up to be strong). Before age 10, children supposedly lack a sufficiently developed notion of biological “theory” to produce a stable ontological category of living kinds that includes plants and animals. Matan & Strauss claim that artifacts, too, have essences, and that folk-biological rank is an “emergent property” of “a domain-general taxonomy-maker.”

*Response:* I have pointed out elsewhere inadequacies in Carey’s study (Atran 1987b; 1995b). More significantly, numerous recent developmental studies indicate a much earlier appearance of nonpsychological causal reasoning in folk biology for both animals and plants (4 years old at the latest) (e.g., Coley 1995; Gelman & Welman 1991; Hatano & Inagaki 1994; Hickling & Gelman 1995; Keil 1992; also see Wellman & Inagaki 1997 for a review and Carey’s 1996 re-

ply to me and other critics). Even earlier evidence for or against the role of folk psychology in folk biology is hard to come by and not presently decisive. However, the issue of whether fleshing out causal reasoning in folk biology involves early input from other domains, such as folk psychology or naïve physics, may have little bearing on the ontological coherence and taxonomic arrangement of living kinds.

Call whatever it takes to be an artifact what you will, but it would be absurd to induce by virtue of a presumption of underlying causality that a three-legged or legless (e.g., beanbag) chair is quadrupedal by nature because most chairs have four legs, or to examine a chair (e.g., under a microscope) to look for evidence of that missing nature. Although an artisan's intentions may persistently contribute to an artifact's definition despite it being put to other uses (e.g., a stool turned upside down for use as a waste paper basket may still be considered a stool), other uses can also enter into the definition to change the item's nature and identity (e.g., a vase used as a lamp is both a lamp and a vase). Physically identical items may have distinct "essences" (e.g., a wooden table and a wooden bed) and a given artifact may ambiguously belong to different inclusion series (e.g., wheelchairs are chairs, and chairs are furniture, but wheelchairs are not furniture). Finally, do **Matan & Strauss** have any idea of how, for example, the logical and presumptively causal relationship of rank that holds between nonhierarchically connected concepts, such as dog and lemon tree, emerges from unranked class hierarchies? I doubt it, but if so, let us hear about it.

**Johnson** argues that data from cognitive psychology indicates that plants are not initially subsumed with animals under a broader category of living things. Her arguments are those of Carey (1985): children initially interpret animals as being alive in psychological terms, but they do not extend this initial "theoretical" conception of life to plants. She sees me as suggesting "that the system of rank found within both animal and plant taxonomies derives from a universal teleo-vitalist causal construal of generic species." She then goes on to attribute this position to my reading of attempts in the developmental literature "to characterize children's earliest biological theories" as "vitalism."

*Response:* I have explained above and elsewhere (Atran 1995b) why personification of animal behavior need not imply that folk biology is initially part of folk psychology. Neither do I see how failure to apply personification analogies to plants entails that plants are not initially part of folk biology. **Johnson**, like Carey (also **Boyer, Ellen, Hampton, Hatano, Matan & Strauss**) equates folk biology with "intuitive" or "implicit theories," then goes on to examine how my position fares with respect to this theory-based notion of folk biology. Johnson has my claim exactly backward. I have indicated in the target article, and stated elsewhere, that: "Rather than theories making categories, it is the domain-specific structure of categories that severely constrains, and therefore renders possible, any theoretical (or culturally peculiar "cosmological") elaboration of them" (Atran 1994, p. 317). Johnson's findings that people with Williams syndrome preserve folk-biological taxonomies but lose causal appreciation of them would seem to support rather than undermine my claim. This claim for a domain-specific taxonomic structure centered on essence-based generic species antedates any reading of the developmental literature (e.g., Atran 1985a; 1985b; 1985c). By "vital-

ism," I mean only causal assumptions about underlying essence not reducible to mechanics or psychology.

Although I have tried to show how in the history of science actual theories were built up from folk biology, I do not pretend to understand the notions of intuitive, implicit, or folk theories of biology (or mind, physics, etc.). Such notions are mostly versions of what Morton (1980) originally dubbed the "theory theory" and first popularized in the developmental literature on "theory of mind" by Astington et al. (1988). [See also Gopnik: "How Do We Know Our Minds" and Goldman: "The Psychology of Folk Psychology" *BBS* 16(1) 1993.] It has since extended to much of the developmental work on domain specificity (Hirschfeld & Gelman 1994). The general idea seems to be that domain-specific competences are more like explanatory theories than skills and involve networks of conceptual generalizations to best interpret the behavioral patterns observed in a given domain. These knowledge structures may be a diverse in organization and content as there are domains and acquisition stages for a domain. So far, not a single testable principle has been proposed that would allow someone to decide whether or not such knowledge structures are theories. In the target article, I propose three criteria (integration, competition, effectiveness) because psychologists have rejected any number of other criteria as decisive (e.g., empirical verifiability or refutability, logical consistency or global coherence, etc.).

Dan Osherson (1997) has recently suggested another test for determining what is or is not a theory, using the diversity principle as a criterion for sampling evidence in a way that conforms to scientific (Bayesian) intuition. My bet is that most children and ordinary folk would violate such a principle, as they may do when they reject diversity-based reasoning in biological inference. I also expect that adherents of the "theory theory" will simply ignore any findings that emerge as too explicit, restrictive or whatever. In sum, current notions of child or folk theories seem to be either hopelessly vague or likely to be evidently false.

**Hatano** agrees that humans are endowed with domain-specific constraints for acquiring folk biology, but doubts the living-kind module promptly produces universal folk taxonomy. He notes that young children have very limited taxonomies and may rely more on personification analogies than taxonomic inference to expand knowledge initially in the face of uncertainty. Children are also not prepared to classify entities at the rank of generic species. He questions whether the rank induction studies show that American students prefer generic species for making biological inference because experimental materials were selected on linguistic grounds and because different properties may privilege induction at different ranks (e.g., if told that sparrows have thin bones, people may project the property to all flying birds rather than to all birds).

*Response:* Studies show that American, Japanese, and Maya children use personification analogies: however, even 2-year-olds may use category-based induction that involves minimal taxonomic understanding (e.g., a dodo is a kind of bird, Gelman & Coley 1990). The only evidence I am aware of for **Hatano's** claim that children under 2 years of age do not classify at the generic-species level is work by Mandler and her associates using plastic tokens as stimuli, and showing failure to categorize at Rosch's basic level consistently (e.g., Mandler et al. 1991). Such experiments are hardly conclusive because of the confound between generic

species and basic-level categories and the absence of relevant real world stimuli.

As for the rank induction tasks, an unmistakable and overwhelming preference for induction at the generic-species level has been experimentally replicated under a variety of linguistic conditions (e.g., tree, apple tree, winesap apple tree; tree, apple, winesap) using a variety of properties (e.g., “has an enzyme,” “has a protein,” “has a disease,” or simply “has a property *x*”). Granted, some properties can mobilize actual knowledge about those properties (e.g., the relationship between thin bones and wings) and favor inferences to intermediate taxa or even to cross taxonomic groups (e.g., flying birds and bats); however, this is equally true of Itzaj, for whom **Hatano** seems to accept inductive preference at the generic-species level. Moreover, it is precisely with respect to properties that have little, if any, associated content that a “pure” test of category-based induction and the role of taxonomic ranks is meaningful. Although no property may ever be truly “blank” (such that induction depends on the category alone and not on any previous knowledge of the property in question), we choose properties that are as empty as possible but can still be associated with assumptions about underlying biology.

There is no disagreement with **Hatano’s** comments on personification, and on the processes whereby children come to understand concrete or specific pieces of knowledge about living kinds. His work (in collaboration with Inagaki’s) on these issues continues to advance our understanding of the specific character and development of the folk-biological domain within and across cultures.

**Hampton**, too, has doubts about the rank induction experiment. He suggests that choosing comparable properties in different cultures may bias results to reflect induction patterns for those properties rather than for biological properties in general. Hampton also draws out the implications of the target article for the doctrine of externalism (the belief that the real definition of *bird* involves commitment to a nomological account of the avian concept and deference to scientific expertise).

*Response:* Finding comparable properties was much more of a problem with the Itzaj than with Americans, but the induction patterns of the Itzaj are considered least problematic and what most ethnobiologists would have predicted. The surprising results concern the Americans, for whom the range of properties and conditions tested are much wider. Here the results are strikingly robust.

**Hampton** makes the incisive points that externalism (Fodor 1994; Kripke 1972; Putnam 1975) should not be confounded with psychological essentialism (Atran 1987b; Medin & Ortony 1989), that is, with the belief that folk-biological kinds possess underlying essences and that such essences may be in part guides and “place holders” for deeper causal knowledge. Only to the extent that scientific knowledge is compatible with intuitive ontology can it be incorporated directly into folk biology. Otherwise, folk and scientific knowledge remain cognitively segregated.

## R8. Folk biology as a functional physiological adaptation: Evidence and speculation

**Roberts** cites evidence from ethology for categorization (recognition) of living kinds among other species, and evidence from primate studies suggesting a capacity for ostension

(pointing) by captive great apes. Given this rudimentary ability to categorize living kinds and perhaps communicate about them, he goes on to speculate about refinements in hominid cognition that may account for why humans alone are capable of full-fledged taxonomies.

*Response:* Another hallmark of adaptation is a phylogenetic history that extends beyond the species in which the adaptation is perfected. For example, ducklings crouching in the presence of hawks, but not other kinds of birds, suggests dedicated mechanisms for something like species recognition. The studies **Roberts** cites reinforce the idea that folk biology in humans may be an adaptation. However, despite some intriguing suggestions about differences that emerged between hominids and other primates, I do not understand enough of his ideas (e.g., “recursion . . . between domains” or “logico-mathematical cognition” in chimpanzees) to evaluate them. His proposals are well taken for ontogenetic research using sorting tasks and match-to-sample paradigms involving gaze duration to address the development of relationships between categorization and ostension.

**Todd & López** try to understand why humans and other species might have triggering algorithms that favor recognition of individual conspecifics and different algorithms that favor immediate recognition of the individuals of another species as members of that species rather than as individuals as such. They argue that all organisms must function to procure energy to survive, and they must also procure (genetic) information for recombination and reproduction. The first requirement is primarily satisfied by other species, and an indiscriminate use of any individual of the other species (e.g., energy-wise, it does not in general matter which chicken or spinach plant you eat). The second requirement is usually only satisfied by genetic information unique to individual conspecifics (e.g., genetically, it matters who is chosen as a mate and who is considered kin). They also show experimentally how spatio-temporal cues could trigger domain-specific mechanisms for species-level recognition. Such mechanisms are fast and cheap, using the minimum information necessary. As a result, there may be false alarms (e.g., a frog responding to a moving black dot as if it were a fly, a child thinking fast-moving clouds may be alive, etc.), although these are probably lower-cost mistakes “than missing the cues of animacy of real organisms in the environment.”

*Response:* **Todd & López** provide a fine example of how functional explanation and evolutionary hypotheses can be mutually informative.

**Job & Surian** provide evidence from pathology indicating selective cerebral impairments of folk-biological taxonomies, and portions of those taxonomies. Neuropsychological studies have often reported a pathological performance in recognition at the life-form and generic-species levels (e.g., recognizing an item as an animal but not as a bird or robin), and dissociation at the life-form level (e.g., not recognizing items as trees). But existing studies do not say anything about the generic-species rank as the preferred level of representation for reasoning. Job & Surian speculate that this may be because of methodological concerns (linked to averaging over items and failure to include sets of generic species) and because neuropsychologists have not looked for the relevant data (which the target article suggests may be more related to reasoning than to identification). They also note (personal communication, January 1998) that identification and reasoning may be dissociated at the generic-

species level. For example, one patient was able to describe cows as eating grass but unable to provide the label “cow” (giving instead a coordinate, such as “giraffe,” or the kingdom label “animal”). Job & Surian propose that studies be undertaken to clear up these issues.

*Response:* These comments suggest to me that the target article, by setting abstract conditions on the kinds of structures neuropsychologists might profitably look for, favors a research strategy that may be somewhat less haphazard than attempts at direct assessment of the cognitive consequences of this or that brain trauma.

## R9. The evolutionary character of folk biology: Problems with memes

**Aunger** argues against any principled distinction between developing and core memes for three reasons: (1) Core memes may be larger and more complex than developing memes (e.g., it is simpler to design chess-playing robots than robots that have functional conceptions of biology, psychology, or naïve physics); (2) core and developing memes are phenotypically alike and thus equally “semantic” (e.g., both can emerge in a public utterance: “that’s a vulture” vs. “my totem is a vulture”); and (3) transmission chains need not be shorter for core memes (e.g., the serial conveyance of “oak” through a population by ostension or description may be far more extended than having everyone read about a fact in a newspaper or scientific journal).

*Response:* These points are unpersuasive: (1) Because all developing memes implicate core memes but not vice versa, developing memes are invariably “larger and more complex” than core memes. Humans, unlike computers, ordinarily acquire knowledge of chess *by virtue of* prior knowledge of objects and intentions. Similarly, knowledge of totems is always built on knowledge of generic species, but knowledge of generic species (e.g., in our culture) need never involve knowledge of totems. (2) Although both core and developing memes are conveyed publicly, and may have numerous and variable mental and public representations as ascendants and descendants, core memes also regularly involve a universally identifiable, structurally stable iteration across behaviors and minds (e.g., ostensions and utterances of “oak” – whatever else they may lead to – trigger the activation and quasi-replication of taxonomic segments involving the concept *oak*). (3) Many people may read from a scientific or liturgical document, but highly intricate and necessarily contingent historical and sociological chains underlie the infrastructure of science or religion. In contrast, the triggering of taxonomic knowledge involves little contingent sequencing of public behavior (it hardly matters when, under what conditions, or from whom one hears about “oaks”).

**Sperber** objects to the very idea of a replicating “meme” to describe cultural transmission of information. In culture, genuine replication is vanishingly rare. When it occurs (e.g., in chain letters, giving telephone numbers), they are not very informative about culture. The importance of a cultural representation resides not in the number of copies in the environment but in their effect on people’s minds. Instead of talking about evolution in terms of replication or reproduction, it would be better to think of the regular and recurrent development of cultural knowledge in terms of a convergent production of representations toward some

“psychologically attractive type,” where “attraction” refers metaphorically to some (mathematically) optimal space of ecological possibilities (Sperber 1996b, pp. 106–18; see Axelrod 1995 for a related modeling of cultural evolution). Sperber points to the existence of experts, and to the fact that experts often disagree, as indicating that the stability of folk-biological taxonomies “is not an effect of ‘high-fidelity copying,’ but of the fact that most ‘failure of copying’ results in mere lacunae rather than divergences.”

*Response:* The existence of expert folk biologists may be no more indicative of lacunae in folk-biological competence than the existence of expert linguists and stylists are indicative of lacunae in linguistic competence among ordinary folk. The specialized knowledge of experts (and not just the divergences between experts) may be only a marginal factor in a consensual cultural model. For example, Boster and Johnson (1989) found that expert and nonexpert fishermen shared a strong cultural consensus in their fish classification (i.e., a single factor solution, reflecting high inter-informant agreement and high individual competence). But expert fishermen diverged more in knowledge from one another, and from nonexperts, than did nonexperts from one another. Experts also diverged more from scientific classification than did not nonexperts. Thus, expertise may be idiosyncratic, with little bearing on the processes that result in a cultural consensus.

Nevertheless, I agree with **Sperber** that a stimulus-driven model of replication captures neither the creative psychological processes nor the ecological variability involved in the cultural transmission and selection of representations. Of course, at some level, talk of replication can always be made acceptable. Thus, it is trivially true that when one set of representations causally triggers an entirely different set of representations, the notion of “representation” is replicated. But this sense of replication has no interesting causal story to play in our understanding of how some representations become culturally widespread in a population whereas others do not. Still, although not primarily replication, there are domain-specific constraints on the processing of stimuli that involve aspects of replication and that characterize core representations of culture, such as folk-biological taxonomy, as opposed to developing representations, such as totemism of evolutionary science.

Consider as an illustration what happens when someone points to a tree and says “oak” with the intention of getting another person to notice that he has an oak in mind. The second person might acknowledge the first person’s intention by repeating the word “oak.” Assume the two communicators have a (universal) folk psychology that allows them to infer intention spontaneously from the association of a phonetic signal to pointing. If my account of folk biology is near the mark, understanding the first person’s intention requires the second person to activate part of his (universal) taxonomy spontaneously and place a concept placeholder (including assumptions of underlying essence) for *oak* at the generic-species level. When the second person utters “oak” the first person will (re)activate part of his taxonomy with *oak* at the generic-species level.

This process looks something like replication. The word “oak” could be said to replicate publicly (if one discounts acoustic variation), and the concept *oak* to replicate across minds as a taxonomic placeholder that carries assumptions of underlying essence. This recurrence is quasi-automatic, and fundamentally determined by domain-specific cogni-

tive process. **Sperber** agrees that users of the word “oak” mentally represent it as a taxon of specific rank, denoting a kind with underlying essence. But he could argue rightly than even here replication is deficient.

First, it is not that the stimulus “oak” causes itself to replicate so much as that it triggers activation of a more or less rich, and largely prior, domain-specific cognitive structure. Second, neither the full nor partially activated taxonomies of people in ordinary communication are likely to overlap completely. For example, the first person may activate a partial taxonomy including (the life forms) *tree* and *grass* and (the generic species) *elm*, whereas the second person activates *tree*, *bush*, and *maple* to place *oak* in a taxonomically appropriate position. In the process of acquisition by children, substantial concordance between taxonomies is initially even less likely. Third, the referential content of *oak*, however, narrowly or broadly conceived, need never overlap completely among persons communicating in the culture. People might think more of actual exemplars than generalized types, or more of characteristic trunk structure than leaf structure (or vice versa). But the mind conspires with the world to constrain mutual understanding to a highly manageable degree. The oaks that are actually tokened or described in the environment attract people’s attention, triggering and empirically focusing the a priori assumptions of essential kindhood that lead to cultural convergence on the meaning and reference of living kind terms. People who assume that all oaks are essentially alike can readily find a variety of perceptual indicators or token descriptions drawn from the environment to substantiate that assumption one way or another. This conspiracy between mind and world may be a design of natural selection.

The distinction between core and developing memes was intended to represent the insight that some sets of (intradomain) representations are more directly a product of our species-specific cognitive endowment than others. These core representations also have highly stable and privileged roles to play in the production, development, transmission, and recurrence of more complex sets of (interdomain) representations, both within and across cultures. In the current state of metaphorical imprecision, one could just as well cast the relevant distinction as being between “core producers” versus “developing producers.” Whereas “meme” highlights the relatively stable and recurrent aspects of core versus developing processes, “producer” highlights the highly creative and relatively variable aspects of culturally identifiable representations as opposed to genes.

**Boyer** follows **Sperber’s** view of cultural evolution but is more generous in allowing that the distinction between core and developing memes may be “adequate for the domain at hand [folk biology] but needs some modification to apply to other domains of culture.” He recommends greater attention to acquisition processes that build cultural representations on the basis of prior conceptual structures, “among them an *evolved intuitive ontology*” involving “implicit theories.” He also implies that the distinction between core and developing memes fails to take into account “causal dependencies between different types of cultural acquisition”: enrichment of intuitive ontology (e.g., folk-biological expertise), the simultaneous violation of ontological principles and activation of all remaining and relevant nonviolated principles (e.g., animal symbolism), and metarepresentational displacement and institutionalization of ontologies (e.g., scientific biology).

*Response:* Except for the idea that core representations involve “implicit theory” – a notion I find confused – there is little to distinguish **Boyer’s** position from mine. I agree that the transmission of different aspects of a cultural system can involve different “cognitive inheritance tracks,” as in the recurrent violation and inferential use of multiple functional ontologies (e.g., folk biology, folk psychology, naïve physics) to build religious systems the world over. Boyer has probably done more than anyone else to show how this process works for religion. But the emergence of any given science may also involve violation and inferencing across intuitive ontologies. At any given historical moment, scientific and symbolic speculation may start from the same analogies or ontological violations (e.g., life as mechanism, plants as upturned animals, the microcosm as a reflection of the microcosm, etc.). In sum, both science and symbolism can be characterized by developing memes that emerge along multiple “cognitive inheritance tracks.”

I have argued elsewhere that despite similar beginnings, there may be fundamental differences between how religion and science subsequently treat information and ultimately reconstrue our ontologies of the world, and how they activate and constrain inferencing across ontological domains (Atran 1990; 1996; cf. Atran & Sperber 1991). For example, scientific discourse often aims to kill the metaphor in the analogy by reducing it to a lawful description and platitude (e.g., solar systems and atoms are governed by the same mathematical laws), whereas religious discourse better endures by leaving such metaphors open to interpretations that can be fit to a variety of situations (e.g., God rules the universe as he does our hearts and bodies).

It is the emotional commitment, however, that religious metarepresentation elicits – rather than representational structure as such – that seems to make these developing memes such potent and resistant invaders of minds and cultures. Whereas the meaning and reference attached to the proposition “the cat is on the mat” is fairly transparent and carries little if any identifiable emotional commitment across individuals in a culture, “God is on the mat” is more likely to evoke perplexity and awe. In general, people would be more willing to stake life on some veridical exegesis of the second type of utterance than the first. Why is it that life-focusing emotions tend to attach to the peculiar types of metarepresentations that characterize symbolic rather than rational discourse? Without an answer, I see no way in principle to distinguish **Sperber’s** and **Boyer’s** accounts (or my own previous accounts) of symbolism from the mere fantasy of, say Mickey Mouse cartoons.

*Inter alia*, emotions are biologically evolved devices that coax us to adaptive behavior by sustaining attention, focusing and enriching cognitions, and determining the value of things (e.g., producing different exchange values among otherwise extensionally equivalent items: a given house is usually worth more to someone if it is an ancestral home). This critical but insufficiently-studied alliance of life-sustaining emotions to meta-representational violations of adjacent intuitive ontologies allows minds to connect and explore rationally incompatible bits of information to cope with awareness of the inexplicable or unknown (including awareness of life and death). Philosophers and theologians have long realized that neither rational nor empirical principles alone can demonstrate the existence of the self or of the world as a totality. Mutually constituting such beliefs through emotive symbolic



constructions may be a by-product of biological evolution that has become a primary function of cultural evolution.

### R10. Is science continuous with common sense?

**Ghiselin** doubts that scientists (and philosophers of science) have given up on species as classes, natural kinds, or essences (see also Hull 1991). He suggests that the ontological distinction I claim that folk make between plant and animal cuts too deep, and that such a categorical distinction may reflect more a confusion “in the minds of students of folk classification” than in the minds of the folk studied. He argues that there may be more continuity between folk and scientific notions of classes, essences, and logical individuals than I credit. For example, people can simultaneously conceive of part-whole and class relationships with respect to the organic world (body parts, families, etc.). Ghiselin is also bothered by my emphasis on induction as the basis of classification, sensing a throwback to the naïve inductionism (I suppose) of empiricism and logical positivism.

*Response:* **Ghiselin** offers no evidence that ordinary folk blur the ontological distinction between plant and animal. Indeed, as **Johnson** argues, the psychological evidence may suggest an even more radical cognitive distinction between plants and animals than I have proposed. Humans everywhere conceive of part-whole relationships, classes, and a host of other things; there is no evidence, however, that people generally think of generic species as logical individuals or family parts, rather than as an extension of individuated objects sharing an underlying causal nature. The insight that species are individuals required the intellectual effort of evolutionary theory, and the further analytic advance made by Ghiselin himself. Humans everywhere are also able to think of number and space, but only in the West was science born of allying number to space.

**Ghiselin's** conjecture that folk taxonomies may be the product of a more “general-purpose” adaptation that includes folk anatomies, folk sociologies, and other things would gain support if one could deduce the structures of folk anatomies or folk sociologies from all and only those structural principles of folk biological taxonomy. But there is nothing akin to rank in any folk anatomy I am aware of (and it must be present everywhere). Although a sort of ranking characterizes some social formation (e.g., armies) it is not universal, nor are the contents of any such ranking invariably assumed to be essentially constituted by nature as a kind (rather than as a collection of parts, individuals, etc.). Finally, replace “induction” with “etiologically-based inference” and nothing else in my account would be different. The finding that similarity-based induction fails to capture most aspects of folk (or scientific) taxonomy should be congenial to Ghiselin's aversion to inductionism.

**Stevens** like **Hatano** and **Hampton**, questions the rank induction experiment. He implies that I ignore differences in rank induction patterns between Americans and Maya because they do not fit my hypothesis about inductive preference for generic species. He notes the historical difficulty for Western systematics (or children and ordinary adults) in specifying a definition of life, or a diagnostic distinction between plants and animals. He claims that college students, like natural historians, often see various nonhierarchical relationships between groups. He cites Buffon and others who posited a continuity between groups of organisms that

accords with how “the bulk of mankind” reasons. Stevens also asks what I could possibly mean by readily perceptible evolutionary gaps as exemplified by the cacti, given that cacti can be grafted to plants of another family.

*Response:* The first two paragraphs in my discussion of the results on rank induction (sect. 1.2.2.3) deal with cultural differences: American college students have greater secondary reliance on life forms because in urbanized environments life forms is what the students most easily recognize and know from experience. Itzaj Maya have greater secondary reliance on folk specific because their silvicultural life depends on experience at that level. Despite the compelling needs established by life experience, both the Americans and Maya overwhelmingly, and in nearly equal measure, subordinate such influences to a preference for generic species.

The ability to specify folk-biological structure is not necessarily relevant to its exercise (just as a difficulty in specifying color boundaries or grammatical distinctions is not necessarily relevant to the perception of color or the grammatical use of language). People may sometimes think of continuous or linear relations between living kinds, but they also invariably see the same sorts of hierarchy. I have documented (Atran 1992) how Buffon labored decades to fit a tortured notion of continuity onto a (folk)biological hierarchy from which he never wavered.

An evolutionary gap, like an evolutionary taxonomy, reflects both genealogical and ecological (zone of adaptation) distance. Phenomenally, cacti are very peculiar plants, consisting only of stems with no leaves to speak of. This leafless aspect represents an unmistakably distinct adaptation to a dry environment. Recent analyses of structural morphology and molecular genetics have convinced many systematists (including **Stevens**) that cacti, which are American in origin, are genealogically related to the succulent South African carpetweeds (*Aizoaceae*) of the pink order (*Caryophyllales*, now including cacti). Thus, the evolutionary gap between the cacti and other plants may be less genealogically based than ecologically based: within any given locale there are usually no other plants that remotely resemble cacti in their morphology or molecular structure. Historically, the phenomenally peculiar and ecologically localized features of the cacti initially guided ideas of, and may still capture aspect of, its evolutionary status.

**Stevens** raises some additional points: (1) Working taxonomists rely more on keys than on inductive taxonomies to identify organisms. (2) Changing ideas of relationship may not change the kind involved, but it will change our knowledge about it. Thus, even if a taxon contains the same circumscription in a folk and evolutionary taxonomy, if the immediately adjacent taxa are different, then understanding that taxon will be different. (3) Why should Aristotle fail by trying to explain a familiar order of things with a limited sample? Agassiz was not bothered by limited sampling.

*Response:* (1) Some keys use features that have little apparent relationship to phylogeny (artificial keys), whereas other keys use characters designed to reflect phylogenetic relationships (natural keys). No matter how natural the key, however, it does not seem possible to make a single workable key to taxa of a given rank (e.g., families) in which each family keys out only once. Even in the best keys, families key out several times, whereas in a general classification, as in evolution, a family appears naturally only once. (2) It is true, for example, that when bats were put with mammals,

and cacti with *Caryophyllales*, understanding and predictions about bats and cacti changed. Nevertheless, it is knowledge about *bats* and *cacti* that *changed*, which seems different from the creation of a new kind, such as bacteria. (Admittedly, spelling out the difference is no easy task.) (3) In an earlier treatment (Atran 1985b), I showed how Aristotle sought to construct a taxonomy of analyzed entities, that is, entities whose essential properties could be exhaustively inventoried and then arrayed in logical sequence, somewhat like geometrical figures (e.g., geometrical figure, polygon, triangle, equilateral triangle, etc.). Aristotle believed he could discover the appropriate analytic (essential) characters by trial and error because he thought his inventory of generic species was virtually complete, with the new types sent back to Greece from Alexander's expeditions requiring only minor taxonomic adjustments. Aristotle did not realize there were orders of magnitude more types in the world than anybody at that time could have foreseen, and that his inventory was only a fragmentary expression of the earth's biodiversity. Agassiz, who had as much to work with as Darwin, may not have thought that sampling was all that relevant for discerning the natural order, but neither was he concerned with a taxonomy of analyzed entities.

### R11. Toward a causal science of anthropology

**Romney** proposes a set of statistical techniques for evaluating levels of interinformant agreement within and across cultures. Although his analysis of my data supports the idea of a universal appreciation of biological kinds, it is neutral as to whether this high degree of within- and between-culture consensus arises from the mind, the world, or both.

*Response:* **Romney's** techniques provide easily applicable and rigorous standards for assessing the relationships between individual and cultural variation (although background assumptions about underlying distributions may need more careful scrutiny). These techniques are well suited to an epidemiological account of culture because the spread of ideas within and across populations can be tracked statistically and cultures can thus be described (in part) as a causal distribution of ideas. For example, his methods can be readily used to explore issues of variation in knowledge among experts versus nonexperts, or core versus developing memes.

**Dedrick** nicely summarizes how and why the approach to cultural evolution outlined in the target article should matter to cognitive science and to anthropology. He suggests that exploring the ways in which cultures emerge to exploit stable cognitive structures may allow psychology and anthropology to join forces to understand what cultures are and how cultures affect their members.

*Response:* Cognitive science has by and large ignored anthropology, except for the use of a few scattered ethnographic anecdotes to bolster this or that argument marginally when the experimental data is not decisive. Anthropology's holistic image of cultures as a "world-view" is predicated on the assumption that differences in life experience imprint themselves on people's innately undifferentiated capacity for "higher-order cognition," thus turning cognition into a black box inscrutable to science. But at least cognitive science (in particular, cognitive psychology and related parts of developmental and social psychology) is increasingly coming to recognize that there are a variety of cognitive systems in any one mind, and that systems of mental repre-

sentations are not distributed equally among human populations. Psychology is now looking to anthropology for help, but is finding that it may just have to deal with culture alone.

Although many of the specific points made in the target article will ultimately be revised or rejected, the article itself is in a sense a plea for a naturalistic approach to anthropology that would harness for science the insights gained from studying and living with other peoples. Many anthropologists would reject the call to science as encouraging a reductive form of power and control over other people's lives. This is a concern we should be alert to, but it is not a necessary or inevitable outcome of having strict and common standards for evaluating what causally unites and divides our species. One can also imagine such knowledge for the good.

### ACKNOWLEDGMENTS

I thank Doug Medin for commenting on this response, and Peter Stevens, Dan Sperber, Adam Morton, Remo Job, and Luca Surian for clarifying their commentaries for me.

### References

**Letters *a* and *r* appearing before authors' initials refer to target article and response respectively.**

- Adanson, M. (1763) *Familles des plantes*, 2 vols. Vincent. [aSA]
- Alexander, R. (1989) Evolution and the human psyche. In: *The human revolution*, ed. C. Stringer. The University of Edinburgh Press. [rSA]
- Anderson, J. (1990) *The adaptive character of thought*. Erlbaum. [aSA]
- Astington, P., Harris, L. & Olson, D., eds. (1988) *Developing theories of mind*. Cambridge University Press. [rSA]
- Atran, S. (1983) Covert fragmenta and the origins of the botanical family. *Man* 18:51–71. [aSA]
- (1985a) The nature of folk-botanical life forms. *American Anthropologist* 87:298–315. [arSA]
- (1985b) Pretheoretical aspects of Aristotelian definition and classification of animals. *Studies in History and Philosophy of Science* 16:113–63. [arSA]
- (1985c) The early history of the species concept. In: *Histoire du concept d'espèce dans les sciences de la vie*, ed. J. Roger & J.-L. Fischer. Editions de la Fondation Singer-Polignac. [rSA]
- (1987a) Origins of the species and genus concepts. *Journal of the History of Biology* 20:195–279. [arSA]
- (1987b) Constraints on the ordinary semantics of living kinds. *Mind and Language* 2:27–63. [arSA]
- (1990) *Cognitive foundations of natural history: Towards an anthropology of science*. Cambridge University Press. [arSA, ESH, MT]
- (1992) The commonsense basis of Buffon's "méthode naturelle." In: *Buffon 88*, ed. J. Gayon. Vrin. [rSA]
- (1993) Itzaj Maya tropical agro-forestry. *Current Anthropology* 34:633–700. [aSA]
- (1994) Core domains versus scientific theories. In: *Mapping the mind: Domain-specificity in cognition and culture*, ed. L. Hirschfeld & S. Gelman. Cambridge University Press. [arSA]
- (1995a) Classifying nature across cultures. In: *Invitation to cognitive science, vol. 3: Thinking*, ed. D. Osherson & E. Smith. MIT Press. [aSA]
- (1995b) Causal constraints on categories and categorical constraints on biological reasoning across culture. In: *Causal cognition*, ed. D. Sperber, D. Premack & A. Premack. Oxford University Press. [rSA]
- (1996) Modes of thinking about living kinds: Science, symbolism and common sense. In: *Modes of thought: Explorations in culture and cognition*, ed. D. R. Olson & N. Torrance. Cambridge University Press. [rSA]
- (in press) Itzaj Maya folk-biological taxonomy. In: *Folk biology*, ed. D. Medin & S. Atran. MIT Press. [arSA]
- Atran, S., Estin, P., Coley, J. & Medin, D. (1979) Generic species and basic levels: Essence and appearance in folk biology. *Journal of Ethnobiology* 17:22–45. [arSA]
- Atran, S. & Medin, D. (1997) Knowledge and action: Cultural models of nature and resource management in Mesoamerica. In: *Environment, ethics, and behavior*, ed. M. Bazerman, D. Messick, A. Tinbrunsel & K. Wayne-Benzoni. Jossey-Bass. [aSA]

- Atran, S., Medin, D., Ross, N., Lynch, B., Coley, J., Ucan Ek', E., Lois, K. & Vapnarsky, V. (under review) Folk ecology and commons management in the Maya Lowlands. [aSA]
- Atran, S. & Sperber, D. (1991) Learning without teaching: Its place in culture. In: *Culture, schooling and psychological development*, ed. L. Tolchinsky-Landsmann. Ablex. [arSA]
- Atran, S. & Ucan Ek', E. (in press) Classification of useful plants among the Northern Peten Maya (Itzaj). In: *Ancient Maya diet*, ed. C. White. The University of Utah Press. [arSA]
- Au, T. & Romo, L. (1996) Building a coherent conception of HIV transmission. In: *The psychology of learning and motivation*, vol. 35, ed. D. Medin. Academic Press. [aSA]
- (in press) Mechanical causality in children's "folk biology." In: *Folk biology*, ed. D. Medin & S. Atran. MIT Press. [rSA]
- Aunger, R. (in preparation) *The epidemiology of belief: Coevolution between memes and their human hosts*. Book MS. [RA]
- Axelrod, R. (1995) The convergence and stability of cultures: Local convergence and global polarization. *Institute of Public Policy Studies Discussion Paper*, No. 375. The University of Michigan, Ann Arbor, February, 1995. [rSA]
- Axelrod, R. & Hamilton, W. (1981) The evolution of cooperation. *Science* 211:1390–96. [rSA]
- Backsieder, A. G., Shatz, M. & Gelman, S. (1993) Preschoolers' ability to distinguish living things as a function of regrowth. *Child Development* 64:1242–57. [AM]
- Baldwin, D. A. & Moses, L. J. (1994) The mindreading engine: Evaluating the evidence for modularity. *Current Psychology of Cognition* 13:553–60. [AL]
- Barkow, J. H., Cosmides, L. & Tooby, J. (1992) *The adapted mind*. Oxford University Press. [WPR]
- Baron-Cohen, S. (1995) *Mindblindness: An essay on autism and theory of mind*. MIT Press. [R], [JL], [AL]
- Barrett, J. L. & Keil, F. C. (1996) Conceptualizing a non-natural entity: Anthropomorphism in God concepts. *Cognitive Psychology* 31:219–47. [PB]
- Bartlett, H. (1936) A method of procedure for field work in tropical American phytogeography based on a botanical reconnaissance in parts of British Honduras and the Peten forest of Guatemala. *Botany of the Maya Area, Miscellaneous Papers I*. Carnegie Institution of Washington Publication 461. [aSA]
- (1940) History of the generic concept in botany. *Bulletin of the Torrey Botanical Club* 47:319–62. [aSA]
- Basso, A., Capitani, E. & Laiacona, M. (1988) Progressive language impairment without dementia: A case study with isolated category-specific semantic defect. *Journal of Neurology, Neurosurgery and Psychiatry* 51:1201–1207. [R]
- Batchelder, W. H. & Romney, A. K. (1988) Test theory without an answer key. *Psychometrika* 53:71–92. [AKR]
- Bellugi, U., Bihle, A., Neville, H., Jernigen, T. & Doherty, S. (1993) Language, cognition, and brain organization in a neurodevelopmental disorder. In: *Developmental behavioral neuroscience*, Minnesota Symposium, ed. M. Gunnar & C. Nelson. Erlbaum. [SCJ]
- Berlin, B. (1972) Speculations on the growth of ethnobotanical nomenclature. *Language and Society* 1:63–98. [aSA, RE]
- (1992) *Ethnobiological classification: Principles of categorization of plants and animals in traditional societies*. Princeton University Press. [aSA, RE, TEH, ESH, REM]
- (in press) One Maya Indian's view of the plant world. In: *Folk biology*, ed. D. Medin & S. Atran. MIT Press. [aSA]
- Berlin, B., Boster, J. S. & O'Neill, J. P. (1981) The perceptual basis of ethnobiological classifications: Evidence from Aguaruna folk ornithology. *Journal of Ethnobotany* 1:95–108. [REM]
- Berlin, B., Breedlove, D. & Raven, P. (1973) General principles of classification and nomenclature in folk biology. *American Anthropologist* 74:214–42. [aSA, ESH]
- (1974) *Principles of Tzeltal plant classification*. Academic Press. [arSA, RE]
- Berlin, B. & Kay, P. (1969) *Basic color terms: Their universality and evolution*. University of California Press. (Updated edition, 1991.) [rSA, DD, AKR, BS, DS]
- Berlin, E. & Berlin, B. (1996) *Medical ethnobiology of the Highland Maya of Chiapas, Mexico*. Princeton University Press. [aSA]
- Bloom, P. (1996) Intention, history, and artifact concepts. *Cognition* 60:1–29. [SCJ], [AM]
- Blythe, P. W., Miller, G. F. & Todd, P. M. (1996) Human simulation of adaptive behavior: Interactive studies of pursuit, evasion, courtship, fighting, and play. In: *From animals to animals 4: Proceedings of the Fourth International Conference on Simulation of Adaptive Behavior*, ed. P. Maes, M. J. Mataric, J.-A. Meyer, J. Pollack & S. W. Wilson. MIT Press/Bradford Books. [PMT]
- Bock, W. (1973) Philosophical foundations of classical evolutionary taxonomy. *Systematic Zoology* 22:275–392. [aSA]
- Boster, J. (1988) Natural sources of internal category structure. *Memory and Cognition* 16:258–70. [aSA]
- Boster, J. & Johnson, J. (1989) Form or function: A comparison of expert and novice judgments of similarity among fish. *American Anthropologist* 88:429–36. [rSA]
- Boyd, R. & Richerson, P. J. (1985) *Culture and the evolutionary process*. The University of Chicago Press. [DS]
- Boyer, P. (1993) Pseudo-natural kinds. In: *Cognitive aspects of religious symbolism*, ed. P. Boyer. Cambridge University Press. [RA]
- (1994a) *The naturalness of religious ideas*. University of California Press. [arSA, DS]
- (1994b) Cognitive constraints on cultural representations: Natural ontologies and religious ideas. In: *Mapping the mind: Domain-specificity in cognition and culture*, ed. L. A. Hirschfeld & S. A. Gelman. Cambridge University Press. [PB]
- Brown, C. (1984) *Language and living things: Uniformities in folk classification and naming*. Rutgers University Press. [aSA]
- Brown, R. W. (1958) How shall a thing be called? *Psychological Review* 65:14–21. [GEAS]
- Brown, R. W. & Lenneberg, E. H. (1954) A study in language and cognition. *Journal of Abnormal and Social Psychology* 49:454–62. [DD]
- Brunfels, O. (1530–1536) *Hebariumviciae eicones*. Schottu. [aSA]
- Bulmer, R. N. H. (1968) Worms that croak and other mysteries of Karam natural history. *Mankind* 6:621–39. [TEH]
- (1970) Which came first, the chicken or the egg-head? In: *Echanges et communications: Mélanges offerts à Claude Lévi-Strauss*, ed. J. Pouillon & P. Maranda. Mouton. [aSA]
- Bunn, H. (1983) Evidence on the diet and subsistence patterns of Plio-Pleistocene hominids at Koobi Fora, Kenya, and at Olduvai Gorge, Tanzania. In: *Animals and archaeology*, ed. J. Clutton-Brock & C. Grigson. London: British Archaeological Reports. [aSA]
- Cain, A. (1956) The genus in evolutionary taxonomy. *Systematic Zoology* 5:97–109. [aSA]
- Caramazza, A. & Shelton, J. R. (in press) Domain-specific knowledge in the brain: The animate-inanimate distinction. [R]
- Carey, S. (1985) *Conceptual change in childhood*. MIT Press. [arSA, SCJ], [AM]
- (1995) On the origins of causal understanding. In: *Causal cognition: A multidisciplinary debate*, ed. D. Sperber, J. Premack & A. Premack. Clarendon Press. [SCJ]
- (1996) Cognitive domains as modes of thought. In: *Modes of thought*, ed. D. Olson & N. Torrance. Cambridge University Press. [arSA]
- Carlson, G. & Pelletier, F. (1995) *The generic book*. University of Chicago Press. [MT]
- Cavalli-Sforza, L. L. & Feldman, M. W. (1981) *Cultural transmission and evolution: A quantitative approach*. Princeton University Press. [DS]
- Cerella, J. (1979) Visual classes and natural categories in the pigeon. *Journal of Experimental Psychology: Human Perception and Performance* 5:68–77. [WPR]
- Cesalpino, A. (1583) *De plantis libri XVI*. Marescot. [arSA]
- Chomsky, N. (1972) *Language and mind*. Harcourt Brace, Jovanovich. [DD]
- Clark, G. (1992) *Space, time and man: A prehistorian's view*. Cambridge University Press. [REM]
- Clément, D. (1995) Why is taxonomy utilitarian? *Journal of Ethnobiology* 15:1–44. [ESH]
- Coley, J. (1995) Emerging differentiation of folk biology and folk psychology: Attributions of biological and psychological properties to living things. *Child Development* 66:1856–74. [rSA]
- Coley, J., Lynch, E., Proffitt, J., Medin, D. & Atran, S. (in press) Inductive reasoning in folk-biological thought. In: *Folk biology*, ed. D. Medin & S. Atran. MIT Press. [arSA]
- Coley, J., Medin, D. & Atran, S. (1997) Does rank have its privilege? Inductive inferences in folkbiological taxonomies. *Cognition* 63:77–112. [arSA]
- Cosmides, L. (1989) The logic of social exchange: Has natural selection shaped how humans reason? Studies with the Wason selection task. *Cognition* 31:187–276. [KRL]
- Cosmides, L. & Tooby, J. (1989) Evolutionary psychology and the generation of culture, part II. *Ethology and Sociobiology* 10:51–97. [aSA]
- Cuerrier, A., Kiger, R. W. & Stevens, P. F. (1996) Charles Bessey, evolution, classification, and the New Botany. *Huntia* 9:179–213. [PFS]
- Cuvier, G. (1829) *Le règne animal*, vol. 1, 2nd edition. Déterville. [aSA]
- D'Andrade, R. (1995) *The development of cognitive anthropology*. Cambridge University Press. [ESH, DS]
- Darwin, C. (1859) *On the origins of species by means of natural selection*. Murray. [rSA]
- (1883) *On the origins of species by means of natural selection*, 6th edition. Appleton (originally published 1872). [arSA]

- Davidson, D. (1984a) On the very idea of a conceptual scheme. In: *Inquiries into truth and interpretation*. Clarendon Press. [aSA]
- (1984b) *Inquiries into truth and interpretation*. Clarendon Press. [BS]
- Dawkins, R. (1976) *The selfish gene*. Oxford University Press. [aSA, RE, DS]
- (1982) *The extended phenotype*. Oxford University Press. [DS]
- Dellborg, M. et al. (1995) Vectocardiographic monitoring to assess early vessel patency after reperfusion therapy for acute myocardial infarction. *European Heart Journal* 16:21–29. [REM]
- Dennett, D. (1995) *Darwin's dangerous idea*. Simon and Schuster. [aSA]
- De Renzi, E. & Lucchelli, F. (1994) Are semantic systems separately represented in the brain? The case of living category impairment. *Cortex* 30:3–25. [R]]
- Diamond, J. (1966) Zoological classification of a primitive people. *Science* 151:1102–04. [aSA]
- diSessa, A. (1988) Knowledge in pieces. In: *Constructivism in the computer age*, ed. G. Forman & P. Pufall. Erlbaum. [aSA]
- (1996) What do “just plain folks” know about physics? In: *The handbook of education and human development*, ed. D. Olson & N. Torrance. Blackwell. [aSA]
- Diver, C. (1940) The problem of closely related species living in the same area. In: *The new systematics*, ed. J. Huxley. Clarendon Press. [aSA]
- Donnellan, K. (1971) Necessity and criteria. In: *Readings in the philosophy of language*, ed. J. Rosenberg & C. Travis. Prentice-Hall. [aSA]
- Dougherty, J. (1978) Salience and relativity in classification. *American Ethnologist* 5:66–80. [aSA]
- (1979) Learning names for plants and plants for names. *Anthropological Linguistics* 21:298–315. [arSA]
- Dupré, J. (1981) Natural kinds and biological taxa. *The Philosophical Review* 90:66–90. [aSA]
- (1993) *The disorder of things*. Harvard University Press. [aSA]
- Durham, W. (1991) *Coevolution: Genes, culture and human diversity*. Stanford University Press. [aSA, DS]
- Dwyer, P. D. (1976a) An analysis of Rofaifo mammal taxonomy. *American Ethnologist* 3:425–45. [aSA]
- (1976b) Beetles, butterflies and bats: Species transformation in a New Guinea folk classification. *Oceania* 46:188–205. [TEH]
- Edelman, S. & Intrator, N. (1997) Learning as formation of low-dimensional representation spaces. In: *Proceedings of the 19th Annual Conference of the Cognitive Science Society*. Erlbaum. [KRL]
- Ekman, P. (1992) Facial expressions of emotion: New findings, new questions. *Psychological Science* 3:34–38. [AKR]
- Ekman, P. & Friesen, W. V. (1975) *Unmasking the face: A guide to recognizing emotions from facial clues*. Prentice-Hall. [AKR]
- Eldredge, N. (1986) Information, economics, and evolution. *Annual Review of Ecology and Systematics* 17:351–69. [PMT]
- Ellen, R. (1993) *The cultural relations of classification: An analysis of Nuaulu animal categories from central Seram*. Cambridge University Press. [aSA, RE]
- (1996) The cognitive geometry of nature: A contextual approach. In: *Nature and society: Anthropological perspectives*, ed. G. Palsson & P. Descola. Routledge. [RE]
- (in press) Palms and the prototypicality of trees: Some questions concerning assumptions in the comparative study of categories and labels. In: *The social life of trees*, ed. L. M. Rival. Berg. [RE]
- Farah, M. J., McMullen, P. A. & Meyer, M. M. (1991) Can recognition of living things be selectively impaired? *Neuropsychologia* 29:185–93. [R]]
- Farah, M. J., Hammond, K. M., Mehta, Z. & Ratcliff, G. (1989) Category-specificity and modality-specificity in semantic memory. *Neuropsychologia* 27:193–200. [R]]
- Feyerabend, P. (1975) *Against method*. New Left Review. [aSA]
- Fodor, J. (1983) *Modularity of mind*. MIT Press. [aSA, JL, KRL, BS]
- (1992) A theory of the child's theory of mind. *Cognition* 44:283–96. [AL]
- Fodor, J. A. (1994) Concepts - a pot boiler. *Cognition* 50:95–113. [rSA, JAH]
- Frangiskakis, J. M., Ewart, A. K., Morris, C. A., Mervis, C. B., Bertrand, J., Robinson, B. F., Klein, B. P., Ensing, G. J., Everett, L. A., Green, E. D., Proschel, C., Gutowski, N. J., Noble, M., Atkinson, D. L., Odelberg, S. J. & Keating, M. T. (1996) LIM-kinase hemizyosity implicated in impaired visuospatial constructive cognition. *Cell* 86:59–69. [SC]]
- Gelman, R. (1990) First principles organize attention to and learning about relevant data: Number and the animate-inanimate distinction. *Cognitive Science* 14:79–106. [aSA]
- Gelman, S. (1988) The development of induction within natural kind and artifact categories. *Cognitive Psychology* 20:65–95. [aSA]
- Gelman, S. & Coley, J. (1990) The importance of knowing a dodo is a bird: Categories and inferences in 2-year-old children. *Developmental Psychology* 26:796–804. [rSA]
- Gelman, S., Coley, J. & Gottfried, G. (1994) Essentialist beliefs in children. In: *Mapping the mind*, ed. L. Hirschfeld & S. Gelman. Cambridge University Press. [aSA]
- Gelman, S. & Hirschfeld, L. (in press) How biological is essentialism? In: *Folk biology*, ed. D. Medin & S. Atran. MIT Press. [rSA, GEAS]
- Gelman, S. A. & Markman, E. (1986) Categories and induction in young children. *Cognition* 23:183–208. [SC]]
- Gelman, S. & Wellman, H. (1991) Insides and essences. *Cognition* 38:214–44. [arSA]
- Gentile, D. A. (1993) Just what are sex and gender, anyway? A call for a new terminological standard. *Psychological Science* 4:120–22. [REM]
- Ghiselin, M. T. (1981) Categories, life, and thinking. *Behavioral and Brain Sciences* 4:269–313. [aSA]
- (1997) *Metaphysics and the origin of species*. State University of New York Press. [MTG]
- Gigerenzer, G. (in press) The modularity of social intelligence. In: *Machiavellian intelligence II*, ed. A. Whiten & R. Byrne. Cambridge University Press. [aSA]
- Gigerenzer, G., Todd, P. M. & The ABC Research Group, eds. (in press) *Simple heuristics that make us smart*. Oxford University Press. [PMT]
- Gilmour, J. & Walters, S. (1964) Philosophy and classification. In: *Vistas in botany*, vol. 4: *Recent researches in plant taxonomy*, ed. W. Turrill. Pergamon Press. [aSA]
- Goldstone, R. (1994) Influences of categorization on perceptual discrimination. *Journal of Experimental Psychology: General* 123:178–200. [KRL]
- Goodman, N. (1965) *Fact, fiction and forecast*. Bobbs-Merrill. [rSA]
- Corbet, L. (1995) *Structuralism meets prototype theory and finds reciprocal affection*. Presentation at the 4th International Cognitive Linguistics Conference, Albuquerque, New Mexico. [REM]
- Grandin, T. (1995) *Thinking in pictures*. Doubleday. [JL]
- Greene, E. (1983) *Landmarks in botany*. 2 volumes. Stanford University Press. [aSA]
- Hacking, I. (1995) The lopping effects of human kinds. In: *Causal cognition*, ed. D. Sperber, D. Premack & A. Premack. [rSA]
- Hall, D. G. (1996) Artifacts and origins. Unpublished manuscript. University of British Columbia. [AM]
- Hall, D. G. & Waxman, S. (1993) Assumptions about word meaning: Individuation and basic-level kinds. *Child Development* 64:1550–70. [aSA]
- Hamilton, W. (1964) The genetical revolution of social behavior. *Journal of Theoretical Biology* 7:1–52. [rSA]
- Hampton, J. A. (1995) Testing prototype theory of concepts. *Journal of Memory and Language* 34:686–708. [JAH]
- (1998) Similarity-based categorization and fuzziness of natural categories. *Cognition* 65:137–65. [JAH]
- Harris, P. L. (1995) Developmental constraints on emotion categories. In: *Everyday conceptions of emotions*, ed. J. Russell, J.-M. Fernandez Dols, A. S. R. Manstead & J. Wellenkamp. Kluwer. [AL]
- Hart, J. & Gordon, B. (1992) Neural subsystems for object knowledge. *Nature* 359:60–64. [R]]
- Hart, J., Berndt, R. S. & Caramazza, A. (1985) Category-specific naming deficit following cerebral infarction. *Nature* 316:439–40. [R]]
- Hatano, G. & Inagaki, K. (1994) Young children's naive theory of biology. *Cognition* 50:171–88. [arSA, SCJ, GEAS]
- (1996) Cognitive and cultural factors in the acquisition of intuitive biology. In: *The handbook of education and human development*, ed. D. R. Olson & N. Torrance. Blackwell. [aSA, GH]
- (in press) A developmental perspective on informal biology. In: *Folk biology*, ed. D. Metrin & S. Atran. MIT Press. [rSA]
- Hays, T. E. (1976) An empirical method for the identification of covert categories in ethnobiology. *American Ethnologist* 3:489–507. [REM]
- (1983) Ndumba folk biology and general principles of ethnobotanical classification and nomenclature. *American Anthropologist* 85:592–611. [rSA]
- Healey, C. J. (1978/1979) Taxonomic rigidity in biological folk classification: Some examples from the Maring of New Guinea. *Ethnomedicine* 5:361–84. [TEH]
- Henley, N. (1969) A psychological study of the semantics of animal terms. *Journal of Verbal Learning and Verbal Behavior* 8:176–84. [aSA]
- Herrmann, D. J. & Raybeck, D. (1981) Similarities and differences in meaning in six cultures. *Journal of Cross-Cultural Psychology* 12:194–206. [AKR]
- Herrnstein, R. J. & deVilliers, P. A. (1980) Fish as a natural category for people and pigeons. *The Psychology of Learning and Motivation* 14:59–95. [WPR]
- Hickling, A. & Gelman, S. (1995) How does your garden grow? Evidence of an early conception of plants as biological kinds. *Child Development* 66:856–76. [arSA]
- Hillis, A. E. & Caramazza, A. (1991) Category-specific naming and comprehension impairment: A double dissociation. *Brain* 114:2081–94. [R]]
- Hirschfeld, L. A. (1996) *Race in the making: Cognition, culture and the child's construction of human kinds*. MIT Press. [rSA, PB, ESH, DS]
- Hirschfeld, L. A. & Gelman, S. A., eds. (1994) *Mapping the mind: Domain-specificity in cognition and culture*. Cambridge University Press. [rSA, DS]

- Holman, E. W. (1992) Statistical properties of large published classifications. *Journal of Classification* 9:187–210. [PFS]
- Hull, D. (1988) *Science as a process*. University of Chicago Press. [aSA]
- (1991) Common sense and science. *Biology and Philosophy* 6:467–79. [rSA]
- Hunn, E. (1976) Toward a perceptual model of folk biological classification. *American Ethnologist* 3:508–24. [arSA]
- (1977) *Tzeltal folk zoology*. Academic Press. [rSA]
- (1982) The utilitarian factor in folk biological classification. *American Anthropologist* 84:830–47. [aSA, ESH]
- (1994) Place-names, population density, and the magic number 500. *Current Anthropology* 35:81–85. [ESH]
- Inagaki, K. & Hatano, G. (1991) Constrained person analogy in young children's biological inference. *Cognitive Development* 6:219–31. [rSA]
- Ingold, T. (1996) Hunting and gathering as ways of perceiving the environment. In: *Redefining nature: Ecology, culture and domestication*, ed. R. F. Ellen & K. Fukui. Berg. [RE]
- Isaac, G. (1983) Aspects of human evolution. In: *Evolution from molecules to men*, ed. D. Bendall. Cambridge University Press. [aSA]
- Jacobs, M. (1980) Revolutions in plant descriptions. In: *Liber gratulatorius in honorem H. C. D. De Wit*, ed. J. Arends, G. Boelema, C. de Groot & A. Leeuwenberg. H. Veenman & Zonen. [aSA]
- Johnson, S. C. & Carey, S. (under review) Knowledge enrichment and conceptual change in folk biology: Evidence from people with Williams syndrome. [SCJ]
- Jusseau, A.-L. (1789) *Genera plantarum*. Herissant. [rSA]
- Kalish, C. W. (1995) Essentialism and graded membership in animal and artifact categories. *Memory and Cognition* 23:335–53. [JAH]
- Kay, P. & Berlin, B. (1997) Science ≠ imperialism: There are nontrivial constraints on color naming. *Behavioral and Brain Sciences* 20(2):196–201. [AKR, BS]
- Keil, F. (1979) *Semantic and conceptual development: An ontological perspective*. Harvard University Press. [arSA]
- (1989) *Concepts, kinds, and cognitive development*. MIT Press. [rSA]
- (1992) The origins of an autonomous biology. In: *Minnesota Symposia on Child Psychology*, vol. 25: *Modularity and constraints in language and cognition*, ed. M. Gunnar & M. Maratsos. Erlbaum. [rSA]
- (1994) The birth and nurturance of concepts by domains: The origins of concepts of living things. In: *Mapping the mind: Domain specificity in cognition and culture*, ed. L. Hirschfeld & S. Gelman. Cambridge University Press. [aSA]
- (1995) The growth of understandings of natural kinds. In: *Causal cognition*, ed. S. Sperber, D. Premack & A. Premack. Clarendon Press. [arSA]
- Keil, F. & Silberstein, C. (1996) Schooling and the acquisition of theoretical knowledge. In: *The handbook of education and human development*, ed. D. Olson & N. Torrance. Blackwell. [aSA]
- Kelly, M. & Keil, F. (1985) The more things change . . . : Metamorphoses and conceptual structure. *Cognitive Science* 9:403–16. [rSA]
- Kempton, W. (1978) Category grading and taxonomic relations: A mug is sort of a cup. *American Ethnologist* 5:44–65. [REM]
- Kesby, J. (1979) The Rangi classification of animals and plants. In: *Classifications in their social contexts*, ed. R. Reason & D. Ellen. Academic Press. [aSA]
- Krause, M. A. & Fouts, R. S. (1997) Chimpanzee (*Pan troglodytes*) pointing: Hand shapes, accuracy and the role of eye gaze. *Journal of Comparative Psychology* 111:330–36. [WPR]
- Kripke, S. (1972) Naming and necessity. In: *Semantics of natural language*, ed. D. Davidson & G. Harman. Reidel. [arSA]
- Kuhn, T. (1962) *The structure of scientific revolutions*. University of Chicago Press. [aSA]
- Kummer, H. (1995) Causal knowledge in animals. In: *Causal cognition*, ed. S. Sperber, D. Premack & A. Premack. Clarendon Press. [aSA]
- Kummer, H., Daston, L., Gigerenzer, G. & Silk, J. (in press) The social intelligence hypothesis. In: *Human by nature*, ed. P. Weingart, P. Richerson, S. Mitchell & S. Maasen. Erlbaum. [aSA]
- Labandeira, C. & Sepkoski, J. (1993) Insect diversity in the fossil record. *Science* 261:310–15. [aSA]
- Laiacona, M., Barbarotto, R. & Capitani, E. (1993) Perceptual and associative knowledge in category-specific impairment of semantic memory: A study of two cases. *Cortex* 29:727–40. [RJ]
- Lakatos, I. (1978) *The methodology of scientific research programs*. Cambridge University Press. [aSA]
- Lamarck, J. (1809) *Philosophie zoologique*. Dentu. [aSA]
- Lancy, D. F. & Strathern, A. J. (1981) Making twos: Pairing as an alternative to the taxonomic mode of representation. *American Anthropologist* 83:773–95. [RE]
- Langer, J. (1996) Heterochrony and the evolution of primate cognitive development. In: *Reaching into thought*, ed. A. E. Russon, K. A. Bard & S. T. Parker. Cambridge University Press. [WPR]
- Latour, B. (1987) *Science in action*. Harvard University Press. [aSA]
- Leavens, D. A. & Hopkins, W. D. (in press) Intentional communication by chimpanzees: A cross-sectional study of the use of referential gestures. *Developmental Psychology*. [WPR]
- Leslie, A. M. (1994) ToMM, ToBy, and Agency. Core architecture and domain specificity. In: *Mapping the mind: Domain specificity in cognition and culture*, ed. L. A. Hirschfeld & S. A. Gelman. Cambridge University Press. [AL]
- Lévi-Strauss, C. (1963) The bear and the barber. *The Journal of the Royal Anthropological Institute* 93:1–11. [aSA]
- (1966) *The savage mind*. The University of Chicago Press. [rSA]
- (1969) *The elementary structures of kinship*. Beacon Press. [arSA]
- Lewontin, R. C. (1990) The evolution of cognition. In: *An invitation to cognitive science: Thinking, 1st edition*, ed. D. N. Osherson & E. E. Smith. MIT Press. [JM]
- Lillard, A. S. (1997) Other folks' theories of mind and behavior. *Psychological Science* 8:268–74. [AL]
- (1998) Ethnopsychologies: Cultural variations in theory of mind. *Psychological Bulletin* 123:3–32. [AL]
- Linnaeus, C. (1738) *Classes plantarum*. Wishoff. [rSA]
- (1751) *Philosophia botanica*. G. Kiesewetter. [aSA]
- Livingston, K., Andrews, J. & Harnad, S. (1998) Categorical perception effects induced by category learning. *Journal of Experimental Psychology: Learning, Memory, and Cognition* 24:1–22. [KRL]
- Locke, J. (1848/1689) *An essay concerning human understanding*. Tegg. [aSA]
- López, A., Atran, S., Coley, J., Medin, D. & Smith, E. (1997) The tree of life: Universals of folk-biological taxonomies and inductions. *Cognitive Psychology* 32:251–95. [arSA]
- López, A., Gelman, S., Gutheil, G. & Smith, E. (1992) The development of category-based induction. *Child Development* 63:1070–90. [aSA]
- López, A., Werner, G. M. & Davis, J. N. (in press) "If . . .": Satisficing algorithms for mapping conditional statements onto social domains. In: *Simple heuristics that make us smart*, ed. G. Gigerenzer, P. M. Todd & The ABC Research Group. Oxford University Press. [PMT]
- Lumsden, C. & Wilson, E. O. (1981) *Genes, mind and culture*. Harvard University Press. [aSA, KRL, DS]
- MacLaury, R. E. (1991) Social and cognitive motivations of change: Measuring variability in color semantics. *Language* 67:34–62. [REM]
- (1992) From brightness to hue: An explanatory model of color-category evolution. *Current Anthropology* 33:137–86. [REM]
- (1997) *Color and cognition in Mesoamerica: Constructing categories as advantages*. University of Texas Press. [REM]
- MacLaury, R. E., Almási, J. & Kövecses, Z. (1997) Hungarian *piros* and *vörös*: Color from points of view. *Semiotica* 114-1/2:67–81. [REM]
- Maffie, J. (1997) "Just-so" stories about "Inner cognitive Africa": Some doubts about Sorensen's evolutionary epistemology of thought experiments. *Biology and Philosophy* 12:207–24. [JM]
- Malkiel, Y. (1941) The "amulatado" type in Spanish. *Romance Review* 32:278–95. [REM]
- Malle, B. (1996) Intentionality in attributions: A theory of peoples' behavior. Unpublished manuscript, University of Oregon. [AL]
- Malt, B. (1995) Category coherence in cross-cultural perspective. *Cognitive Psychology* 29:85–148. [KRL]
- Mandler, J., Bauer, P. & McDonough, L. (1991) Separating the sheep from the goats: Differentiating global categories. *Cognitive Psychology* 23:263–98. [arSA]
- Matan, A. (1996) The emergence of the Design Stance in early childhood. Unpublished Ph. D. dissertation. MIT. [AM]
- Mayr, E. (1969) *Principles of systematic zoology*. McGraw-Hill. [aSA]
- (1982) *The growth of biological thought*. Harvard University Press. [rSA]
- McCarthy, R. A. & Warrington, E. K. (1988) Evidence for modality-specific meaning systems in the brain. *Nature* 334:428–30. [RJ]
- Mead, M. (1932) An investigation of the thought of primitive children with special reference to animism. *Journal of the Royal Anthropological Institute* 62:173–90. [rSA]
- Medin, D., Lynch, E., Coley, J. & Atran, S. (1996) The basic level and privilege in relation to goals, theories and similarity. In: *Proceedings of the Third International Workshop on Multistrategy Learning*, ed. R. Michalski & J. Wnek. American Association for Artificial Intelligence. [aSA]
- (1997) Categorization and reasoning among tree experts: Do all roads lead to Rome? *Cognitive Psychology* 32:49–96. [arSA, KRL]
- Medin, M. & Ortony, A. (1989) Psychological essentialism. In: *Similarity and analogical reasoning*, ed. S. Vosniadou & A. Ortony. Cambridge University Press. [rSA]
- Miles, H. L. (1990) The cognitive foundations for reference in a signing orangutan. In: *"Language" and intelligence in monkeys and apes: Comparative developmental perspectives*, ed. S. T. Parker & K. R. Gibson. Cambridge University Press. [WPR]
- Mill, J. (1843) *A system of logic*. Green. [aSA]
- Miller, G. (1978) Practical and lexical knowledge. In: *Cognition and categorization*, ed. E. Rosch & B. Lloyd. Erlbaum. [rSA]

- Millikan, R. (1998) A common structure for concepts of individuals, stuffs, and real kinds: More mama, more milk, and more mouse. *Behavioral and Brain Sciences* 21(1):55–100. [aSA, KRL]
- Morton, A. (1980) *Frames of mind: Constraints on the common-sense conception of the mental*. Clarendon Press. [rSA, KRL]
- Moss, H. E. & Tyler, L. K. (1997) A category-specific semantic deficit for non-living things in a case of progressive aphasia. *Brain and Language* 60:55–58. [RJ]
- Mumme, D. L., Fernald, A. & Herrera, C. (1996) Infants' responses to facial and vocal emotional signals in a social referencing paradigm. *Child Development* 67:3219–37. [AL]
- Neisser, U. (1993) Without perception, there is no knowledge: Implications for artificial intelligence. In: *Natural and artificial minds*, ed. R. G. Burton. SUNY Press. [WPR]
- Norenzayan, A. (1997) Why we have personality theories: An evolutionary analysis of dispositional inference. Paper presented to the seminar on "Models of Nature and Culture," The University of Michigan, Ann Arbor, December, 1997. [rSA]
- Ochs, E. (1988) *Culture and language development*. Cambridge University Press. [AL]
- O'Hara, R. J. (1996) Mapping the space of time: Temporal representations in the historical sciences. *Memoirs of the California Academy of Science* 20:7–17. [PFS]
- Olson, D. R. (1994) *The world on paper: The conceptual and cognitive implications of writing and reading*. Cambridge University Press. [REM]
- Osherson, D. (1997) The diversity phenomenon. Paper presented to the seminar on "Culture and Cognition," The University of Michigan, Ann Arbor, November, 1997. [rSA]
- Osherson, D., Smith, E., Wilkie, O., López, A. & Shafir, E. (1990) Category-based induction. *Psychological Review* 97:85–200. [arSA, ESH]
- Paul, R. A. (1995) Act and intention in Sherpa culture and society. In: *Other intentions: Cultural contexts and the attribution of inner states*, ed. L. Rosen. School of American Research Press. [AL]
- Pietrini, V., Nertempi, P., Vaglia, A., Revello, M. G., Pinna, V. & Ferro-Milone, F. (1988) Recovery from herpes simplex encephalitis: Selective impairments of specific semantic categories with neuroradiological correlation. *Journal of Neurology, Neurosurgery, and Psychiatry* 51:1284–93. [RJ]
- Pinker, S. (1997) *How the mind works*. W. W. Norton. [KRL]
- Pinker, S. & Bloom, P. (1990) Natural language and natural selection. *Behavioral and Brain Sciences* 13:707–27. [arSA]
- Plotkin, H. (1994) *Darwin machines and the nature of knowledge*. Harvard University Press. [KRL]
- Popper, K. R. (1972) *Objective knowledge*. Clarendon Press. [aSA]
- (1984) Critical remarks on the knowledge of lower and higher organisms, the so-called sensory motor systems. In: *Sensory-motor integration in the nervous system*, ed. O. Creutzfeldt, R. F. Schmidt & W. D. Wallis. Springer-Verlag. [WPR]
- Premack, D. (1995) Foreword to Part IV: Causal understanding in naïve biology. In: *Causal cognition: A multidisciplinary debate*, ed. D. Sperber, D. Premack & A. Premack. Clarendon Press. [aSA]
- Premack, D. & Premack, A. (1994) Moral belief: Form versus content. In: *Mapping the mind*, ed. L. Hirschfeld & S. Gelman. Cambridge University Press. [aSA]
- Putnam, H. (1975) The meaning of "meaning." In: *Mind, language and reality, vol. 2: Philosophical papers*. Cambridge University Press. [rSA]
- (1986) Meaning holism. In: *The philosophy of W.V. Quine*, ed. L. Hahn & P. Schlipp. Open Court. [aSA]
- Quine, W. (1960) *Word and object*. Harvard University Press. [rSA, JL]
- (1969) Natural kinds. In: *Ontological relativity and other essays*. Columbia University Press. [aSA]
- Randall, B. (1991) *When is a pig a hog? A guide to confoundingly related English words*. Prentice Hall. [REM]
- Randall, R. & Hunn, E. (1984) Do life-forms evolve or do uses for life? Some doubts about Brown's universal hypotheses. *American Ethnologist* 11:329–49. [ESH]
- Raven, P., Berlin, B. & Breedlove, D. (1971) The origins of taxonomy. *Science* 174:1210–13. [aSA]
- Ray, V. (1953) Human color perception and behavioral response. *Transactions of the New York Academy of Sciences* 2(16):98–105. [DD]
- Reed, E. S. (1988) The affordances of the animate environment: Social science from the ecological point of view. In: *What is an animal?*, ed. T. Ingold. Unwin Hyman. [RE]
- Rey, G. (1983) Concepts and stereotypes. *Cognition* 15:237–62. [aSA]
- Richardson, R. C. (1996) The prospects for an evolutionary psychology: Human language learning and human reasoning. *Minds and Machines* 6:541–57. [JM]
- Rips, L., Shoben, E. & Smith, E. (1973) Semantic distance and the verification of semantic relations. *Journal of Verbal Learning and Verbal Behavior* 12:1–20. [aSA]
- Romney, A. K., Batchelder, W. H. & Brazill, T. J. (1995) Scaling semantic domains. In: *Geometric representations of perceptual phenomena*, ed. R. D. Luce, M. D'Zmura, D. Hoffman, G. J. Iverson & A. K. Romney. Erlbaum. [AKR]
- Romney, A. K., Boyd, J. P., Moore, C. C., Batchelder, W. H. & Brazill, T. J. (1996) Culture as shared cognitive representations. *Proceedings of the National Academy of Sciences USA* 93:4699–705. [AKR]
- Romney, A. K., Moore, C. C. & Brazill, T. J. (1998) Correspondence analysis as a multidimensional scaling technique for nonfrequency similarity matrices. In: *Visualization of categorical data*, ed. M. Greenacre & J. Blasius. Academic Press. [AKR]
- Romney, A. K., Moore, C. C. & Rusch, C. D. (1997) Cultural universals: Measuring the semantic structure of emotion terms. *Proceedings of the National Academy of Sciences USA* 94:5489–94. [AKR]
- Romney, A. K., Weller, S., & Batchelder, W. (1986) Culture as consensus: A theory of culture and informant accuracy. *American Anthropologist* 88:313–38. [aSA, AKR]
- Rosch, E. (1972) Universals in color naming and memory. *Journal of Experimental Psychology* 93:10–20. [DD]
- (1975) Universals and cultural specifics in categorization. In: *Cross-cultural perspectives on learning*, ed. R. Brislin, S. Bochner & W. Lonner. Halstead. [arSA]
- Rosch, E., Mervis, C., Grey, W., Johnson, D. & Boyes-Braem, P. (1976) Basic objects in natural categories. *Cognitive Psychology* 8:382–439. [aSA, KRL, GEAS]
- Russell, B. (1948) *Human knowledge: Its scope and limits*. Simon & Schuster. [aSA]
- (1957) Mr Strawson on referring. *Mind* 66:385–89. [aSA]
- (1958) *The ABC of relativity*. Allen & Unwin. [aSA]
- Sacchett, C. & Humphreys, G. W. (1992) Calling a squirrel a squirrel but a canoe a wigwam: A category-specific deficit for artifactual objects and body parts. *Cognitive Neuropsychology* 9:73–86. [RJ]
- Sahlins, M. (1976) Colors and cultures. *Semiotica* 16:1–22. [DD]
- Sartori, G. & Job, R. (1988) The oyster with four legs: A neuropsychological study of the interaction of visual and semantic information. *Cognitive Neuropsychology* 5:105–32. [RJ]
- Sartori, G., Job, R., Miozzo, M., Zago, S. & Marchiori, G. (1992) Category-specific form knowledge deficit in a patient with herpes simplex virus encephalitis. *Journal of Clinical and Experimental Neuropsychology* 15:280–99. [RJ]
- Sartori, G., Miozzo, M. & Job, R. (1993) Category-specific naming impairments? Yes. *The Quarterly Journal of Experimental Psychology* 46:489–504. [RJ]
- Saunders, B. (1998) What is colour? Review article of E. Thompson. *Colour vision. A study in cognitive science and the philosophy of perception* (1995). *British Journal of Psychology* (in press). [BS]
- Saunders, B. A. C. & van Brakel, J. (1997) Are there non-trivial constraints on colour categorization. *Behavioral and Brain Sciences* 20(2):167–79. [AKR, BS]
- Schacter, D. (1996) *Searching for memory: The brain, the mind, and the past*. Basic Books. [RA]
- Schwartz, S. (1978) Putnam on artifacts. *Philosophical Review* 87:566–74. (1979) Natural kind terms. *Cognition* 7:301–15. [aSA, AM]
- Schyns, P. G., Goldstone, R. L. & Thibaut, J.-P. (1998) The development of features in object concepts. *Behavioral and Brain Sciences* 21(1):1–54.
- Shepard, R. (1987) Evolution of a mesh between principles of the mind and regularities of the world. In: *The latest on the best: Essays on evolution and optimality*, ed. J. Dupre. MIT Press. [KRL]
- Sheridan, J. & Humphreys, G. W. (1993) A verbal semantic category-specific recognition impairment. *Cognitive Neuropsychology* 10:143–84. [RJ]
- Silveri, M. C. & Gaimotti, G. (1988) Interaction between visions and language in category-specific semantic impairment. *Cognitive Neuropsychology* 5:677–709. [RJ]
- Simpson, G. (1961). *Principles of animal taxonomy*. Columbia University Press. [arSA]
- Slovan, S., Malt, B. & Shi, M. (1997) *The relation of similarity to naming: Chinese versus American conceptions of bottles and jars*. Erlbaum. [KRL]
- Smedslund, J. (1991a) The pseudoempirical in psychology and the case for psychology. *Psychological Inquiry* 2:325–39. [BS]
- (1991b) Psycho-logic: A technical language for psychology. *Psychological Inquiry* 2:376–82. [BS]
- Sober, E. (1993) *Philosophy of biology*. Westview Press. [JM]
- Solomon, G. E. A. & Cassimatis, N. L. (1996) On facts and conceptual systems: Young children's integration of their understandings of germs and contagion (submitted). [GEAS]
- Sommers, F. (1959) The ordinary language tree. *Mind* 68:160–85. [rSA]

- Spelke, E. (1990) Principles of object perception. *Cognitive Science* 14:29–56. [aSA]
- Sperber, D. (1985) Anthropology and psychology: Towards an epidemiology of representations. *Man* 20:73–89. [aSA, PB]
- (1994) The modularity of thought and the epidemiology of representations. In: *Mapping the mind*, ed. L. Hirschfeld & S. Gelman. Cambridge University. [aSA, DD]
- (1996a) *La contagion des idées*. Editions Odile Jacob. [aSA]
- (1996b) *Explaining culture: A naturalistic approach*. Blackwell. [rSA, RA, DS]
- Sperber, D. & Wilson, D. (1986) *Relevance*. Blackwell. [aSA]
- Stevens, P. F. (1994a) Berlin's "Ethnobiological classification." *Systematic Biology* 43:293–95. [aSA]
- (1994b) *The development of biological systematics*. Columbia University Press. [PFS]
- (1998) Mind, memory and history: How classifications are shaped by and through time. *Zoologica Scripta* 27. [PFS]
- Stringer, C. & Gamble, C. (1993) *In search of the Neanderthals*. Thames & Hudson. [WPR]
- Stross, B. (1973) Acquisition of botanical terminology by Tzeltal children. In: *Meaning in Mayan languages*, ed. M. Edmonson. Mouton. [arSA, TEH]
- Surian, L. & Leslie, A. (in press) Competence and performance in false belief understanding: A second look at "look first." *British Journal of Developmental Psychology* [R]
- Tanaka, J. & Taylor, M. (1991) Object categories and expertise: Is the basic level in the eye of the beholder? *Cognitive Psychology* 23:457–82. [aSA]
- Taylor, J. R. (1992) A problem with synonyms (and a way to a solution). *South African Journal of Linguistics* 10:99–104. [REM]
- Taylor, J. R., Mondry, H. & MacLaury, R. E. (1997) A cognitive ceiling of eleven basic color terms. In: *Colored cognition in Mesoamerica: Constructing categories as advantages, appendix IV*, by R. E. MacLaury. University of Texas Press. [REM]
- Thompson, M. (1995) The representation of life. In: *Virtues and reasons*, ed. R. Hursthouse, G. Lawrence & W. Quinn. Oxford University Press. [MT]
- Todd, P. M. & Miller, G. F. (1997) Biodiversity through sexual selection. In: *Artificial life V: Proceedings of the Fifth International Workshop on the Synthesis and Simulation of Living Systems*, ed. C. G. Langton & K. Shimohara. MIT Press/Bradford Books. [PMT]
- Tomasello, M., Kruger, A. C. & Ratner, H. H. (1993) Cultural learning. *Behavioral and Brain Sciences* 16:495–510. [PB]
- Tooby, J. & Cosmides, L. (1992) The psychological foundations of culture. In: *The adapted mind*, ed. J. Barkow, L. Cosmides & J. Tooby. Oxford University Press. [aSA, DS]
- Tournefort, J. (1694) *Éléments de botanique*. Imprimerie Royale. [arSA]
- Trivers, R. (1971) The evolution of reciprocal altruism. *The Quarterly Review of Biology* 46:35–57. [rSA]
- Vauclair, J. (1996) *Animal cognition: An introduction to modern comparative psychology*. Harvard University Press. [WPR]
- Wallace, A. (1901) *Darwinism*, 2nd edition. Macmillan (1st edition 1889). [arSA]
- Warburton, F. (1967) The purposes of classification. *Systematic Zoology* 16:241–45. [aSA]
- Warrington, E. K. & McCarthy, R. A. (1983) Category-specific access dysphasia. *Brain* 106:859–78. [R]
- (1987) Categories of knowledge: Further fractionation and an attempted integration. *Brain* 100:1273–96. [R]
- Warrington, E. K. & Shallice, T. (1984) Category-specific semantic impairments. *Brain* 107:829–54. [R]
- Wellman, H. M. (1995) Young children's conception of mind and emotion. In: *Everyday conceptions of emotions*, ed. J. Russell, J.-M. Fernandez Dols, A. S. R. Manstead & J. Wellenkamp. Kluwer. [AL]
- Wellman, H. M. & Gelman, S. A. (1992) Cognitive development: Foundational theories of core domains. In: *Annual review of psychology, Vol. 43*, ed. M. R. Rosenzweig & L. W. Porter. Annual Reviews. [AL]
- (1998) Knowledge acquisition in foundational domains. In: *Handbook of child psychology: Vol. 2. Cognition, perception, and language development, 5th edition*, ed. D. Kuhn & R. S. Siegler. Wiley. [AL]
- Wellman, H. M. & Inagaki, K., eds. (1997) *New directions for child development, No. 75: The emergence of core domains of thought: Child's reasoning about physical, psychological, and biological phenomena*. Jossey-Bass. [rSA]
- Witkowski, S. R., Brown, C. H. & Chase, P. K. (1981) Where do tree terms come from? *Man (N. S.)* 16:1–14. [RE]
- Wynn, K. (1992) Children's acquisition of the number words and the counting system. *Cognitive Psychology* 24:220–51. [PB]
- Zubin, D. & Köpcke, K.-M. (1986) Gender and folk taxonomy. In: *Noun classes and categorization*, ed. C. Craig. John Benjamins. [aSA]