

A neurobehavioral model of affiliative bonding: Implications for conceptualizing a human trait of affiliation

**Richard A. Depue and
Jeannine V. Morrone-Strupinsky**

Laboratory of Neurobiology of Temperament and Personality, Department of Human Development, Cornell University, Ithaca, NY 14853.

rad5@cornell.edu jvm1@cornell.edu

Abstract: Because little is known about the human trait of *affiliation*, we provide a novel neurobehavioral model of affiliative bonding. Discussion is organized around processes of reward and memory formation that occur during approach and consummatory phases of affiliation. Appetitive and consummatory reward processes are mediated independently by the activity of the ventral tegmental area (VTA) dopamine (DA)–nucleus accumbens shell (NAS) pathway and the central corticolimbic projections of the *u*-opiate system of the medial basal arcuate nucleus, respectively, although these two projection systems functionally interact across time. We next explicate the manner in which DA and glutamate interact in both the VTA and NAS to form incentive-encoded contextual memory ensembles that are predictive of reward derived from affiliative objects. Affiliative stimuli, *in particular*, are incorporated within contextual ensembles predictive of affiliative reward via: (a) the binding of affiliative stimuli in the rostral circuit of the medial extended amygdala and subsequent transmission to the NAS shell; (b) affiliative stimulus-induced opiate potentiation of DA processes in the VTA and NAS; and (c) permissive or facilitatory effects of gonadal steroids, oxytocin (in interaction with DA), and vasopressin on (i) sensory, perceptual, and attentional processing of affiliative stimuli and (ii) formation of social memories. Among these various processes, we propose that the capacity to experience affiliative reward via opiate functioning has a disproportionate weight in determining individual differences in affiliation. We delineate sources of these individual differences, and provide the first human data that support an association between opiate functioning and variation in trait affiliation.

Keywords: affiliation corticolimbic-striatal networks; appetitive and consummatory reward; dopamine; oxytocin; personality; social bonds; social memory; *u*-opiates

1. Overview

Because of the length of this target article, the reader is provided with a brief overview. Moreover, several of the longer sections in the article begin with a brief introduction, which attempts to guide the reader through the major topics covered in those sections.

The goal of this article is to provide a detailed analysis of a human trait of affiliation, a trait that has received relatively little attention in terms of its psychobiological foundation. There are three major components to the article: (i) delineation of the construct of affiliation from the standpoint of its place in the trait structure of personality, its central behavioral and affective features, and the core behavioral-motivational processes underlying the construct (sects. 2–5); (ii) analysis of the neurobehavioral foundation of the core processes defined in component (i) and exploration of the neurodevelopmental sources of individual differences in trait affiliation (sects. 6 and 7); and (iii) modeling the behavioral effects of individual differences in the neurochemistry posited to be critical for the acquisition and maintenance of affiliative bonds (sect. 8).

RICHARD DEPUE is Professor of Neurobiology of Temperament and Personality at Cornell University. His research focuses on the neurobehavioral foundations (interconnected neuroanatomical regions and the neurotransmitters/neuropeptides that modulate these regions) underlying four major traits of temperament and personality, including extraversion, affiliative bonding, constraint, and anxiety. His interest in this area comprises the range of normal behavior, as well as theoretical models of personality disorders that are based on the interaction of all four traits (e.g., Depue & Lenzenweger 2005). He is currently working on a conceptual model concerning the manner in which personality traits are stable within a plastic neural environment.

JEANNINE MORRONE-STRUPINSKY is a clinical psychologist with research interests in the biology of emotion and personality. She is currently a postdoctoral trainee in neuroimaging, where she is studying the variation in neural regions associated with extraversion versus affiliative bonding.

In the first component of the article, affiliation is seen to represent but one domain of interpersonal behavior, and we attempt in Section 2 (“Interpersonal behavior and the structure of personality”) to position the affiliative domain within the structure of personality as defined by psychometric analyses. Because of the variation in the descriptions of the construct of affiliation in psychological and trait literatures, Section 3 (“Trait affiliation”), relying on the content of personality measures of affiliation, delineates which phenotypic features we believe to be central rather than peripheral to the construct. This analysis is critical, because the definition of the construct of affiliation will lead in certain directions in attempting to posit which core behavioral-motivational processes underlie affiliative behavior. As discussed in Section 4 (“Core behavioral-motivational processes underlying affiliation”), we conclude that three core processes underlie affiliation: appetitive and consummatory phases of reward processes, and the formation of affiliative memories, which depends in part on the former reward processes. Section 5 (“Hierarchical structure of an affiliation trait”) integrates the preceding discussion by providing a hierarchical structure of an affiliation trait that delineates the critical eliciting stimuli, the core behavioral and affective processes, and the resulting affiliative behavior and affect.

The second major component of the article provides a neurobehavioral foundation for the core processes defined in the first major component (sect. 6, “Neurobehavioral foundation of the core processes underlying trait affiliation”). First, the neurochemistry associated with the appetitive phase of affiliation is explored, with emphasis on the role of dopamine in incentive-reward motivation. Next, opiates are discussed as being a critical part of the reward processes associated with the consummatory phase of affiliation. Third, a major affective consequence of consummatory processes accompanies the physiological quiescence associated with consummation. We discuss the neurobiology of this quiescence and how opiates may facilitate it. Finally, the basic neurobehavioral foundation of the formation of affiliative memories is presented, with the focus being on the neural integration or binding of all contextual elements accompanying, and hence predicting, affiliative reward. The binding of context into an ensemble that represents the context of reward, and attributing an incentive-reward salience to that ensemble, represents the basis of forming affiliative memories. The interaction of dopamine and glutamate in this process is described. As we are concerned with affiliative behavior, our interest is in how, neurobiologically, affiliative stimuli are enhanced when the contextual ensemble is formed. We discuss three ways in which affiliative stimuli may be enhanced: (1) by being neurally integrated in the medial extended amygdala, (2) by interactions of opiates with glutamate and dopamine in the nucleus accumbens, where the ensemble is compressed and formed, and (3) by the role of gonadal steroids, oxytocin, and vasopressin in enhancing perception and memory of affiliative stimuli and in interacting with opiates and dopamine. Finally, the neurobehavioral treatment of affiliation would be incomplete from a trait perspective unless we specify how individual differences arise within the relevant neurobiological processes. Therefore, Section 7 attempts to define the neurodevelopmental sources of individual differences in trait affiliation. This discussion focuses on genetic influences on opiate and dopamine functioning, but subsequently explores how experiential processes, es-

pecially experience-dependent ones, may influence the neurobehavioral processes described in Section 6.

The third component of the article models the behavioral effects of individual differences in opiate functioning on the acquisition and maintenance of affiliative bonds (sect. 8: “Modeling Behavioral Effects of Individual Differences in *u*-Opiate Functioning on the Acquisition and Maintenance of Affiliative Bonds”). The focus on opiate functioning comes from our proposition that opiates mediate a capacity for affiliative reward, which to us is the *sine qua non* for forming an affiliative bond. The article concludes with the presentation of our initial study of the association of opiate functioning with a human trait of affiliation (sect. 8.3: “Preliminary Support for Opiate Involvement in Trait Affiliation”), followed by concluding remarks (sect. 9).

2. Interpersonal behavior and the structure of personality

The structure of temperament and personality is comprised of a relatively small number (4–5) of higher-order traits. As originally proposed by Gray (1973) and extended by others (Cloninger 1986; Depue & Collins 1999; Netter et al. 1996; White & Depue 1999; Zuckerman 1991), higher-order traits reflect emotional-motivational systems that evolved to increase adaptation to classes of stimuli associated with positive and negative reinforcement. For example, fear evolved to motivate escape behavior in the presence of unconditioned aversive stimuli that threaten survival. Individual differences in personality traits thereby reflect variation in the sensitivity to such stimuli and, overall, personality represents the relative strength of sensitivities to various stimulus classes. Within this framework, sensitivity ultimately means reactivity of neurobiological processes closely associated with a motivational system.

In view of the interdependence of personality traits, reinforcing stimuli, and motivational systems, it is not surprising that the higher-order structure of personality is substantially associated with the domain of interpersonal behavior. Other people are critical to the preservation of our species in mating, caring of offspring, and social cooperation required in tasks critical to survival, such as protection and food procurement. Until relatively recently, the interpersonal domain of personality was embodied largely in one higher-order trait termed *extraversion* which, despite terminological variation, is identified in virtually every taxonomy of personality (Buss & Plomin 1984; Cattell et al. 1980; Cloninger et al. 1993; Comrey 1970; Costa & McCrae 1985; 1992; Digman 1990; Eysenck & Eysenck 1975; 1985; Goldberg 1981; Guilford & Zimmerman 1949; Jackson 1984; Tellegen & Waller, in press; Zuckerman 1994a).

More recent structural work in personality, including a five-factor structure of personality (Digman 1990), has demonstrated that the interpersonal nature of extraversion is not unitary, but rather is composed of two independent higher-order traits (Digman 1990; Tellegen & Waller, in press). One trait has been variably called communion, social closeness, and agreeableness (in the five-factor model), but we prefer the more generic term *affiliation* to maintain a conceptual bridge to animal neurobehavioral work (Carter et al. 1997). Affiliation reflects enjoying and valuing close interpersonal bonds and being warm and affectionate; whereas the other trait associated with extroversion, *agency*,

reflects social dominance and the enjoyment of leadership roles, assertiveness, and a subjective sense of potency in accomplishing goals. Prior to the more recent recognition of their independence, these two traits were represented, respectively, as different aspects of extraversion, such as Warmth-Gregariousness versus Assertiveness (Costa & McCrae 1992), Social Closeness versus Social Potency (Tellegen & Waller, in press), Sociability versus Ascendance-Dominance (in Social Activity; Guilford & Zimmerman 1949), Warmth (in Agreeableness) versus Assertion (in Surgency) (Goldberg & Rosolack 1994), Warmhearted-Socially Enmeshed versus Dominant-Ascendant (Cattell et al. 1980), and Sociability versus Ambition (in Surgency) (Hogan 1983). These two traits are also consistent with the two major independent traits identified in the theory of interpersonal behavior: Warm-Agreeable versus Assured-Dominant (Wiggins 1991; Wiggins et al. 1988). These latter two traits form the two major orthogonal dimensions in Figure 1, and they are accompanied by two additional dimensions identified by Wiggins that further characterize interpersonal behavior (referred to as a circumplex), much of interpersonal behavior can be represented as a combination of the two major traits, affiliation and agency.

Church and Burke (1994) supported a two-trait structure of extraversion by demonstrating that the lower-order traits of extraversion measured by Costa and McCrae's (1992) questionnaire factored into agency (assertiveness, activity) and affiliation (warmth, positive emotions, agreeableness). Furthermore, when general affiliation and agency traits

were derived in joint factor analyses of several multidimensional personality questionnaires (Church 1994; Costa & McCrae 1989; Tellegen & Waller, in press) – two general traits were identified in each case as affiliation and agency. This made it possible to plot the loadings of lower-order traits from several studies in relation to the general affiliation and agency traits (see Appendix A). When trait loadings are plotted from different studies, the interrelations among traits will only be approximations in a quantitative sense, but the pattern with respect to the general affiliation and agency traits is instructive. For purposes of comparison, the lower-order traits are plotted within the interpersonal trait structure of Wiggins in Figure 1. Lower-order traits of achievement, persistence, social dominance, and activity all load much more strongly on agency than on affiliation, whereas traits of sociability and agreeableness show a reverse pattern. Lower-order traits of well-being and positive emotions are associated with both agency and affiliation about equally (see also Helgeson 1994), which is likely why affiliation and agency were combined in extraversion previously. But when positive emotion components are statistically removed, the associations among affiliative and agentic scales approach zero (range = 0.11 to -0.08; Watson & Clark 1997). Similar independence of affiliative and agentic traits have been demonstrated by analysis of peer ratings after extensive social interaction experience (Hurley 1998) and the human psychometric studies are supported by comparative studies in nonhuman personality, including the use of primates, wherein independent affiliative and agentic traits have been demonstrated (Byrne & Suomi 1998; Capitanio 1999; Capitanio et al. 1998; Champoux et al. 1997). Indeed, Gosling (2001) has argued that the dimensions of Sociability (affiliation) and Confidence (agency) are fairly widespread in the animal kingdom.

In a comprehensive analysis, we (Depue & Collins 1999) demonstrated that affiliation and agency represent distinct dispositions. Whereas affiliation is clearly interpersonal in nature, agency represents a more general disposition encompassing dominance, ambition, mastery, and efficacy that is manifest in a range of achievement-related, as well as interpersonal, contexts. The focus of that analysis was on the incentive motivational and neurobiological nature of the agentic form of extraversion (Depue & Collins 1999). In this current analysis, we focus on the psychobiological nature of the affiliative form of extraversion, or simply, on a trait of affiliation.

A comprehensive neurobehavioral model of an affiliation trait must specify at least five points: (1) behavioral and emotional characteristics of the trait, particularly those that are central to its definition, (2) core behavioral-motivational processes inferred to underlie those central characteristics, (3) neuroanatomical brain networks and neuromodulators that integrate those core processes, (4) neurobiological variables that account for individual differences in the functioning of the networks, and (5) sources of those individual differences. This target article specifies all five points. As a guide to defining each of these points, we used the analytic strategy outlined in Figure 2, one that is similar to one used in primate personality research (Itoh 2002). Personality psychology, discussed previously, was used to define the broad nature and independence of trait affiliation within the structure of personality, and is also used in Section 3 to delineate its central behavioral and emotional characteristics. We next identify mammalian behavioral processes

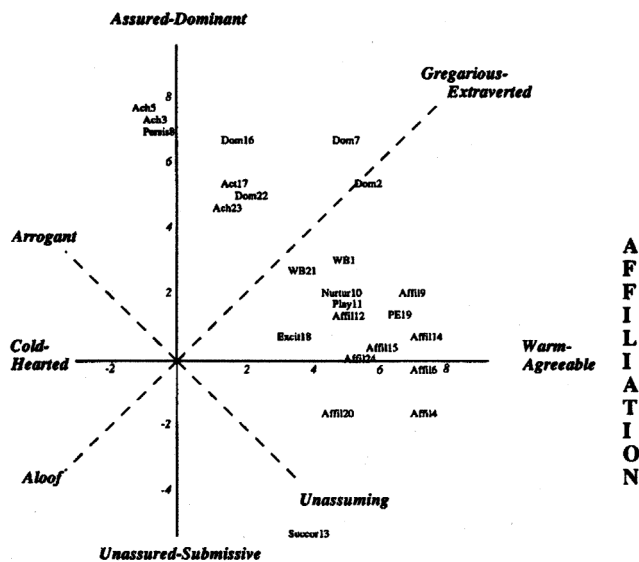

Figure 1. A structure of interpersonal behavior composed of four adjective-labeled dimensions, with the two predominant orthogonal dimensions labeled Agency and Affiliation. The figure illustrates that the interpersonal engagement characteristic of extraversion is composed of two different dispositions: affiliation and agency. Within the structure, lower-order traits representing either agency or affiliation components of extraversion are plotted according to their loadings on general Agency and Affiliation traits derived in several studies. See the Appendix for the identity of the abbreviations of trait measures (shown with numbers), the questionnaires to which the abbreviations correspond, and the studies providing the trait loadings.

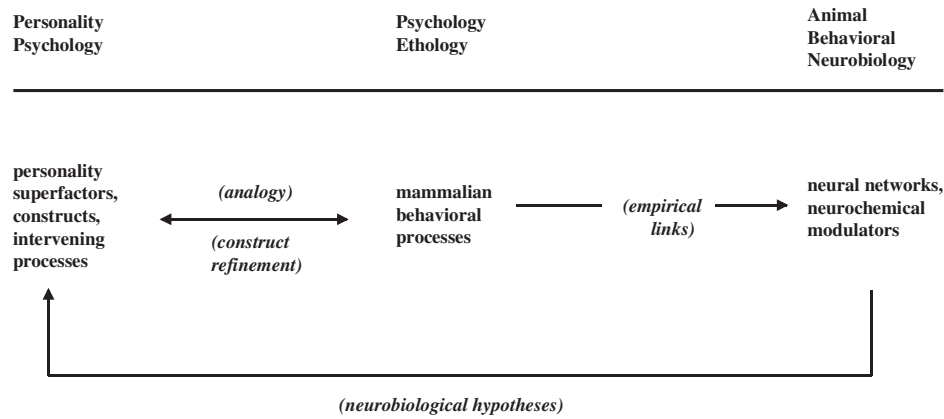

Figure 2. A modeling strategy for deriving neurobiological hypotheses about higher-order traits of personality. See text for details.

(sect. 4) that are believed to underlie those characteristics as described in the psychological and ethological literatures (see Itoh 2002; Timberlake & Silva 1995). Once these processes are identified, animal behavioral neurobiology research provided empirical links to their neural organization and neurochemical modulation, as discussed in Section 6. These behavioral-biology links represent hypotheses concerning the nature of affiliation, which can then be extended to human affiliation and subjected to empirical testing, as described in Section 8.

3. Trait affiliation: Central behavioral-emotional characteristics and differentiation from other constructs of interpersonal behavior

3.1. Central characteristics of trait affiliation

In accord with the strategy outlined in Figure 2, a critical first step is to define the central behavioral-emotional characteristics of trait affiliation, which then may be used to delineate behavioral-motivational processes underlying affiliation. One approach to this problem is to assess the content of items comprising affiliation trait measures. Tellegen's Multidimensional Personality Questionnaire identifies a higher-order affiliation trait termed Social Closeness (Tellegen et al. 1988; Tellegen & Waller, in press), which is independent of the higher-order trait of agentic extraversion. It incorporates two main areas of content. One area, which represents the strongest markers of the trait, assesses subjective feelings and attitudes of affectionateness and warmth versus being cool and distant, and a strong preference for close personal ties, all of which presumably reflect the emotional-cognitive experience that is correlated with neurobiological processes activated by affiliative stimuli. A second area assesses self-reported interpersonal behavior that is sociable, gregarious, and involves turning to others for comfort and support versus being solitary in nature. Together, this content is consistent with the major dimensional trait of Warm-Agreeable versus Cold-Hearted, illustrated in Figure 1 (Wiggins 1991; Wiggins et al. 1988), as well as with the content of other affiliation trait scales of Warmth, Positive Emotions, and Agreeableness (Costa & McCrae 1992), Warm-Hearted, Socially Enmeshed (Cattell et al. 1980), and Sociability (Guilford & Zimmerman 1949; Hogan 1983). Furthermore, in the five-factor model

of the higher-order structure of personality, such interpersonal characteristics are assessed in large part by a trait termed Agreeableness. Agreeableness incorporates at least two components (Costa & McCrae 1992; Digman 1990; Goldberg & Rosolack 1994). The first component is consistent with the content of the affiliation measure of Social Closeness. It includes positive subjective feelings and attitudes toward other individuals, and is characterized most strongly by two groups of adjectives (Goldberg & Rosolack 1994): (a) a *Warmth* group, including warm, affectionate, kind, compassionate, and sympathetic, which is different from the construct of empathy (Preston & de Waal 2001); and (b) an *Amiable* group, including amiable, cordial, and friendly. These groups provide the strongest adjectival markers of the Agreeableness trait (Goldberg & Rosolack 1994). The second component represents social cooperation, which is defined most strongly by adjectives such as helpful, cooperative, accommodating, and agreeable, the latter adjective also being identified in the Warm-Agreeable trait dimension in Figure 1. Perhaps this second component reflects, in part, competitive aggression, which would be important in determining social group formation and cohesion, in that very high levels of competitive aggression (disagreeableness, lack of cooperation) can interfere with the development of social cooperation. Importantly, all of these sets of adjectives correlate near zero with agentic extraversion adjectives such as assertive, bold, excited, strong, peppy, and talkative (Goldberg & Rosolack 1994; Tellegen & Waller, in press), again indicating their independence.

The core content of affiliation scales seems to reflect the operation of neurobehavioral processes that (i) create a warm, affectionate, gratifying subjective emotional state elicited by others, which (ii) motivates close interpersonal behavior. Our hypothesis is that the subjective experience of warmth and affection reflects the *capacity to experience reward that is elicited by a broad array of affiliative stimuli*. This capacity is viewed as providing the key element utilized in additional psychobiological processes that permits the development and maintenance of longer-term affective bonds, defined as long-term selective social attachments observed most intensely between infants and parents and between adult mates, and that are characteristic of social organization in human and other primate societies (Gingrich et al. 2000; Wang et al. 1999). It is important to emphasize that a core capacity for affiliative reward and bonding is not

viewed as a sufficient determinant of close social relationships, only as a necessary one, a *sine qua non*. We discuss other factors in subsequent sections.

3.2. Differentiation from other constructs of interpersonal behavior

Because the broad domain of interpersonal behavior encompasses multiple traits, we differentiate four trait issues relative to the more narrowly defined affiliation trait posited here. First, *sociability* is *quantitative* in nature and refers behaviorally to the frequency of engaging in interpersonal activities with a number of group members. Although most primates are disposed to high sociability, the evolution of sociality reflects a trade-off between costs and benefits of living in close proximity to conspecifics. There are, nevertheless, major benefits that accrue from social integration, because such behavior may increase, to varying degrees, depending on environmental and group circumstances, the ability to gather food, build shelter, obtain coalitionary support in within-group contests, learn about the environment, and gain access to a group of others with whom they may eventually mate (Cassidy 1999; Silk et al. 2003). That social relationships and social integration have adaptive value for baboon primate females was demonstrated recently for the first time in that offspring of the more socially integrated females had higher survival rates, independent of female dominance rank and variation in ecological conditions (Silk et al. 2003). Furthermore, social relationships with adult primate males may be valuable to females because male associates shield females from harassment, support their offspring in agonistic interactions, and can protect the females' infants from predators or infanticidal attacks (Silk et al. 2003). Moreover, in humans, primates, and other species, much literature supports the positive effects of sociality on health and well-being across the life span, including giving birth to heavier infants, delays in reproductive senescence, enhanced longevity, reduced stress responses, and enhanced immune responsiveness (Silk et al. 2003).

These findings suggest that there may be a fundamental behavioral system of sociability based on social cooperation that evolved to promote alliances with others, even in the absence of affective affiliative bonds. Thus, sociability is a broader construct than trait affiliation, which involves *quality* of interactions, based particularly on social reward derived from close interpersonal bonds with specific individuals (Lucas et al. 2000). Indeed, when these two different aspects of interaction (i.e., sociability vs. affiliation) are psychometrically separated, they correlate near zero (Lucas et al. 2000). Sociability can, therefore, be viewed as a higher-order interpersonal trait that may reflect several social motivational processes, including: (a) social approach and social dominance that are part of the incentive motivation underlying agentic extraversion (Depue & Collins 1999); (b) seeking of intimate social contact that is a result of affiliative reward (i.e., trait affiliation); (c) social cooperation (competitive aggression); and (d) avoidance of social isolation, which we posit in more detail below is an unconditionally aversive state because of its evolutionary association with a reduced probability of survival (White & Depue 1999). Thus, it is possible for one to be high on trait affiliation, thereby deriving significant reward from interpersonal contact, but low on a sociability trait (i.e., being engaged in few interpersonal relationships) because, for example, one

shows low levels of social approach associated with agentic extraversion (e.g., see Fig. 1).

3.2.1. Dimensionality of affective bonding. There is disagreement over whether the type of affiliation that occurs in mother–infant pairs and between mates is quantitatively or qualitatively different from that experienced in intimate relationships between close friends. This disagreement may result in part from the fact that this issue involves at least two aspects: (a) whether the basic mechanisms that promote affiliative bonds are the same or different across different types of relationships, and (b) whether all types of affiliative relationships are capable of developing attachment characteristics. In this section, we are specifically referring to aspect (a), whereas attachment is discussed shortly. We, as well as others (Insel 1997; Nelson & Panksepp 1998; Panksepp et al. 1994; 1997; Young et al. 1998), take the position that the basic mechanisms that promote affiliative bonding, particularly a capacity for affiliative reward, provide the foundation for establishing all types of close interpersonal relationships *that have a positive affective component*, and that these mechanisms are elicited by the same modalities of sensory stimuli, even if the social activities that generate the sensory stimulation are different (Crews 1998; Insel 1997; Mason & Mendoza 1998). Certainly, prosocial interactions (e.g., allogrooming, play) and social bonds among nonhuman primates are strengthened by affiliative reward processes, and are necessary for the formation and maintenance of social groups (Silk et al. 2003; Young et al. 1998). Thus, for us, the positive emotional expression of affiliation-induced reward facilitates affiliative tendencies and bonding, and is manifested by nurturance in mother–infant relationships, support in close friendships, and by elements of both, in addition to sexual behavior in mates.

Furthermore, affiliative behavior enables physiological adaptations that facilitate trophotropic processes, such as calmness, relaxation, digestion, metabolism, growth, and healing, and also may foster physiological coregulation of bonding partners (Di Chiara & North 1992; Hofer 1995; Porges 1998; 2001; Uvnas-Moberg 1998). These effects may be experienced in all affectively close affiliative relationships. For example, after a two-month separation period, the mere visual presence (where tactile and auditory cues were isolated) of male mouse *siblings*, but not of unfamiliar mice, decreased tactile pain sensitivity and physiologic arousal to painful stressors, two variables that, similar to affiliative reward, are modulated by opiates (see sects. 6.1.2 and 6.1.3; D'Amato & Provone 1993; 1995). Also, oxytocin, which is released by many sociosexual stimuli (see sect. 6.3.3), is also released during social interaction between conspecifics outside of mate and mother–infant interactions, including interaction between female prairie voles, rats of both sexes, and male squirrel monkeys (Carter et al. 1995). Moreover, non-noxious touch applied by friends, such as gentle stroking, lowers blood pressure and sympathetic activity, and increases pain thresholds and the release of gastrointestinal hormones during delivery of human infants (Knox & Uvnas-Moberg 1998; Uvnas-Moberg 1997). Thus, we believe that the only difference between various affiliative relationships that have a positive affective component is one of degree rather than of kind.

3.2.2. Social attachment. We would argue that trait affiliation as previously defined is a narrower construct than that

of *social attachment*, which is usually applied in a limited manner only to parent–offspring and mate relationships. For us, affiliative reward is one factor that contributes to social attachment and is critical to the development of *secure attachment*. From a neurobehavioral perspective, social attachment appears to be a heterogeneous, higher-order construct, the manifestation of which emerges from the interaction of several neurobehavioral systems (Kraemer 1992) and social experiences (Meaney 2001). For instance, the criteria for attachment in children include proximity-seeking, secure base, and separation distress. *Proximity-seeking*, which means the child seeks to be near the parent, appears to be a complex criterion itself. Proximity can be sought because of a positive desire to be near the source of reward and positive feelings. This is essentially the expression of a preference for a known, rewarding affiliative object, an expression that can be manifested by maintaining a close proximity to the parent or by an incentive-motivated approach to the parent from a distance. Alternatively, seeking proximity can also occur when conditioned cues of punishment arise, where the rewarding affiliative object serves as a safety cue (protection) that elicits incentive-motivated active avoidance and approach to the parent (Depue & Collins 1999). Thus, in this sense, proximity-seeking can reflect the operation of both incentive-motivational and affiliative reward processes. On the other hand, *secure base* can be viewed as a consistency variable, reflecting the consistency with which reward in ratio to nonreward and/or punishment is obtained from the affiliative object. Complexity is increased by the fact that the two criteria of secure base and proximity-seeking are likely to interact at the behavioral level. For example, a child could experience a lack of secure base as a result of inconsistent reward–punishment, while at the same time maintain close proximity based on: (a) an intermittent, variable (unpredictable) schedule of reinforcement, and/or (b) removal or omission of potential aversive circumstances provided by parental protection (passive and active avoidance).

The attachment criterion of *separation anxiety or distress* may be complex, as well, as is the issue of its biological modifiers (see review by Nelson & Panksepp 1998). Although manifestation of separation anxiety or distress is correlated with the existence of an affiliative bond, we take the position, along with others (Insel 1997; Nelson & Panksepp 1998; Panksepp 1998; Panksepp et al. 1994; Young et al. 1998), that processes underlying affiliative bonding are not the same as those involved in social separation distress. Affectively, affiliation and separation are distinctly different and not two sides of a coin. Separation is characterized by the presence of frustration, protest, and anxiety, and not just the absence of warmth and pleasure (and vice versa). In fact, there are data that support a bidimensional organization of affiliation and separation distress, because the neural pathways underlying affiliative engagement (e.g., maternal behavior) may be different from those that allow for inhibition of separation distress (Eisenberger et al. 2003; Insel 1997; Nelson & Panksepp 1998; Winslow & Insel 1991a).

3.2.3. Separation distress. In behavioral terms, separation anxiety or distress may reflect both (a) the anxiety of *uncertainty* generated by removal of protective, supportive, safety cues, and (b) the agitated dysphoria that accompanies loss of a significant source of reward when no chance of reacquiring the rewarding object appears to exist (Gray

1973; 1992). From a broader evolutionary perspective, separation leading to social isolation can be characterized as unconditionally aversive, having *no discrete, explicit stimulus source* – similar to the human experience of being in the dark (or being in bright light in nocturnal mammals) (Davis et al. 1997; Davis & Shi 1999; White & Depue 1999). That this aversiveness is severe is indicated by the fact that socially isolated nonhuman primates do not survive in the wild, dying of exposure, lack of nourishment, or predation within days to weeks (Steklis & Kling 1985). In humans, social isolation, rejection, and/or ostracization generate a sense of anxiety and apprehension. Put differently, separation anxiety or distress may, in part, reflect a very basic neurobehavioral anxiety system that serves to motivate attempts to reverse social isolation via reintegration into a social group (Barlow 2002; White & Depue 1999). It may be that separation anxiety or distress is associated with other related traits such as rejection sensitivity and dependency, both of which reflect anxiety related to social isolation. This system would be associated with neural networks involved in recognition of social uncertainty and rejection, experience of psychic pain (Eisenberger et al. 2003), and expression of anxiety as opposed to affiliative reward per se.

In sum, we view a capacity to experience affiliative reward as the necessary component in acquiring and maintaining affiliative bonds. Affiliative reward is hypothesized to underlie all human social relationships having a positive affective component, whereby such relationships are viewed as qualitatively similar, varying in affiliative strength but not in kind. Other interpersonal constructs of sociability, attachment, and separation anxiety are accordingly viewed as either broader than affiliation as defined here, and/or as based on different neurobehavioral systems.

4. Core behavioral-motivational processes underlying affiliation

The need to preserve the human species through reproduction and group cohesion has given rise to a number of mammalian neurobehavioral processes that support different aspects of sociosexual interaction. These processes may be arbitrarily divided into four components: (a) *preparation or approach*, whereby individuals are brought together for an affiliative exchange; (b) *consummation*, whereby individuals (i) display and engage in specific social, courtship, and mating behaviors, and (ii) experience relaxation and satiety as a result of the sensory exchange during, and reduced physiological arousal following, consummation (Porges 1998; 2001; Uvnas-Moberg 1997); (c) *short-term affective bonding*, involving parturition, lactation, and maternal and paternal parenting behavior as a means of ensuring immediate offspring survival; and (d) *longer-term affective bonding* to maintain bonds (i) between parent–infant and mate pairs during more prolonged offspring developmental periods, and (ii) more generally, between individuals to promote formation of social groups that are necessary for tasks critical to survival.

We suggest that these four components rely on at least two major core behavioral-motivational processes: reward and formation of affiliative memories. More specifically, human trait affiliation is proposed to rely on (a) an underlying capacity to experience reward elicited by affiliative stimuli, as reflected in the subjective emotional state assessed in trait measures of affiliation; and (b) the establish-

ment of conditioned preferences for specific individuals, which is dependent on a reward capacity and is reflected in the close interpersonal preferences tapped by trait measures of affiliation. The outcome of these integrated processes is the development and maintenance of longer-term affective bonds. We now describe these two core processes in more detail.

4.1. Reward processes across two phases of affiliation

Affiliative bonding is a critical process for infants having relatively long developmental periods, because they will not survive without intense, prolonged support from parents. Indeed, such processes developed to the greatest extent in birds and mammals, and are surmised to have been functional in the therapsids, their common ancestor which survived until 150 million years ago (Insel & Winslow 1998). Therefore, at the very least, a behavioral process is required to assure maternal bonding to infant, as well as infant bonding to mother in species with developmental periods that fully extend into offspring locomotion. This may be one reason that females have a greater disposition to express attachment-caregiving behavior than males (Taylor et al. 2000). Furthermore, although mother–infant bonding most likely represents the initial pressure for the development of affiliative bonding, in species in which the father's contribution to familial nourishment and protection is required, paternal bonding to infants and mates would also be advantageous.

If the mother–infant pair is used as the prototypic affiliative bonding condition, the most basic process that would contribute to the formation of bonds is one in which specific classes of stimuli inherently activate reward in both mother and infant, thereby motivating contact and performance of critical affiliative behaviors such as nursing (Di Chiara & North 1992). Tactile stimulation may be particularly effective in activating affiliative reward processes, as it induces the strongest reinforcement in rat mothers exposed to pups (Fleming et al. 1994). Despite the display of maternal behavior, without tactile sensation either on the ventrum or the snout, conditioned place preference, which involves the pairing of context with reward, does not develop as a result of exposure to pups (Fleming et al. 1994; Morgan et al. 1992; Stern 1990). Exposure of maternal dams to visual, auditory, or olfactory pup cues is not sufficient to establish conditioned place preference, whereas licking or touching is a necessary sensory input (Fleming et al. 1994). In humans, many forms of sensory stimulation are likely to promote bond formation, although tactile stimulation does potentially release several important sociosexually-related hormones (see sect. 6). Significantly, light, pleasant touch, that occurs to caress, like skin-to-skin contact between individuals, is transmitted by different afferents than hard or unpleasant touch (Olausson et al. 2002). Light, pleasant touch is transmitted by slow-conducting unmyelinated tactile afferents that project to the insular cortex but not to somatosensory areas S1 and S2, whereas hard, unpleasant touch is transmitted by fast-conducting myelinated afferents to S1 and S2. The insular cortex is a paralimbic region known to integrate several sensory modalities, including autonomic, gustatory, visual, auditory, and somatosensory, in order to characterize the emotional nature of sensory input (Damasio 1999; Mesulam 1990).

As illustrated in Figure 3, reward involves several dynamically interacting neurobehavioral processes occurring

across two phases of affiliation: appetitive and consummatory. Although both phases are elicited by unconditioned affiliative stimuli, their temporal onset, behavioral manifestations, and putative neural systems differ (Berridge 1999; Blackburn et al. 1989; Depue & Collins 1999; Di Chiara & North 1992; Ikemoto & Panksepp 1996; Robinson & Berridge 1993; van Furth et al. 1994; Wyvell & Berridge 2000), and are dissociated in factor analytic studies based on behavioral characteristics of animals (Pfaus et al. 1999).

4.1.1. Appetitive phase. An appetitive, preparatory phase of affiliation is based on a mammalian behavioral system, which from an evolutionary biology perspective represents a behavior pattern that evolved to adapt to stimuli critical for survival and species preservation (Gray 1973; MacLean 1986; Panksepp 1986; Schneirla 1959; Timberlake & Silva 1995). Linkage of behavioral systems to critical stimulus conditions suggests that their neurobiology is integrated with brain networks responsible for both the recognition of stimulus significance and the activation of effector systems (locomotor, facial, vocal, autonomic, hormonal). Collectively, this group of interrelated brain functions is referred to as emotion (LeDoux 1987; 1998). Thus, behavioral systems are fundamentally emotional systems that incorporate a motivational state and emotional experience that is concordant with the reinforcement properties of critical stimuli (Gray 1973; Rolls 1999).

One behavioral system is activated by, and serves to bring an animal in contact with, unconditioned and conditioned rewarding incentive stimuli (Depue & Collins 1999; Gray 1973; Hebb 1949; Koob et al. 1993; Panksepp 1986; Schneirla 1959; Stewart et al. 1984). This system is consistently described in all animals across phylogeny (Hebb 1949; Schneirla 1959), but has been defined at two conceptual levels: (a) the behavioral level, as a search (MacLean 1986), foraging (Panksepp 1986), and approach system (Gray 1973; Schneirla 1959); and (b) the underlying process, as an incentive (Depue & Collins 1999), expectancy (Panksepp 1986), preparatory (Blackburn et al. 1989), and activation system (Fowles 1987; Gray 1973; 1992). We define this system as *behavioral approach based on incentive motivation* (Depue & Collins 1999). Incentive motivation theory concerns how goal-directed behavior is elicited and guided by the perception of incentive stimuli, or central representations of those stimuli, in interaction with the central drive states of the organism, such as hunger (Bindra 1978; Panksepp 1986; Toates 1986). Incentive motivation may involve aversive or pleasant stimulus contexts, but we will refer only to the latter, given the positive affective nature of affiliative bonding.

The appetitive phase of affiliation represents the first step toward attaining biologically important goals (Blackburn et al. 1989; Hilliard et al. 1998). Specific, *distal* affiliative stimuli of potential bonding partners – such as facial features and smiles, friendly vocalizations and gestures, and bodily features (Porges 1998) – serve as unconditioned incentive stimuli based on their distinct patterns of sensory properties, such as smell, color, shape, and temperature (Di Chiara & North, 1992; Hilliard et al., 1998). For example, Breiter et al. (2001) and Aharon et al. (2001) have shown that even passive viewing of attractive female faces unconditionally activates the anatomical areas that integrate reward, incentive motivation, and approach in heterosexual males. These incentives are inherently evaluated as positive in valence (the magnitude of which likely varies with cultural differences in

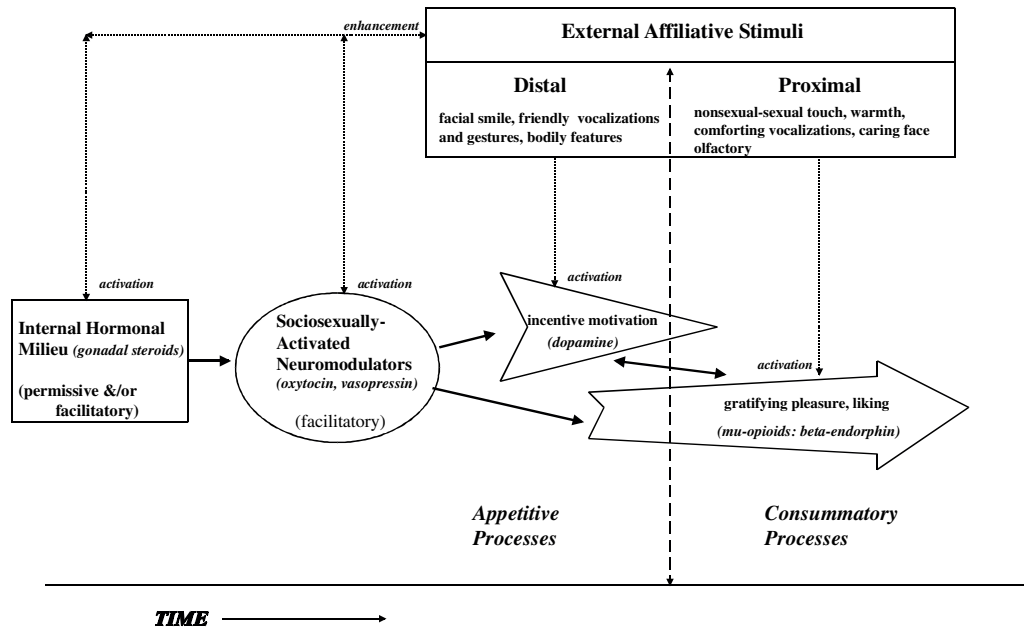

Figure 3. The development and maintenance of affiliative bonds across two phases of reward. Distal affiliative stimuli elicit an incentive-motivated approach to an affiliative goal, accompanied by strong emotional-motivational feelings of wanting, desire, and positive activation. The approach phase not only ensures sociosexual interaction with an affiliative object, but also acquisition of a memory ensemble or network of the context in which approach, reward, and goal acquisition occur. Next, proximal affiliative stimuli emanating from interaction with the affiliative object elicit strong feelings of consummatory reward, liking, and physiological quiescence, all of which become associated with these stimuli, as well as the context predictive of reward. Dopamine encodes the incentive salience of contextual stimuli predictive of reward during the approach phase and, in collaboration with μ -opiate mediated consummatory reward, encodes the incentive salience of proximal stimuli directly linked to the affiliative object. The end result of this sequence of processes is an incentive-encoded affiliative memory network that continues to motivate approach toward and interaction with the affiliative object. Specialized processes ensure that affiliative stimuli are weighted as significant elements in the contextual ensembles representing affiliative memory networks. These specialized processes include the construction of a contextual ensemble via affiliative stimulus-induced opiate potentiation of dopamine processes, and the influence of permissive and/or facilitatory factors, such as gonadal steroids, oxytocin, and vasopressin on (i) sensory, perceptual, and attentional processing of affiliative stimuli and (ii) formation of social memories. See text for details.

what is attractive), and activate incentive motivation, increased energy through sympathetic nervous system activity, and forward locomotion as a means of bringing individuals into close proximity (Di Chiara & North 1992). Moreover, the incentive state is inherently rewarding, but in a highly activated manner, and animals will work intensively to obtain that reward without evidence of satiety (Depue & Collins 1999). In humans, the incentive state is associated with subjective feelings of desire, wanting, excitement, elation, enthusiasm, energy, potency, and self-efficacy that are distinct from, but typically co-occur with, feelings of pleasure and liking (Berridge 1999; MacLean 1986; Robinson & Berridge 1993; Watson & Tellegen 1985).

4.1.2. Consummatory phase. When close proximity to a rewarding goal is achieved, the incentive-motivational approach gives way to a consummatory phase of affiliation (Herbert 1993). In this phase, specific *interoceptive* and *proximal exteroceptive* stimuli related to critical primary biological aims elicit behavioral patterns that are relatively specific to those conditions (e.g., sexual, social, or food-related) (Blackburn et al. 1989; Hilliard et al. 1998; MacLean 1986; McNaughton 1989; Panksepp 1986; Timberlake & Silva 1995). These behavioral patterns have relatively fixed topographies and immediate objectives, and are highly specialized for direct interaction with the specific stimuli associated with the biological goal. Performance of these be-

havioral patterns is inherently rewarding (Berridge 1999). Affiliation examples are courtship, gentle stroking and grooming, mating, and certain maternal patterns such as breastfeeding, all of which may include facial, caressive tactile, gestural, and certain vocal behaviors (Polan & Hofer 1998). Indeed, rat pups find physical contact with the mother inherently rewarding (Hofer et al. 1989).

As opposed to an incentive motivational state of activation, desire, and wanting, the expression of consummatory behavioral patterns elicits intense feelings of pleasure, gratification, and liking, plus physiological quiescence characterized by rest, sedation, anabolism, and parasympathetic nervous system activity, thereby reinforcing the production and repetition of those behaviors (Berridge 1999; Di Chiara & North 1992; Porges 1998; 2001; Robinson & Berridge 1993; Uvnas-Moberg 1997). Uvnas-Moberg (1997) suggested that the relaxation and satiety effects induced by activation of sensory neurons during the consummatory phase of social behavior likely evolved from a response pattern originally elicited by benign physical or chemical influences from the environment. The relaxation and sedation of the breastfeeding mother or of pups lying close together could therefore be related to the satiety and sedation induced by the intake of a meal or simply to pleasantly warm surroundings. Furthermore, both the pleasurable feelings and physiologic quiescence may serve an important feedback status. For example, in human mothers the pleasurable

feelings resulting from interactions with their infants (e.g., nursing) inform them that the behaviors they are engaging in are benefiting their offspring and contribute to their survival (Panksepp et al. 1994; Porges 1998; 2001). Thus, whereas appetitive approach processes bring an individual into contact with unconditioned incentive stimuli, consummatory processes bring behavior to a gratifying conclusion (Hilliard et al. 1998). Whether the pleasurable state generated in affiliative interactions shares a common neurobiology with the pleasure generated by other consummatory behaviors (e.g., feeding) is not certain, but it is assumed by some to be so (Di Chiara & North 1992; Ikemoto & Panksepp 1996; Panksepp 1998; van Furth et al. 1994).

4.2. Formation of affiliative memories

Through Pavlovian associative learning, the experience of reward generated throughout appetitive and consummatory phases is associated with previously affectively-neutral stimulus contexts (objects, acts, events, places) in which pleasure occurred, thereby forming conditioned incentive stimuli that are predictive of reward, and that have gained the capacity to elicit anticipatory pleasure and incentive motivation (Berridge 1999; Bindra 1978; Ostrowski 1998; Timberlake & Silva 1995). Because of the predominance of symbolic (conditioned) processes in guiding human behavior in the absence of unconditioned stimuli, conditioned incentives are likely to be particularly important elicitors of *enduring* reward processes that underlie the trait of affiliation (Fowles 1987). Indeed, Pavlovian conditioning has been demonstrated in various aspects of sexual behavior, maternal lactation, and infant suckling, and may be similarly involved in social play and social grooming (Domjan et al. 2000). Similarly, the acquisition and maintenance of human partner preference, a marker used in animal work as an indication of affiliative bonding between mates (Insel 1997), also depends closely on Pavlovian associative learning between a mate's individualistic cues and reward.

The association of a salient context with reward is complex and involves at least three different but integrated processes. They are specified here because they are modeled neurobiologically later in our discussion. First, context includes distinctive attributes of incentive stimuli (modality, size, color, scent, texture, etc.) as well as their immediate sensory surround (position, location of targets of action, etc.), both of which are integrated with respect to internal drive states, desirability of action, and intended actions in the near future. Affiliative behavior is guided by both exteroceptive and interoceptive (e.g., visceral feelings, Porges 1998; 2001) sensory cues that are present during approach to and interaction with affiliative objects. For instance, in both human sexual and maternal exchanges the participating individuals often inspect each other closely, thereby enhancing tactile sensations, odors, vocalizations, and physical recognition cues (Cruz & Del Cerro 1998). Thus, in view of the enormous number of external and internal contextual cues associated with affiliative behavior, a critical process in constructing the context of reward is neural binding, whereby the elementary bits of contextual information are compressed and bound together into a *contextual ensemble* that is predictive of reward.

Second, the specific contextual stimuli that are selected for inclusion in an ensemble must be weighted or enhanced as a function of the target class of stimuli that currently de-

fine the behavioral goal. In a sociosexual context, it is advantageous relative to other sensory cues to weight affiliative stimuli as particularly salient elements of the total context as a means of *ensuring their incorporation in contextual ensembles*. Third, the contextual ensemble must also be encoded with incentive value proportional to the magnitude of reward experienced. This process imparts a relative motivational value to the contextual ensemble, thereby scaling its modulatory influence on affective and behavioral responses elicited subsequently by those conditioned incentive stimuli. Thus, subsequent perception of this particular contextual ensemble (or salient components of it), or activation of central representations of that ensemble, elicits an incentive motivational state proportional to the encoded incentive salience of the ensemble.

Taken together, these processes support acquisition of affiliative memories, whereby contextual ensembles are formed and weighted in association with the reward provided by interaction with the affiliative object (infant, mate, parent, close friends). Because many brain regions are involved in these processes, affiliative memories are represented as a network of nodes and connections among various brain regions (LeDoux 1998; McGaugh 2000; Schacter 1996). Thus, affiliative memories may be elicited by various elements of the salient context (if such elements are sufficiently strong to activate the entire network of connections), and then serve to motivate and guide the individual to the affiliative goal.

5. Hierarchical structure of an affiliation trait

Higher-order personality traits can be modeled in a hierarchical structure for affiliation, shown in Figure 4. This structure illustrates the interrelations among affiliative stimuli and the characteristics and core underlying processes of trait affiliation discussed in Sections 3 and 4. As illustrated in Figure 4, the higher-order trait of affiliation is defined by its core underlying processes of affiliative reward, emotional experience, physiological quiescence, and formation of affiliative contextual memories. We believe that the capacity to experience affiliative reward is the *sine qua non* of the higher-order trait, because other core underlying processes depend on it (e.g., emotional experience and formation of affiliative memories). Activation of the underlying processes leads in varying degrees to behaviors associated with *intimate social engagement*. In Figure 4, lower-order traits are each associated with the higher-order trait of affiliation, because each lower-order trait reflects the influence of the processes underlying the higher-order trait. Some of the lower-order traits, such as warm, affectionate, sympathetic, and positive emotion, reflect underlying processes more directly (e.g., emotional experience is the subjective expression of reward and physiological quiescence processes), whereas others reflect their influence as manifested in affiliative contexts (e.g., agreeable, sociable, and amiable). Not shown in Figure 4, but illustrated in Figure 3, are the permissive and facilitatory modulators of the core processes underlying trait affiliation.

6. Neurobehavioral foundation of the core processes underlying trait affiliation

Our discussion has attempted to delineate the behavioral-emotional characteristics underlying a human trait of affil-

AFFILIATION TRAIT MODEL

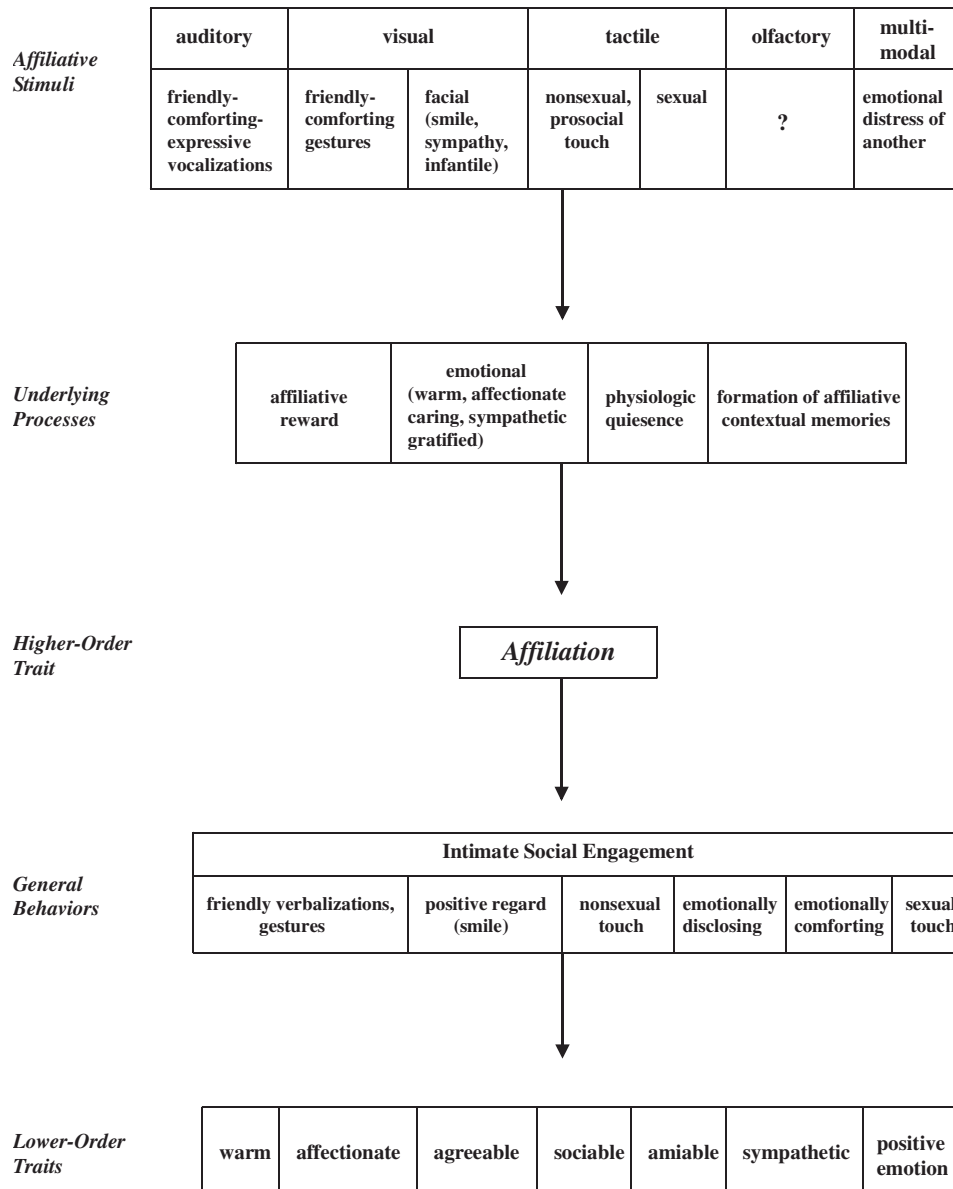

Figure 4. Path diagram representing the hierarchical structure of affiliation, which illustrates the interrelations among affiliative stimuli and the characteristics and core underlying processes of trait affiliation. See text for details.

iation, which at its core is characterized by emotional feelings of warmth and affection and valuing close interpersonal relations. We have suggested that these characteristics reflect an underlying capacity to experience reward elicited by affiliative stimuli, a capacity that allows for the development of contextual associative memory networks that establish and maintain affiliative bonds. The development and maintenance of affiliative bonds was organized within a sequence of two phases of reward in Figure 3. In section 6.1, we explore the neurobehavioral processes that are associated with these two phases of reward. In section 6.1.1, the role of dopamine neurotransmission in appetitive incentive reward processes is detailed, whereas in section 6.1.2, the role of opiates in the consummatory phase of reward is reviewed. A major component of the experience of

reward in the consummatory phase is physiological quiescence that follows consummatory behavior. In section 6.1.3, we outline the brain structures involved in physiological quiescence and comment on the role of opiates in modulating the activity of those structures.

6.1. Neurobehavioral processes of reward across two phases of affiliation

6.1.1. Dopamine, appetitive processes, and incentive reward. As reviewed recently (Depue & Collins 1999), animal research demonstrates that the positive incentive motivation and experience of reward that underlies a behavioral system of approach is dependent on the functional properties of the ventral tegmental area (VTA)

dopamine (DA) projection system. DA agonists or antagonists in the VTA or nucleus accumbens (NAS), which is a major terminal area of VTA DA projections, in rats and monkeys facilitate or markedly impair, respectively, a broad array of incentive motivated behaviors, including locomotor activity to novelty and food; exploratory, aggressive, affiliative, and sexual behavior; acquisition and maintenance of approach and active avoidance behavior; food-hoarding; and maternal nursing behavior. More specifically, DA agonists injected in the NAS reduce, whereas both DA D₁ and D₂ antagonists increase, the threshold for electrical intracranial self-stimulation reward, a response model of incentive motivation (Bozarth 1987; Everitt & Robbins 1992; Fibiger & Phillips 1987; Knapp & Kornetsky 1994; Koob et al. 1993; Le Moal & Simon 1991; Mogenson et al. 1993). Furthermore, dose-dependent DA D₁, D₂, and D₃ receptor activation in the VTA-NAS pathway facilitates the acute rewarding effects of stimulants, and the NAS is a particularly strong site for intracranial self-administration of DA agonists (Hoebel et al. 1983; Le Moal & Simon 1991; Pich et al. 1997). More recent evidence suggests that the D₁ receptor may be most critical for the rewarding effects of cocaine and specifically its euphoric effects in humans (Koob 1999; Romach et al. 1999). D₁ and D₂ agonists injected in the NAS also modulate behavioral responses to *conditioned* incentive stimuli in a dose-dependent fashion (Cador et al. 1991; Robbins et al. 1989; Wolterink et al. 1989). Conversely, DA lesions (using the DA neurotoxin 6-OHDA with terminal field ablations of 95% or more) in the NAS or VTA create a reduction in motivation to work for reward, extinction-like responding, and long-lasting reductions in self-administration of stimulants (Caine & Koob 1993; Fibiger & Phillips 1987; Koob 1992; Koob et al. 1993; Phillips & Fibiger 1978; Pich et al. 1997; Robledo et al. 1992), whereas lesions of other DA terminal fields affect stimulant self-administration very little, if at all (Roberts & Zito 1987). In single-unit recording studies, VTA DA neurons are activated preferentially by appetitive incentive stimuli (Mirenowicz & Schultz 1996; Schultz et al. 1995b; 1997). DA cells, most numerous in the VTA, respond vigorously to and in proportion to the magnitude of both conditioned and unconditioned incentive stimuli and in anticipation of reward (Bowman et al. 1996; Henriksen & Giacchino 1993; Houk et al. 1995; Koob et al. 1993; Le Moal & Simon 1991; Mark et al. 1991; Mitchell & Gratton 1992a; Mirenowicz & Schultz 1996; Nishino et al. 1987; Pfau et al. 1990; Schultz et al. 1993; Schultz et al. 1995b; Schultz et al. 1997; Weiss et al. 1992).

Finally, incentive motivation is associated in humans with both positive *emotional* feelings, such as elation and euphoria, and *motivational* feelings of desire, wanting, craving, potency, and self-efficacy. In humans, DA-activating psychostimulant drugs induce both sets of feelings (Drevets et al. 2001; Koob et al. 1993; Stewart et al. 1984). Also, neuroimaging studies of cocaine addicts found that during acute administration the intensity of a subject's subjective euphoria increased in a dose-dependent manner in proportion to cocaine binding to the DA uptake transporter (and hence DA levels) in the striatum (Volkow et al. 1997). Moreover, cocaine-induced activity in the NAS was linked equally strongly (if not more strongly) to motivational feelings of desire, wanting, and craving, as to the emotional experience of euphoric rush (Breiter et al. 1997). And the degree of amphetamine-induced DA release in healthy

human ventral striatum assessed by PET was correlated strongly with feelings of euphoria (Drevets et al. 2001). Hence, taken together, the animal and human evidence demonstrates that the VTA DA–NAS pathway is a primary neural circuit for incentive reward.

6.1.2. Opiates, consummatory processes, and reward.

A broad range of evidence suggests a role for endogenous opiates in sociosexual behavior. Endogenous opiate release or receptor binding is increased in rats, monkeys, and humans by parturition, lactation and nursing, sexual activity, vaginocervical stimulation, maternal social interaction, brief social isolation, and grooming and other nonsexual tactile stimulation such as play (Insel 1992; Keverne 1996; Keverne et al. 1989; Mansour et al. 1988; Nelson & Panksepp 1998; Niesink et al. 1996; Nissen et al. 1998; Olson et al. 1997; Silk et al. 2003; Vanderschuren et al. 1995). Moreover, the opiate receptor (OR) agonist morphine versus the OR antagonists naltrexone or naloxone increase or reduce, respectively, the ability of vaginocervical stimulation to induce maternal behavior and mother–infant bonds in sheep and humans (Keverne 1996), as well as time spent by juvenile rats with their mothers after a brief separation – indicating that opiates modulate the reward value of mothers (Agmo et al. 1997). Naloxone or naltrexone in small doses apparently reduces the reward derived from social interactions, because these substances increase attempts to obtain such reward, manifested as increases in (a) the amount of maternal contact by young monkeys, and (b) solicitations for grooming and frequency of being groomed in mature female monkeys, which has been associated with increased cerebrospinal fluid levels of β -endorphin (Graves et al. 2002; Keverne et al. 1989; Martel et al. 1995). Also, even prenatally administered morphine increases the frequency of subsequent play behavior in juvenile rats (Niesink et al. 1996). In addition, the endogenous opiate β -endorphin stimulates play behavior and grooming in juvenile rats, whereas naltrexone leads to reduced grooming of infants and other group members in monkeys and rats, and to maternal neglect in monkeys and sheep that is similar to the neglect shown by human mothers who abuse opiates (Kendrick & Keverne 1989; Keverne 1996; Martel et al. 1993; Niesink & van Ree 1989). Similarly, human females administered the opiate antagonist naltrexone showed an increased amount of time spent alone, a reduced amount of time spent with friends, and a reduced frequency and pleasantness of their social interactions relative to placebo (Jamner & Leigh 1999). Such findings suggest that opiates provide a critical part of the neural basis on which primate sociality has evolved (Keverne et al. 1989; Nelson & Panksepp 1998; Panksepp et al. 1994). Particularly important is the relation between *u*-opiates and grooming, because the primary function of primate grooming may well be to establish and maintain social bonds, which are subsequently used to act jointly on whatever environmental challenges occur (Matheson & Bernstein 2000).

Effects of opiate drugs are mediated by at least three OR families, having as many as nine subtypes (i.e., mu, delta, and kappa), and opiate peptides, as well as opiate alkaloids, may bind to more than one opiate-receptor subtype (Khachaturian et al. 1993; Mansour et al. 1988; Olson et al. 1997; Schlaepfer et al. 1998; Simon & Gioannini 1993; Stefano et al. 2000; Strand 1999; Uhl et al. 1999; Zubieta et al. 2001). Perhaps most relevant to sociosexual behavior is the

μ (μ) opiate receptor (μ OR) family, which is the main site of exogenously administered opiate drugs (e.g., morphine), of endogenous endorphins (particularly *B*-endorphin), and whose u_3 receptor subtype may be the receptor for the newly discovered endogenous morphine (La Buda et al. 2000; Mathes et al. 1996; Olson et al. 1997; Schlaepfer et al. 1998; Shippenberg & Elmer 1998; Sora et al. 1997; Stefano et al. 1996; 2000; Stefano & Scharer 1994; Wiedenmayer & Barr 2000). *u*ORs also appear to be the main site for the effects of endogenous β -endorphins and endogenous morphine on the subjective feelings in humans of *increased* interpersonal warmth, euphoria, well-being, and peaceful calmness, as well as of *decreased* elation, energy, and incentive motivation (Cleeland et al. 1996; Ferrante 1996; Greenwald et al. 1996; Olson et al. 1997; Schlaepfer et al. 1998; Shippenberg & Elmer 1998; Stefano et al. 2000; Uhl et al. 1999). The delta (δ)OR family may also be important in sociosexual behavior, in that *B*-endorphin also displays affinity for these receptors (Raynor et al. 1994; Shippenberg & Elmer 1998).

The facilitatory effects of opiates on sociosexual behavior are thought to be exerted by fibers that arise mainly from the hypothalamic arcuate nucleus and terminate in brain regions that typically express ORs, such as brainstem, basal ganglia, and corticolimbic regions, as well as in hypothalamic nuclei where the neurons of other sociosexually-related neuropeptides reside (e.g., oxytocin, vasopressin) (Brown et al. 2000; Keverne 1996; Mansour et al. 1988; Shippenberg & Elmer 1998; Stefano et al. 2000; Strand 1999). Endogenous opiate *B*-endorphin neurons located in the medial basal arcuate nucleus of the hypothalamus project anteriorly to the dorsomedial and anterior hypothalamus, medial preoptic area (mPOA), septum, diagonal band, NAS, and bed nucleus of the stria terminalis (Herbert 1993; Mann et al. 1991; Strand 1999). There are also lateral projections to the amygdala, most prominently to the central and medial nuclei, with less dense projections to the basolateral nuclei (Herbert 1993). Furthermore, there are dorsal projections that terminate in the paraventricular nuclei of the thalamus, which then proceed caudally to the brainstem periaquiductal gray (PAG), reticular formation nuclei, and nucleus of the solitary tract and other areas related to visceral and autonomic activity (Herbert 1993). Similarly, in postmortem examination of human brains, high, *u*OR concentrations were observed in the cingulate gyrus, NAS, VTA, cerebellum, thalamus, hypothalamus, mPOA, PAG, and raphe nuclei (Schlaepfer et al. 1998; Wellmann et al. 1997). Evidence for the functional importance of opiates in human limbic areas was demonstrated by Schlaepfer et al. (1998), who showed, using brain imaging, that *u*OR agonists increase regional CBF in the anterior cingulate cortex, pericentral cortex, the amygdala, and thalamus.

*u*ORs and perhaps *d*ORs may facilitate the rewarding effects associated with many motivated behaviors (Agmo & Berenfeld 1990; Agmo & Gomez 1993; Blake et al. 1987; Bozarth 1994; Keverne 1996; Koob & Le Moal 1997; Koob et al. 1993; Nelson & Panksepp 1998; Niesink et al. 1996; Olive et al. 2001; Olson et al. 1997; Stefano et al. 2000; Strand 1999; van Furth et al. 1994). For example, whereas DA antagonists block appetitive behaviors in pursuit of reward, but not the actual consumption of reward (e.g., sucrose; Ikemoto & Panksepp 1996), *u*OR-antagonists block rewarding effects of sucrose and sexual behavior, and in neonatal rats persistently impair the response to the inher-

ently rewarding properties of novel stimulation (Herz 1998). Rewarding properties of *u*OR agonists are directly indicated by the fact that animals will work for the prototypical *u*-agonists morphine and heroin, and that they are dose-dependently self-administered in animals and humans (Di Chiara 1995; Nelson & Panksepp 1998; Olson et al. 1997; Shippenberg & Elmer 1998; Wise 1996). There is a significant correlation between an agonist's affinity at the *u*OR and the dose that maintains maximal rates of drug self-administration behavior (Shippenberg & Elmer 1998). Conversely, *u*OR antagonists can lead to extinction of self-administration of *u*OR agonists, but often lead to increased self-administration of *u*OR agonists, mimicking self-administration behavior seen when the unit dose of agonist is decreased (Shippenberg & Elmer 1998).

The rewarding effect of opiates may be especially mediated by *u*ORs and to a lesser extent by *d*ORs located in the NAS and VTA, both of which support self-administration of *u*OR agonists that is attenuated by intracranially administered *u*OR antagonists (Davis & Cazala 2000; Duvauchelle et al. 1996; Herz 1998; Koob 1992; Koob & Le Moal 1997; Schlaepfer et al. 1998; Shippenberg & Elmer 1998). Opiate mechanisms in the amygdala, extended amygdala, lateral hypothalamus, and PAG also likely contribute to rewarding properties of drugs of abuse such as ethanol (Heyser et al. 1999; Shippenberg & Elmer 1998). Particularly in the rostral shell region of the NAS, DA agonists (ethanol, cocaine, d-amphetamine) administered intraperitoneally in rats markedly increased the extracellular levels of endogenous endorphins (Olive et al. 2001), whereas intracerebroventricular administration of *B*-endorphin enhances NAS DA release (Spanagel et al. 1991). Moreover, *u*-opiate reward is markedly enhanced in DA D3 receptor knockout mice (Narita et al. 2003), a receptor that contributes to the postsynaptically inhibitory modulation of the mesolimbic DA pathway. Whereas these findings suggest an interaction with DA in the rewarding effects of opiates, when opiate and mixed DA, D1, or D2 specific antagonists were given prior to cocaine or heroin self-administration, the opiate antagonist selectively altered opiate self-administration, while DA antagonists selectively altered the response to the DA agonist cocaine (Ettenberg et al. 1982; Gerber & Wise 1989; Gerrits et al. 1994; Shippenberg & Elmer 1998). Destruction of DA terminals in the NAS via the regional administration of 6-hydroxydopamine (OHDA) also showed that opiate self-administration is independent of DA function, at least at the level of the NAS (Dworkin et al. 1988; Pettit et al. 1984; Smith et al. 1985). Furthermore, NAS DA functioning was specifically related to the incentive salience of reward cues, but was unrelated to the hedonic state generated by consuming the rewards or response reinforcement (Wyvell & Berridge 2000). *Thus, DA and opiates appear to functionally interact in the NAS, but they apparently provide independent contributions to rewarding effects.* This appears to be particularly the case for the *acute* rewarding effects of opiates, which are thought to occur through a DA-independent system that is mediated through brainstem reward circuits, including the tegmental pedunculopontine nucleus (Laviolette et al. 2004; Olmstead et al. 1999).

Rewarding effects of opiates are also directly indicated by the fact that a range of μ OR agonists, including morphine, heroin, DAMGO, and *B*-endorphin, when injected intracerebroventricularly or directly into the NAS, serve as

unconditioned rewarding stimuli in a dose-dependent manner by producing a conditioned place preference, a behavioral measure of reward (Bals-Kubik et al. 1993; Carr et al. 1989; Mucha et al. 1982; Narita et al. 2000; Nelson & Panksepp 1998; Olds 1982; Olson et al. 1997; Shippenberg & Elmer 1998; van der Kooy et al. 1982). In the VTA, *u*ORs predominate, although self-administration of *d*OR agonists in the VTA has been demonstrated (Shippenberg & Herz 1988). VTA-localized *u*ORs, particularly in the rostral zone of the VTA (Carlezon et al. 2000), mediate: (a) rewarding effects such as self-administration behavior and conditioned place preference (Bozarth 1994; Carlezon et al. 2000; Panagis et al. 1998; Ramsey et al. 1999; Shippenberg & Elmer 1998; Wise 1998); (b) increased sexual activity and maternal behaviors (Callahan et al. 1996; Leyton & Stewart 1992; van Furth & van Ree 1996); and (c) the persistently increased play behavior, social grooming, and social approach of rats subjected to morphine in utero (Hol et al. 1996). Indeed, microinjections of morphine or the selective *u*OR agonist DAMGO into but not around the VTA produced marked place preferences, whereas selective antagonism of *u*ORs prevented morphine-induced conditioned place preference (Olmstead & Franklin 1997). *u*OR and *d*OR antagonists also attenuate psychostimulant-induced conditioned place preference (Houdi et al. 1989; Menkens et al. 1992; Shippenberg & Elmer 1998; Suzuki et al. 1994; Trujillo et al. 1991). Indeed, transgenic mice lacking the *u*OR gene show no morphine-induced place preferences or physical dependence from morphine consumption, whereas morphine induces both of these behaviors in wild-type mice (Matthes et al. 1996; Simonin et al. 1998). And significantly, opiate, but not oxytocin, antagonists block the development of partner preference that is induced specifically by repeated exposure and repeated sexual activity in rodents (Carter et al. 1997).

Taken together, these results indicate that activation of VTA *u*ORs (with perhaps *d*ORs) is sufficient for the establishment of place conditioning (Bals-Kubik et al. 1993; Baumeister et al. 1993; Bozarth 1987). These VTA *u*OR-mediated conditioning effects, however, are dependent on DA D1, but not D2, receptor activation in the NAS, as is *B*-endorphin-facilitated grooming in rodents (Drago et al. 1999). 6-OHDA lesions of DA terminals in the NAS, or infusion into the NAS, but not the caudate-putamen, region of selective DA D1 receptor antagonists during place conditioning, resulted in prevention or dose-related attenuation of the conditioned response to systemically administered morphine, respectively (Shippenberg & Elmer 1998). Activation of the DA D3 receptor, which may be an autoreceptor in the VTA and thereby inhibit activation of DA release in the NAS, also prevents the acquisition of morphine-induced place conditioning (DeFonseca et al. 1995). Whereas *u*OR agonists administered in the NAS do not elevate responding for conditioned reward, they do sensitize DA receptor reactivity to DA agonists in the NAS (Cunningham & Kelley 1992). The reason for opiate dependence on NAS D1 receptor activation in place conditioning is discussed in section 6.2.1.6

An interaction of DA and *u*-opiates, discussed further in section 6.3.2, in the experience of reward throughout appetitive and consummatory phases of affiliative engagement appears to involve two processes. During the anticipatory phase of goal acquisition, *u*OR activation in the VTA can increase DA release in the NAS, and hence the experi-

ence of reward (Bozarth 1994; Callahan et al. 1996; Jaeger & van der Kooy 1996; Marinelli & White 2000; Olson et al. 1997; Panagis et al. 1998). Subsequently, the firing rate of VTA neurons decreases following delivery and consumption of appetitive reinforcers (e.g., food, sex, liquid) (Kosobud et al. 1994; Schultz et al. 1997). At the same time, *u*OR and *d*OR (Churchill et al. 1995) activation in the NAS (perhaps by opiate release from higher-threshold NAS terminals that colocalize DA and opiates [Le Moal & Simon 1991]) decreases NAS DA release, creating an opiate-mediated experience of reward associated with consummation that is independent of DA. Thus, in contrast to the incentive motivational effects of DA during the anticipation of reward, opiates may subsequently induce calm pleasure and bring consummatory behavior to a gratifying conclusion (Bozarth 1994). This may explain the fact that higher doses of both *u*OR and *d*OR agonists administered into the NAS can block the self-administration of certain psychostimulant drugs of abuse in animals and reduce appetitive behaviors (Amalric et al. 1987; Corrigan & Vaccarino 1988; Heyser et al. 1999; Hyztia & Kiianmaa 2001; Johnson & Ait-Daoud 2000; Kelley et al. 1996; Kranzler 2000).

Although beyond the main focus of our discussion, *u*ORs are also the main site for the supraspinal antinociceptive systems, because mice lacking *d*ORs and kappa (*k*) ORs exhibit analgesia in response to morphine (Simonin et al. 1998; Stefano et al. 2000; Zubieta et al. 2001). Analgesic effects, however, may be mediated by different *u*ORs or different ligands of *u*ORs than rewarding effects (Wilson et al. 2000). Nelson and Panksepp (1998) creatively suggest that an analgesic function of *u*ORs is based on tactile (touch) elicitation of opiates as a means of reducing pain-induced emotional distress (Reisine & Pasternak 1996; Zubieta et al. 2001), and that this tactile-opiate relation was conserved throughout evolution to incorporate other opiate-induced functions by gentle touch, such as reduction of separation-induced emotional distress, and reward and physiological calming during prosocial engagement. Recent research supports this notion (Eisenberger et al. 2003).

6.1.3. Opiates, consummatory processes, and physiological quiescence. The consummatory phase of reward is typically accompanied by a state of physiological quiescence and behavioral calmness that contributes to the subjective feelings of liking and pleasure (Berridge 1999; Wyvell & Berridge 2000). Porges (1998; 2001) has integrated the literature on neural processes that contribute to physiological quiescence in mammals and especially primates, processes that he views as important components of social engagement, communication, and affiliative bonding. In particular, the more recently evolved myelinated efferents from ventral vagal neurons in mammals, arising from visceromotor portions of the nucleus ambiguus located in the rostral ventrolateral medulla, are capable of providing rapid inhibitory regulation of the autonomic nervous system, supradiaphragmatic visceral organs, and the sinoatrial node of the heart, as well as of striated musculature involved in facial and vocal communication. This vagal *brake* conserves biological resources by allowing for rapid changes in sympathetic tone without widespread autonomic nervous system and adrenal endocrine activation.

In addition, primates in particular can rapidly regulate sympathetic and adrenal activity via prefrontal regions (see review by Sullivan & Gratton 2002). Anterior cingulate and

dorsal prefrontal cortex in primates have a particularly dense distribution of glucocorticoid (type II) receptors that detect phasic changes in circulating cortisol levels. Activation of type II receptors in these regions engages an inhibitory feedback mechanism that modulates further hypothalamic-pituitary-adrenal cortex (HPA) stress responsivity (but not basal levels). Thus, in nonthreatening, nonstressful contexts, these prefrontal areas provide strong inhibitory regulation of rat right-hemispheric ventral infralimbic cortex (homologous to right hemispheric ventral orbital cortex in humans), a region that provides strong activation of sympathetic and adrenal activity (Sullivan & Gratton 2002). Under repeated stressful conditions, the ventral orbital cortex, proposed to sit at the apex of a stress response system (Schore 1996; 1997), activates sympathetic and adrenal activity via projections to the HPA axis, the lateral hypothalamic region controlling sympathetic activity, and the rostral ventrolateral medullary zone for integration of arousal information. But of importance here is that, under conditions of social engagement, dorsal prefrontal inhibition of ventral orbital cortex, together with ventral vagal output (Porges 2001), can jointly create a state of physiological quiescence and behavioral calm that promotes prosocial interactions and consummatory processes.

*u*ORs may facilitate this state of physiological quiescence and behavioral calm, although additional functional studies are required. A parallel distribution of endogenous morphine and the *u*OR gene is found in the PAG, rostral ventrolateral medulla, parabrachial nuclei, and locus coeruleus (Stefano et al. 2000). In the area of the rostral ventrolateral medulla, this parallel distribution occurred in the nucleus paragiganticocellularis, which is a major integration zone for arousal information and that provides the major source of activation to: (a) the autonomic nervous system, and (b) to locus coeruleus neurons, which in turn induce central arousal via norepinephrine release (Aston-Jones et al. 1996; Davis et al. 1996). Indeed, disinhibition of the locus coeruleus cells is implicated in the excessive arousal that accompanies the opiate withdrawal syndrome (Legradi et al. 1996). Furthermore, *B*-endorphin neurons in the medial basal arcuate nucleus of the hypothalamus send dorsal projections that terminate in the paraventricular nuclei of the hypothalamus, which then proceed caudally to the brainstem PAG, reticular formation nuclei, and nucleus of the solitary tract and other areas related to visceral and autonomic activity (Herbert 1993). Moreover, in the human brain, high *u*OR and endogenous opioid concentrations were observed in the anterior cingulate gyrus, NAS, VTA, amygdala, hypothalamus, mPOA, PAG, and raphe nuclei (Price 1999; Price et al. 1996; Schlaepfer et al. 1998; Stefano et al. 2000; Strand 1999; Wellmann et al. 1997).

The simultaneous presence of endogenous opiates and the *u*OR gene in these regions is consistent with the ability of opiate alkaloids to alter autonomic and neuroendocrine responses (Krzanowska et al. 1998; Stefano et al. 2000; Willis & Westlund 1997). In addition, their joint presence in both the anterior cingulate gyrus, which can inhibit ventral orbital activation of stress responses, and in the paraventricular hypothalamus, which is the site of corticotrophin-releasing hormone and the initiation of subsequent cortisol release, could also modulate sympathetic and adrenal activity. Although this modulation of arousal effector systems is utilized as part of an analgesic response system, it is also utilized to induce physiological quiescence at

the time of consummatory behavior. Subsequently, the calming, inhibitory effects of endogenous morphine are diminished in a relatively short period of time, because *u*OR desensitization occurs once downregulation of physiological arousal is achieved, even while endogenous opiates are still present in the internal environment (Stefano et al. 2000). This timely recovery of neural processes involved with opiate actions provides for a successful mechanism to ensure survival.

Physiological quiescence in the consummatory phase may also be promoted by serotonin, which, for example, when released into the anterior lateral hypothalamus during the postejaculatory interval in male rats, directly decreases the preejaculatory increase in NAS DA via disinhibition of inhibitory efferents from the lateral hypothalamus to the NAS (Lorrain et al. 1999), an inhibitory effect that may extend to other appetitive behaviors facilitated by NAS DA, such as feeding (Aoyagi et al. 1992; Schwartz et al. 1989). Serotonergic-induced decreases in autonomic arousal via raphe input to the arousal integration zone in the lateral hypothalamus (Depue & Spont 1986; Spont 1992) may also promote calm, prosocial interactions, such as allogrooming in vervet monkeys and positive social interaction in young adult humans, both of which are positively associated with increased serotonin activity (Insel & Winslow 1998).

In sum, as illustrated in Figure 3, distal affiliative cues (e.g., friendly smiles and gestures, sexual features) serve as incentive stimuli that activate DA-facilitated incentive-reward motivation, desire, wanting, and approach to affiliative objects. As these objects are reached, more proximal affiliative stimuli (e.g., pleasant touch) strongly activate *u*-opiate release, which promotes an intense state of pleasant reward, warmth, affection, and physiological quiescence, and brings approach behavior to a gratifying conclusion. These two different types of reward processes are critical to the acquisition and maintenance of learned associations between the context accompanying the approach to and consummation of affiliative objects, or put differently, of affiliative memories. It is to the neurobiology of this formation of social memories that we now turn.

6.2. Formation of affiliative memories

In addition to the processes of reward, we have proposed that affiliation involves the formation of affiliative memories, wherein contexts predictive of affiliative reward are associated with that reward. Although highly complex, the manner in which context is bound to reward processes in appetitive and consummatory phases of reward to form memories is beginning to be elucidated in the animal neurobiology literature. We address this issue in detail in section 6.2.1. To illustrate these processes, it is necessary first to understand the brain structures that process the contextual elements that comprise an affiliative memory, and these are briefly outlined in sections 6.2.1.1–6.2.1.4, wherein special attention is devoted to the integrative nature of the nucleus accumbens in the ventral striatum. The manner in which these brain regions form an organized network is equally important and is reviewed in section 6.2.1.5. With that background, the discussion then focuses on: (a) the specific manner in which the contextual elements associated with reward are bound together to form a contextual ensemble, and (b) how that ensemble is encoded for in-

centive salience. These points are reviewed in section 6.2.1.6, wherein the critical roles of dopamine and glutamate are described. Because of the complexity of the discussion in section 6, a summary of the major points is outlined in section 6.2.1.7. Finally, in section 6.2.1.8, evidence supporting the necessary role of dopamine in the formation of *affiliative* memories, in particular, is reviewed.

6.2.1. Dopamine's role in acquiring environmental context-incentive motivational ensembles. The critical role of the VTA DA-NAS pathway in the facilitation of incentive motivation suggests that the NAS is a site of integration of incentive information. The caudomedial shell region of the NAS (NASshell) is a major point of convergence of motivational information from many corticolimbic structures (Deutch et al. 1993; Heimer et al. 1993; Kalivas et al. 1993; Wilson & Kawaguchi 1996; Wright et al. 1996). Whereas NAS cells decrease firing during periods of focused attention and consummatory events, they increase firing to primary and conditioned signals of reward and novelty, during intervals when reward is expected, and during engagement in rewarding social activity (Apicella et al. 1991; Henriksen & Giacchino 1993; Le Moal & Simon 1991; Schultz et al. 1992; Schultz et al. 1995a). Responses of NAS neurons to salient contextual stimuli are due to afferent excitatory stimulation arising from at least four main sources, all of which are interconnected (Kalivas et al. 1993), but each provides different information about the salient incentive context.

6.2.1.1. Basolateral complex of the amygdala. The basolateral amygdala (i.e., the basal, accessory basal, mediobasal, and lateral nuclei) of the rat (Wright et al. 1996) and monkey (Heimer et al. 1993) provides massive, topographically organized, compartmentally bounded innervation of the NASshell. In both monkeys and humans, the basolateral amygdala plays a critical role in classical stimulus-reinforcement conditioning, the process whereby neutral cues acquire positive and negative incentive status and emotional meaning (Aggleton 2000; Bechara et al. 1995; Cahill & McGaugh 1990; 1998; Emery & Amaral 2000; Everitt & Robbins 1992; Gaffan 1992; LeDoux et al. 1990; Selden et al. 1991). Although the basolateral amygdala has often been viewed as associating negative emotions with reinforcement, recent evidence supports a role for the amygdala in processing positive emotions as well as negative ones, including the learning of stimulus-reward associations (Baxter & Murray 2002; Gottfried et al. 2003). Bilateral basolateral amygdala lesions specifically impair the association of *discrete, explicit* stimuli with reinforcement (as opposed to nonexplicit, contextual stimuli – see sect. 6.2.1.2), whereas the *motivational efficacy* or incentive magnitude of food rewards or of DA injections in the NAS remains intact (Aggleton 1992; Everitt & Robbins 1992; Gaffan 1992). The basolateral amygdala can enhance DA release in the NAS, but this release is under inhibitory control from prefrontal efferents to the NAS (Jackson & Moghaddam 2001). The amygdala provides associative processes for *affiliative* stimuli, because complete amygdala lesions in primates cause a decline in affiliative behavior, social communication, and emotional responses to other animals, which is thought to result from an inability to emotionally interpret complex affiliative stimuli (i.e., to associate them with affective meaning) (Emery & Amaral 2000; Steklis & Kling

1985). More specifically, lesions of the basolateral amygdala prevent induction of conditioned place preference in environments that have been paired with rat pups, and also impair postpartum maternal behaviors to such stimuli (Fleming et al. 1999). And female rats develop increased activity in the basolateral amygdala with increasing exposure to their pups (Fleming et al. 1999).

6.2.1.2. Extended amygdala. Basolateral and olfactory amygdala complexes send massive projections to a group of structures collectively referred to as the extended amygdala, which represents a macrostructure that is characterized by two divisions, central and medial (Heimer 2003; Heimer et al. 1993; Martin et al. 1991; McGinty 1999). Originating from the central and medial nuclei of the amygdala and traversing through the subnucleus area and bed nucleus of the stria terminalis (BNST), the central and medial divisions merge specifically with the caudomedial region of the NASshell (see Fig. 5). Many intrinsic connections occur along these divisions, particularly in the central division, suggesting that high-level integration occurs within the extended amygdala (Heimer 2003; Heimer et al. 1993; Koob & Le Moal 1997; LeDoux 1998). Pharmacological and lesion manipulations of all central extended amygdala structures modify incentive motivation to work for rewards and initiation of locomotor activity as a means of obtaining rewards (Heimer et al. 1993; Kalivas et al. 1993; Koob 1992; Koob et al. 1993). Similar to the outputs from the central nucleus of the amygdala, most structures of the central division of the extended amygdala can transmit this motivationally relevant information to some or all hypothalamic and brainstem structures related to emotional expression (Heimer 2003; Heimer et al. 1993; Holstege 1991; 1992). Whereas the basolateral complex of the amygdala is involved in pairing reinforcement with stimuli that are discrete and explicit and that have been analyzed for their specific characteristics, at least the central division of the extended amygdala appears to associate *general contextual features and nonexplicit, nondiscrete* conditioned and unconditioned stimuli with reinforcement (e.g., light conditions, physical features, spatial relations) (Davis et al. 1997; Davis & Shi 1999; Koob et al. 1993; McDonald et al. 1999). Thus, two emotional learning systems may have evolved: (1) the basolateral amygdala to associate reinforcement with explicit, specific characteristics of objects (a property of the ventral visual stream and auditory feature analysis), and (2) the BNST to associate reinforcement with nonexplicit spatial and contextual stimulus aspects (as in the dorsal visual stream and spatial location of auditory stimuli) (Karnath 2001).

6.2.1.3. Hippocampus. The hippocampus topographically innervates the NASshell (Groenewegen et al. 1991), but lesions of the fimbria-formix or ventral hippocampus do not impair the association of *discrete* stimuli with reinforcement (Bechara et al. 1995; Gaffan 1992). Rather, hippocampal, but not basolateral amygdala, lesions disrupt Pavlovian associations formed between the *spatial and contextual interrelations* of environmental stimuli and reinforcement (Annett et al. 1989; Davis & Shi 1999; Davis et al. 1997; Selden et al. 1991; Sutherland & McDonald 1990; Winocur 1997). In part, this may be the result of inputs carrying spatial and contextual information from the hippocampus and parahippocampal cortex to the BNST (Davis

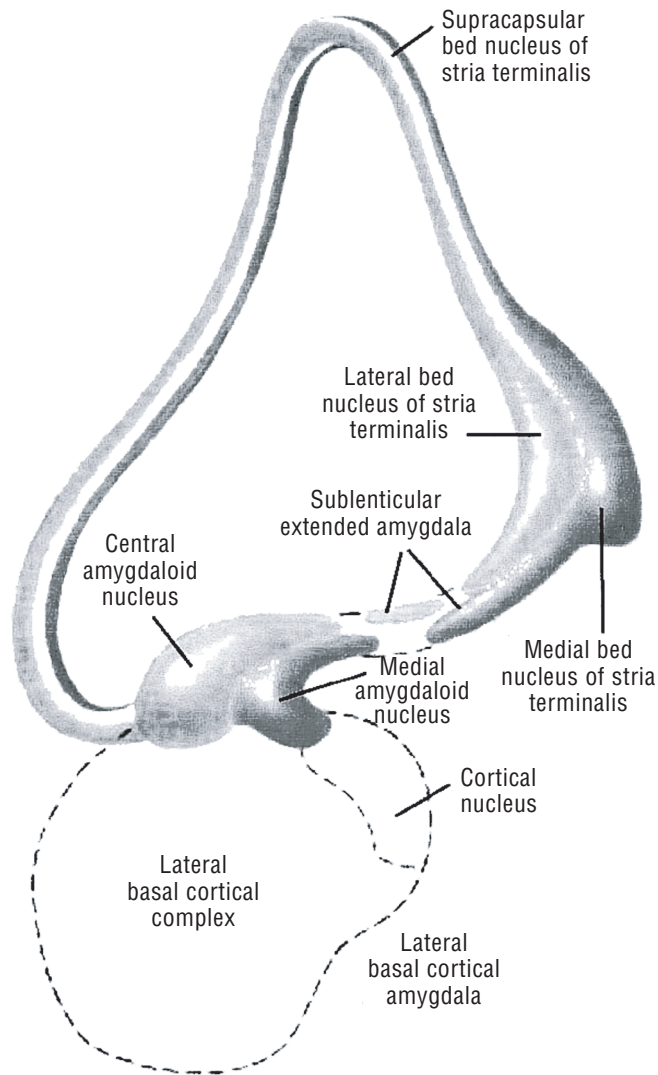

Figure 5. The central and medial divisions of the extended amygdala, shown in isolation from the rest of the brain. From Heimer 2003.

& Shi 1999; Davis et al. 1997). NAS lesions, on the other hand, can produce behavioral deficits closely related to those following impairment of hippocampal functions (Annett et al. 1989). Thus, doubly dissociable limbic-striatal functions (amygdala-NAS vs. hippocampal-NAS) may correspond to the compartmentalization of the NAS (Everitt & Robbins 1992; Gaffan 1992).

6.2.1.4. Prefrontal cortex. The orbital frontal cortex, particularly Brodmann's posterior medial orbital prefrontal cortical area 13 (MOC I3), integrates the most complex level of associations of reinforcement with both stimuli and responses (Adolphs 2003; Bechara et al. 1997; Gottfried et al. 2003; Rolls 2000; Schneider 2003; Thorpe et al. 1983). Via connections with more laterally located orbital cortical circuits, MOC I3 has strong connectivity with regions that process all sensory modalities of contemporaneous and stored information, as well as topographically organized efferents that densely innervate the NASshell (Barbas 1995; Deutch et al. 1993; Goldman-Rakic 1987; Kalivas et al. 1993; Ongur & Price 2000; Price 1999). Through its dense reciprocal connections with the basolateral, central, and ex-

tended amygdala regions, MOC I3 has access to emotional and reinforcement associations of contemporaneous and recalled sensory events (Carmichael & Price 1995; Drevets 2001; Elliott et al. 1997; Gallagher et al. 1999; Goldman-Rakic 1987; Hikosaka & Watanabe 2000; O'Doherty et al. 2001; Rolls 1999; 2000; Schneider et al. 2000; Tremblay & Schultz 1999). MOC I3 forms higher-level conditional representations of sensory events by associating them with existing or newly developing response-reinforcement contingencies; or more simply, MOC I3 may abstract an integrated structure of appetitive and aversive behavioral contingencies from the environment (Frey & Petrides 2000; O'Doherty et al. 2001; Rogers et al. 1999; Rolls 2000; Schneider 2003; Thorpe et al. 1983). When behavioral responses evoke unexpected reinforcement outcomes, MOC I3, in collaboration with the basolateral amygdala (Everitt & Robbins 1992; Gottfried et al. 2003) and hippocampus (Gray et al. 1991), encodes the new contingencies that are relevant to the modification of response programs (O'Doherty et al. 2001; Rolls 2000; Schneider 2003; Thorpe et al. 1983). MOC I3 may be capable of holding such representations of behavioral-reinforcement contingencies in working memory as motor strategies are selected over time (Damasio 1999; Goldman-Rakic 1987; O'Doherty et al. 2001; Rolls 1999; 2000; Scalaide et al. 1997). This capacity would allow a comparison of the valence and magnitude of outcome expectancies associated with several possible response strategies, and then an updating of contingencies as circumstances unfold during the temporal duration of the selected response strategy (Depue & Collins 1999; Houk et al. 1995).

Because our focus is on affiliation, it is worth noting that the basolateral amygdala, BNST, and MOC I3 receive neural input from cortical regions associated particularly with the processing of faces and biological motion. Such information is relevant to judgments about others emotions, attractiveness, intentionality, friendliness and approachability, and interpersonal personality traits. These cortical regions would include: (a) the fusiform gyrus in processing the structural, static properties of faces, and (b) more anterior and dorsal regions in the temporal lobe (e.g., the superior temporal gyrus and sulcus) involved in processing the changeable configurations of faces (e.g., facial expressions) and biological motion of the whole body and body parts (gaze shifts and arm, hand, and mouth movements) (Adolphs 2003). Additionally, neural input about light, pleasant touch, and autonomic status from the insular cortex is also substantial to these areas. Thus, areas that encode the incentive salience of contextual stimuli have access to a range of cues relevant to affiliative interactions.

6.2.1.5. Neural organization of incentive-facilitated behavior in a medial orbital network. Together, these brain regions just discussed provide a wealth of contextual information to the NASshell that must be integrated. Many complex motor, cognitive, and motivational processes are integrated via networks of brain regions that have a directed flow of information from cortical areas through striatal, pallidal, and thalamic regions back to one of the originating cortical areas, typically within the prefrontal cortex (Alexander et al. 1990). The purpose of these networks (or reentrant circuits) is to develop a neural ensemble, derived from thousands of elements, that serves as an integrated representation of movement, cognition, or motivation (Graybiel 1997;

1998), a representation that may be stored in memory as a network of interconnected nodes (Graybiel 1995; Jog et al. 1999; Kelley 1999a; McGaugh 2000; O'Donnell 1999; O'Donnell et al. 1999; Schacter 1996).

Kalivas et al. (1993) proposed that incentive context and reward associations, which are integrated in the basolateral and extended amygdala and MOC, are translated into an incentive motivational state within a *motive circuit* (Kalivas et al. 1993). The circuit includes the NASshell, ventromedial subterritory of the ventral pallidum (VPm), and VTA DA ascending projections (see lower half of Fig. 6). All three regions are strongly, reciprocally, and preferentially connected with each other, as compared to other subregions of the striatum and pallidum (Deutch et al. 1993; Heimer et al. 1993). Functionally, these regions are interdependent in that the rewarding self-administration of electrical stimulation and stimulant drugs, as well as the initiation of locomotor activity, can be elicited from all three regions (Kalivas et al. 1993; Klitenick et al. 1992; Koob et al. 1993).

One major function of the integration of information in the NASshell is to encode the motivational *intensity* or *saliency* of incentive stimuli (Kalivas et al. 1993; Robinson & Berridge 1993). As shown in Figure 6, this current motivational code established in the motive circuit can be transmitted from VPm to MOC 13 via the mediodorsal (MD) nucleus of the thalamus (Deutch et al. 1993; Groenewegen

1988; Groenewegen et al. 1999a; 1999b). Presumably, this code is merged with the most current representation of behavioral-reinforcement contingencies held in working memory by MOC 13, perhaps invoking a reintegration that reflects a change in motivational state (Damasio 1999; Depue & Collins 1999; Houk et al. 1995). The result of this processing would be a continual iterative updating, not only of incentive motivational intensity as integrated in the motive circuit, but also of reinforcement priorities and behavioral outcome expectations constructed in MOC 13.

Thus, a broad network of distributed neural structures is implicated in the modulatory influence of incentive motivation on appetitive behavior. Extending the ideas of others (Deutch et al. 1993; Groenewegen et al. 1990; 1991; 1999a; 1999b; Heimer 2003; Heimer et al. 1993; Kalivas et al. 1993), we proposed an MOC network illustrated in Figure 6 (Depue & Collins 1999). In keeping with the structure of other network models (Alexander et al. 1990; Goldman-Rakic 1987; Groenewegen et al. 1990; 1991; 1999a; 1999b; Mesulam 1990), the origin and termination site of this network lies within the prefrontal cortex, specifically MOC 13. Connections among all components of the network are topographically organized (Groenewegen et al. 1990; 1991; 1999a; 1999b), indicating that the basal ganglia-thalamo-cortical circuits of the ventral forebrain are congruent with the structure of more dorsally located cortical circuits outlined by Alexander et al. (1990). The MOC network incor-

Corticolimbic-Striatal Circuit for Acquisition of Context - Incentive Motivation Ensemble

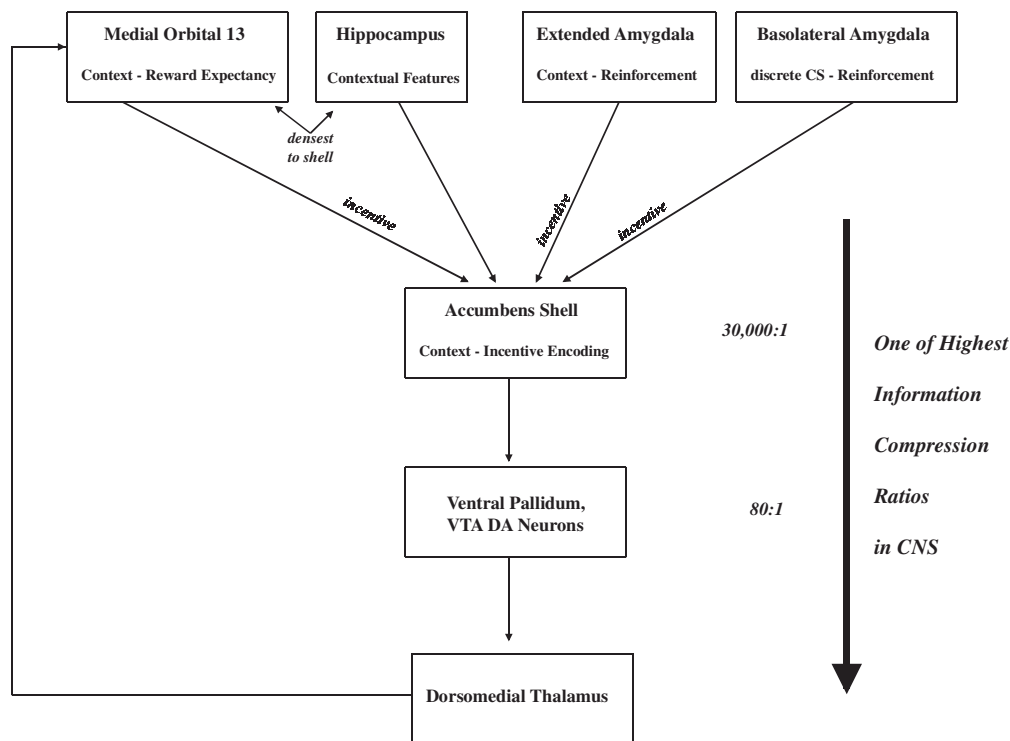

Figure 6. A schematic illustration of a medial orbital prefrontal cortical (MOC) network. Corticolimbic regions convey various types of contextual information to the NASshell in a ratio of 30,000:1 (there are 30,000 corticolimbic inputs to each NASshell spiny neuron dendrite), where information is bound into a contextual ensemble and encoded for incentive saliency or value. There is a further compression of the ensemble as it is transferred from the NAS to the ventral pallidum in a ratio of 80:1. The ensemble is transmitted via the dorsomedial thalamus to the ventral prefrontal region of Brodmann's medial orbital 13, where it is merged with the highest representation of environmental reward contingencies and used to regulate incentive-motivational modulation of goal-directed behavior. See text for details. (Abbreviations: VTA = ventral tegmental area; DA = dopamine).

porates three basic components: (1) a motive circuit, which integrates, maintains, and updates information to form an intensity-encoded incentive motivational state, (2) the VTA DA projection system, which facilitates the neural integration occurring in the motive circuit, as well as within network interactions more generally (Depue & Collins 1999), and (3) MOC 13, which performs higher-order regulation of network processes, which is consistent with similar proposals regarding the rat ventral prefrontal cortex (Deutch et al. 1993; Kalivas et al. 1993; Thorpe et al. 1983; Watanabe 1990).

6.2.1.6. Formation of a contextual ensemble in the MOC network: DA–glutamate interactions. The MOC network provides incentive-related contextual information that needs to be integrated (Heimer 2003). As shown in Figure 6, in one of the highest information compression ratios in the central nervous system (CNS) (Graybiel 1998; O'Donnell 1999), corticolimbic regions in the MOC network send approximately 30,000 afferents to each medium spiny neuron in the NASshell (more densely to the NASshell than to any other striatal region; Groenewegen et al. 1999a; 1999b), thereby binding that information into neural ensembles encoded for incentive magnitude or salience (Graybiel 1998; Jog et al. 1999; Kelley 1999a; 1999b; O'Donnell 1999; O'Donnell et al. 1999). Further compression occurs in the flow of information from the NAS to the ventral pallidum (in an 80:1 ratio) and then to the dorsomedial thalamus. The final contextual ensemble is transmitted to MOC 13, where it is represented at its highest level in association with reward expectancies (Goldman-Rakic 1987; Kalivas et al. 1999; O'Donnell 1999; O'Donnell et al. 1999; Schoenbaum et al. 1998; Thorpe et al. 1983; Watanabe 1990).

But just how is a contextual ensemble formed? The acquisition of contextual ensembles is strongly dependent on DA facilitation in the NASshell (Aosaki et al. 1994; Depue & Collins 1999; Everitt et al. 1999; Graybiel 1998; Jog et al. 1999; Meredith & Totterdell 1999; O'Donnell 1999; White 1997; Wickens et al. 1996). Brain regions carrying contextual information (right side of Figure 7) innervate the heads of dendritic spines of NASshell projection neurons using glutamate as a transmitter, and most of these efferents are excitatory to NAS function and are reciprocated (Calabresi et al. 1996; Christie et al. 1987; Davis 1992; Dudai 1989; Fuller et al. 1987; Goldman-Rakic 1987; Groenewegen et al. 1990; 1999a; 1999b; Groves et al. 1995; Houk et al. 1995; Kalivas et al. 1993; 1995; McGinty 1999; Meredith et al. 1993; Pierce et al. 1996; Schultz et al. 1995b; Sesack & Pickel 1990; 1992; Takagishi & Chiba 1991; Wickens & Kotter 1995). In addition, approximately 8,000 VTA DA projections also innervate the dendritic shaft or spinal necks of each NAS spiny neuron (Groves et al. 1995; Grace 1991; Meredith et al. 1993; O'Donnell 1999; O'Donnell et al. 1999; Schultz et al. 1995b; Sesack & Pickel 1990; 1992). As illustrated in detail only at the proximal level of the dendrite for basolateral amygdala input (but occurring at all other input levels as well), glutamate and DA can substantially increase release of each other via *N*-methyl-D-aspartate (NMDA) and D1 receptors, respectively, located on terminals (Berretta & Jones 1996; Calabresi et al. 1996; 1997; Chowdhury & Fillenz 1991; Gracy & Pickel 1996; Groenewegen et al. 1999a; 1999b; Kalivas 1995; Krebs et al. 1991; Liste et al. 1995; Lu et al. 1997; McGinty 1999; Nestler & Aghajanian 1997; Pierce & Kalivas 1995; 1996;

Sesack et al. 1994; Shi et al. 1999; Wickens et al. 1996; Zamanillo et al. 1999; Zhang et al. 1997).

As shown in Figure 7, a DA–glutamate interaction takes place via intracellular cascades in NAS spiny neurons, and facilitates the development of long-term potentiation (LTP) (Kelley 1999b; McGinty 1999). Indeed, such DA facilitation of glutamate release has been shown to be critical for the efficacy of glutamate via NMDA receptors to trigger LTP of amygdala and hippocampal afferents to the NAS (Bissiere et al. 2003; Groenewegen et al. 1999a; 1999b; Li et al. 2003; Malenka & Nicoll 1999; O'Donnell 1999; O'Donnell et al. 1999). This suggests that DA can affect the efficacy of corticostriatal transmission with long-term consequences that could affect striatum-based learning and memory (Graybiel 1998). Moreover, the DA–glutamate interaction at *basolateral* amygdala–NASshell synapses not only triggers LTP at those synapses, but also, because the dendritic location of the amygdala afferents is in close proximity to the soma (Groenewegen et al. 1999a; 1999b), it may have a strong depolarizing effect on the soma and proximal dendrite (see bottom part of Figure 7). This, in turn, increases the voltage-dependent effects of glutamate on NMDA receptors at more distal synapses on the dendrite arising from other contextual inputs (e.g., from MOC 13 and extended amygdala), thereby facilitating the strength of *coherently* activated input to the dendrite (associativity effects) (McGaugh 2000; Meredith & Totterdell 1999; O'Donnell 1999; O'Donnell et al. 1999). In this way, in conjunction with DA input, reward magnitude of *discrete, explicit* contextual stimuli carried by basolateral amygdala afferents to the NAS can facilitate the triggering of LTP in other contextual afferents to the NASshell (Gallagher & Holland 1994; McGaugh 2000).

Importantly, the facilitatory effect of DA on strengthening synaptic connections in the NASshell is dependent on the strength of the contextual afferent input. Lesions of the glutamatergic afferents representing contextual inputs to VTA DA or NAS regions prevent incentive-motivated responding, despite the fact that the intact VTA DA and NAS neurons are activated by a DA agonist (Dahlin et al. 1994; Kalivas 1995; Kalivas & Stewart 1991; Pert et al. 1992; Yoshikawa et al. 1991). As shown in Figure 8, DA's variation of effect as a function of strength of afferent input leads to an increased contrast between inputs (Begg et al. 1993; Houk et al. 1995; O'Donnell 1999; Schultz et al. 1995b; 1997; Wickens & Kotter 1995), and in this way appears to play an important role in selective strengthening of the corticolimbic antecedents associated with reward and with previously successful responses (Houk et al. 1995; Kalivas 1995; Pierce et al. 1996; Schultz et al. 1995b; 1997; Toshihiko et al. 1994; Wickens & Kotter 1995). Presumably, the more DA that is released in the NAS, (a) the greater the strengthening of contextual afferents on NAS dendrites, and (b) the greater the number of afferents facilitated. Hence, variation in DA input to the NAS will modulate the strength of the contextual ensemble, and hence the capacity of the ensemble to elicit incentive motivation, positive affect, and approach behavior. *This then represents the encoding by DA of incentive salience of contextual ensembles.*

The next obvious question, then, is what exactly activates DA release in the NAS so that the formation of a contextual ensemble can be facilitated? As illustrated in Figure 9, the same brain areas that provide contextual information to the NAS also provide afferent input to the VTA DA neurons,

Binding of Salient Context and Incentive Motivation in the Accumbens Shell

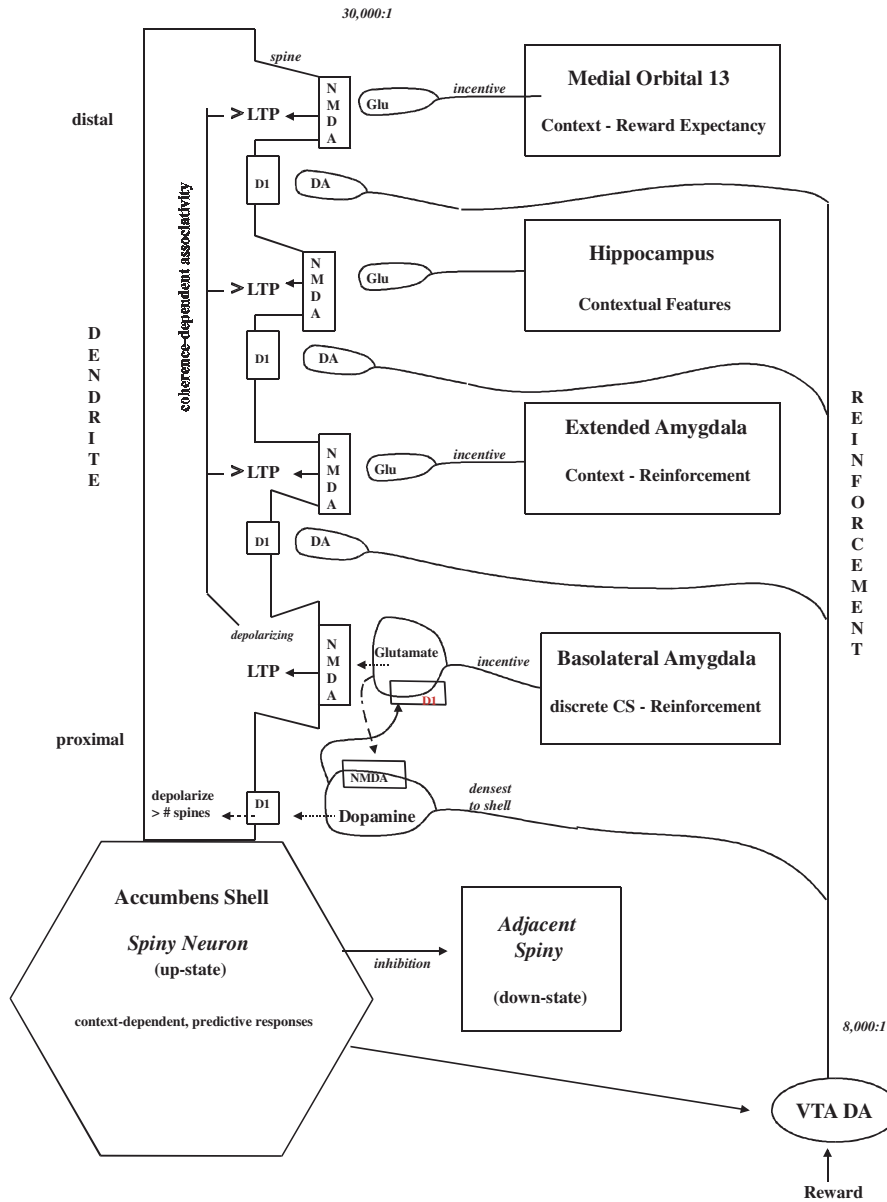

Figure 7. Binding of salient context with incentive motivation in the NASshell. The acquisition of contextual ensembles is strongly dependent on DA facilitation in the NASshell (Aosaki et al. 1994; Depue & Collins 1999; Everitt et al. 1999; Graybiel 1998; Jog et al. 1999; Meredith & Totterdell 1999; O'Donnell 1999; White 1997; Wickens et al. 1996). Corticolimbic brain regions carrying contextual information (right side of figure) innervate the heads of dendritic spines of NASshell projection neurons using glutamate as a transmitter; most of these efferents are excitatory to NAS function and are reciprocated. In addition, approximately 8,000 VTA DA projections also innervate the dendritic shaft or spinal necks of each NAS spiny neuron. As illustrated in detail only at the proximal level of the dendrite for basolateral amygdala input (but occurring at all other input levels, as well), glutamate and DA can substantially increase release of each other via NMDA and D1 receptors, respectively, located on terminals. In this way, DA is thought to strengthen the connections between inputs of the salient incentive context predictive of reward and incentive processes integrated in the NASshell. See text for details. (Abbreviations as in Figure 6, except Glu = glutamate; NMDA = N-methyl-D-aspartate glutamate receptor; LTP = long-term potentiation; D1 = D1 dopamine receptor).

thereby activating DA release in the NAS as a function of salient context. Also, direct projections from superior colliculus to midbrain DA neurons, activated by unpredicted, biologically salient stimuli, activate those DA neurons (Comoli et al. 2003). The optimal stimuli for activating VTA DA neurons are phasically occurring unpredicted unconditioned rewards, whereas fully predicted stimuli are ineffective

(Schultz et al. 1995b). This can be seen during an experiment's progression: VTA DA neurons show (a) increased activity in the presence of neutral stimuli that consistently predict reward (an activation produced by corticolimbic contextual inputs to the VTA DA neurons), and (b) a concurrent decrease in activity to the unconditioned rewards, until DA responding has transferred completely to the con-

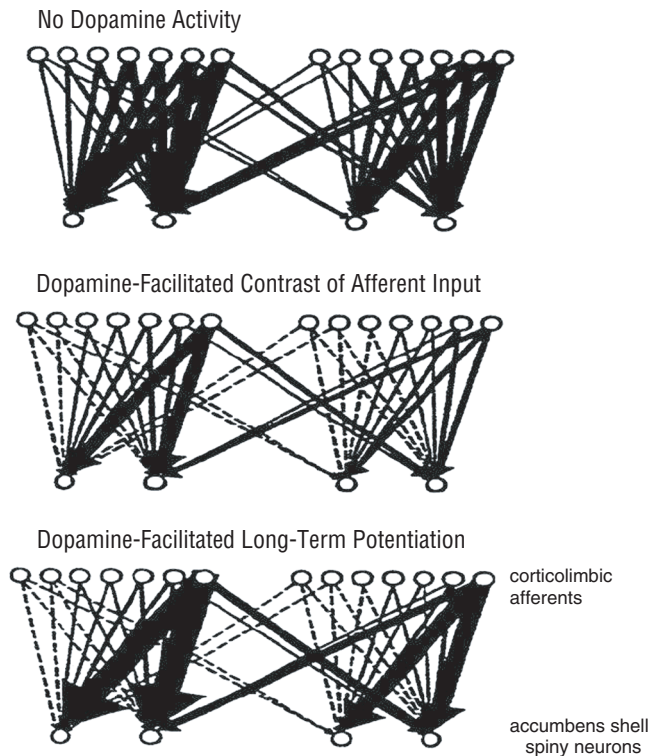

Figure 8. Progressive, differential effects of dopamine release on weak (depressing) and strong (facilitating) cortical and limbic inputs to NAS spiny neurons. At the bottom of the figure, the salient corticolimbic inputs to the NASshell have been enduringly strengthened by dopamine release via a process thought to be similar to long-lasting long-term potentiation. Adapted from Schultz et al. 1995b.

ditioned incentive stimuli (Schultz et al. 1995b; 1997). Importantly, the *orbital area* provides the major source of activation of VTA DA neurons (Carr & Sesack 2000; Taber et al. 1995), which increases the activity of VTA DA cells that project to the NASshell, central and basolateral amygdala, and VPM (Groenewegen et al. 1990; 1991; 1999a; 1999b). MOC input strongly regulates burst firing of VTA DA cells, which is associated with a doubling of DA release per action potential in the NAS (Gonon 1988; Johnson et al. 1992; Suaud-Chagny et al. 1992). Because DA release in the NASshell gates motivational information arriving from the amygdala and hippocampus (Mogenson et al. 1993), MOC regulation of VTA DA–NASshell projections has a significant impact on contextual ensemble formation. As also shown in Figure 9, orbital and other corticolimbic contextual afferent activation of VTA DA neurons is also part of the memory network of an ensemble, in that DA–glutamate interactions at synapses of these afferents on VTA DA neurons trigger NMDA-mediated L-LTP (Graybiel 1998; Kalivas & Alesdatter 1993; O'Donnell 1999; O'Donnell et al. 1999). As shown in Figure 9, this process is enhanced by the facilitatory action of somatodendritically released DA from VTA neurons onto D1 receptors on glutamate axonal terminals.

6.2.1.7. Summary. The complexity of the discussion in section 6 can be illuminated by presenting the essential elements in outline form. First, there are numerous corticolimbic brain regions, including the MOC, basolateral amygdala, extended amygdala and BNST, and hippocampus, that

serve as depositories of contextual sensory information which is processed in various brain pathways. The corticolimbic regions associate the contextual information with reinforcement and established memories, and transmit that information via glutamatergic afferents to two neural sites: (a) DA neurons in the VTA, and (b) the dendrites of spiny neurons in the NASshell.

Second, the glutamatergic corticolimbic afferents carrying contextual information, if of sufficient salience, establish an interaction with DA long-lasting, long-term potentiated connections with VTA DA neurons. It is this associative connectivity that allows contexts predictive of reward to activate VTA DA neurons to release DA into the NASshell whenever those contexts occur in the future, thereby facilitating incentive–reward motivation, desire, and approach to rewarding objects.

Third, the same corticolimbic regions that activate VTA DA neurons also send afferents to NASshell dendrites, in a ratio of approximately 30,000 inputs to each NASshell dendrite. This input is accompanied by VTA DA neuron afferents that terminate on these same NASshell dendrites. DA release in the NASshell via corticolimbic activation of VTA DA neurons facilitates connection of corticolimbic contextual inputs to NAS dendrites, where again a DA–glutamate interaction can establish long-lasting, long-term potentiation of these connections if the corticolimbic inputs are sufficiently strong. The purpose of this anatomical convergence of corticolimbic and VTA DA afferents on NASshell dendrites is to bind the thousands of elements comprising the context together to form a contextual ensemble that is predictive of reward.

Importantly, the degree of corticolimbic activation of VTA DA neurons, and hence of DA release in the NASshell, is a function of the magnitude of reward associated with the current context. Thus, magnitude of reward is encoded in each contextual ensemble by the magnitude of DA release in the NASshell. Incentive-encoded contextual ensembles provide predictive information about the probability and magnitude of reward, and, in turn, modulate affective and behavioral responses via *proportional* activation of DA functioning. Indeed, in rats DA-agonist-induced NAS DA reactivity and behavioral responding are enhanced in diffuse contexts previously associated with reward (as in place preference) (Ahmed et al. 1993; 1995; Jodogne et al. 1994; Le Moal & Simon 1991). Thus, context can substantially modulate the unconditioned response to DA agonists.

Fourth, the importance of these processes is that each context in which reward occurs is represented by a memory network that is the incentive-encoded contextual ensemble. Therefore, when multiple contexts occur either externally or as central representations in working memory (e.g., simultaneous occurrence of several affiliative objects or their central representations), the NAS operates, together with VTA DA facilitation, as a selective mechanism, allowing expression of the ensemble with the greatest incentive salience. The selected contextual ensemble (associated with one of the affiliative objects) will thus gain passage around the MOC network – from the NASshell to the ventral pallidum, mediodorsal thalamus, to the MOC 13 region. MOC 13 then uses that ensemble information to construct the most current, highest-order representation of context-behavioral outcome expectations, and accordingly activates (or releases) behavior via several pathways. As behavioral approach to the goal (one of the affiliative objects)

Contextual Binding to and Activation of VTA Dopamine Neurons

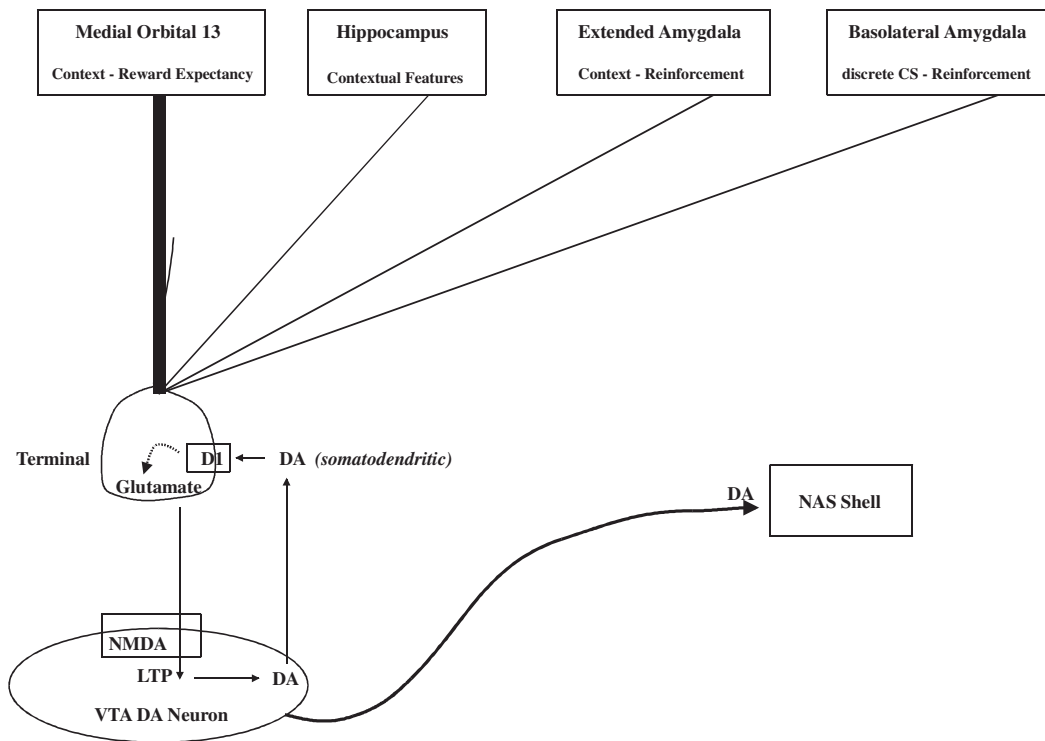

Figure 9. Contextual binding to and activation of VTA DA neurons. The same brain areas that provide contextual information to the NAS also provide afferent input to the VTA DA neurons, thereby activating DA release in the NAS as a function of context. The thicker line from Medial Orbital 13 indicates that the orbital area provides *the major source* of activation of VTA DA neurons, which increases the activity of VTA DA cells that project to the NASshell, central and basolateral amygdala, and VPm. Orbital regulation of VTA DA–NASshell projections has a significant impact on contextual ensemble formation. Orbital and other corticolimbic afferent activation of VTA DA neurons is also part of the memory network of an ensemble, in that DA–glutamate interactions at synapses of these afferents on VTA DA neurons trigger NMDA-mediated L-LTP, a process enhanced by the facilitatory action of somatodendritically-released DA from VTA neurons onto DI receptors on glutamate axonal terminals. See text for details. (Abbreviations as in Figures 6 and 7, except NASshell = nucleus accumbens shell subterritory).

proceeds, the corticolimbic-striatal-thalamic-prefrontal circuit provides a means to update the contextual ensemble that currently has the highest incentive salience (which may be the same ensemble or not), and transmits that information to MOC 13, which then constructs an updated representation of context-outcome expectations.

Fifth, during approach to the goal, VTA DA release in the NASshell provides an incentive salience code for the ensemble, creates subjective feelings of incentive, desire, and reward, and facilitates forward locomotion. As the goal (affiliative object) is reached, μ -opiate release: (a) creates a state of consummatory reward that ensures incorporation of proximal contextual stimuli in the contextual ensemble, (b) helps encode the reward value of the entire contextual ensemble, and (c) creates a pleasurable state of liking and physiological quiescence, thereby bringing incentive-motivated approach to a gratifying conclusion. The outcome of this process is the acquisition and maintenance of a reward-encoded contextual ensemble that promotes approach to and interaction with the rewarding goal. When the goal is an affiliative object, such as a mate, a partner preference is established and maintained.

6.2.1.8. Dopamine and affiliative memories. The relevance of acquisition of contextual ensembles to the development

of affiliative memories, in particular, is supported by several recent studies on the role of DA in partner preference and memory formation and consolidation. Sex serves as a potent reward in rats (Pfaff 1999; Sheffield et al. 1955), and male and female rats display mating-induced place preferences (Everitt 1990; Oldenburger et al. 1992). Interestingly, the act of mating, or even exposure to sensory stimuli from a male rat, strongly activates DA release particularly in the NAS in female and male rats and hamsters, an increase that can persist during the entire period of exposure to a male or female (Damsma et al. 1992; Lorrain et al. 1999; Meisel et al. 1993; Mermelstein & Becker 1995; Pfaff 1999; Pfaus et al. 1995; Vathy & Etgen 1989; Wenkstern et al. 1993). Mating in female prairie voles also leads to a partner preference, but the formation of the preference is time- and experience-dependent, requiring at least 14 hours of male exposure with 10–20 bouts of copulation during this interval (Insel & Hulihan 1995; Wang, Z. et al. 1999). In female prairie voles, increases of 50% in extracellular DA occurred in the NAS within 15 minutes of mating and continued to be high (by 30%) for 3 hours, and smaller increases (17% and 8%, respectively) were evident in nonestrous females simply exposed to a male, indicating that DA activation may occur as a result of both mating and social stimulus activation (Gingrich et al. 2000). In prairie voles, however, DA

does not affect the ability of males and females to perform specific mating behaviors (Wang, Z. et al. 1999). Rather, even in the absence of mating, DA agonists injected into the NAS dose-dependently facilitated the development of partner preference in female prairie voles, mimicking the effects of mating (Gingrich et al. 2000). Conversely, DA antagonists administered specifically in the NAS directly before or immediately after mating did not affect mating behavior per se, but did block the development of partner preference if administered bilaterally and if active drug levels endured for approximately 24 hours in the NAS (Gingrich et al. 2000; Insel et al. 1995; Wang, Z. et al. 1999). The need for prolonged DA antagonism is consistent with the findings of a surge of DA release with repeated mating after 12 hours of mating (Wang, Z. et al. 1999). Moreover, the fact that administration of a DA antagonist 24 hours after mating, but directly prior to the preference test, did not block partner preference suggests that DA blockade is affecting the formation and/or consolidation of the mate-reward associative memory during the first 24 hours of mating, rather than olfactory or other discrimination thresholds (Wang, Z. et al. 1999) or memory retrieval (McGaugh 2000; Schacter 1996). Together, these results suggest that DA plays a necessary role in the formation and consolidation of a mating-induced partner preference in female rodents of several species, although the results are most clear with respect to the prairie vole, in which a D2 receptor mechanism is supported (Gingrich et al. 2000; Wang, Z. et al. 1999).

Exactly which processes are being facilitated by DA during and after mating is not empirically known. One possibility is a direct effect on more basic sensory detection, which would affect affiliative recognition processes. A partner preference in female prairie voles requires olfactory detection of social cues (Williams et al. 1992), and thus DA enhancement of such sensory information may influence mate recognition processes and thereby associative phases of mate-reward association. DA plays an important role in such processes. Stimulation of the accessory olfactory system causes release of DA in the NAS (Mitchell & Gratton 1992b), and NAS DA is important for affiliative identity in male rats (Ploeger et al. 1991). In addition, D2 agonists decrease (Doty & Rissler 1989) and D1 agonists increase (Doty et al. 1998) olfactory sensitivity. However, as noted in section 6.2.1.8, the fact that administration of a DA antagonist 24 hours after mating, but directly prior to the preference test, did not block partner preference suggests that DA blockade is not affecting these more basic sensory processes per se. Rather, DA may be affecting the incorporation of the sensory information in the formation and/or consolidation of the mate-reward associative memory during the first 24 hours of mating. Thus, DA may act directly on processes involved in formation and/or consolidation of mate-reward associations comprising part of a contextual ensemble in a fashion identical to the well-established role of NAS DA in the formation of conditioned place preference (Le Moal & Simon 1991). Indeed, mating, which increases NAS DA, can induce place preference in male and female rats and in female hamsters, an effect that can be blocked by DA antagonists (Agmo & Gomez 1993; Meisel & Joppa 1994; Meisel et al. 1993; Oldenburger et al. 1992; Paredes & Alonso 1997). In sum, these studies suggest that DA plays a facilitatory role in the acquisition of mate-reward associations that is concordant with DA's role in the formation and incentive encoding of contextual ensembles in general.

6.3. Enhancing the incorporation of affiliative stimuli in contextual ensembles

The above discussion on the formation of contextual ensembles that predict reward is a generalized case. What seems important to understand, however, is the manner in which specific contextual stimuli that are selected for inclusion in an ensemble are weighted or enhanced as a function of the target class of stimuli that currently define the behavioral goal. In a sociosexual context, it is advantageous, relative to other sensory cues, to weight affiliative stimuli as particularly salient elements of the total context, as a means of ensuring their incorporation in contextual ensembles. We review several mechanisms that may provide the means for enhancing affiliative stimuli in contextual ensembles. These include: (1) a network of brain regions that appear to integrate affiliative stimuli and transfer their representation to the nucleus accumbens (the medial extended amygdala in sect. 6.3.1.), (2) the role of opiates, presumably carrying *affiliative* information, in facilitating DA and glutamate functioning in the nucleus accumbens (sect. 6.3.2), and (3) the functional roles of gonadal steroids, oxytocin, and vasopressin in perception and memory formation in the presence of affiliative stimuli (sect. 6.3.3).

6.3.1. Contribution of the medial extended amygdala. An interconnected network of brain regions integrates affiliation-relevant exteroceptive and interoceptive sensory information that modulates the expression of a host of affiliative behaviors. These regions include nuclear groups in the *medial* division of the extended amygdala (MXA, see Fig. 5), the lateral septum, mPOA, the anterior hypothalamus, the ventromedial nucleus and adjacent ventrolateral hypothalamus, and the PAG. All regions are reciprocally interconnected, have neurons that contain gonadal hormone receptors, and modulate more than one type of affiliative behavior (De Olmos & Heimer 1999; Ferguson et al. 2001; Larsson & Ahlenius 1999; McDonald et al. 1999; Newman 1999; Panksepp 1998; Pfaff 1999; Rolls 1999). Modulatory rather than strict mediating action of this network is suggested by the fact that so many affiliative behaviors are influenced by manipulations of regions in the network, including male and female courtship and sexual behaviors (sniffing, mounting, lordosis, copulation, ejaculation), maternal behavior, nest building, grooming, territorial marking, territorial aggression, mate guarding, and maternal and paternal aggression (Larsson & Ahlenius 1999; Newman 1999; Panksepp 1998; Rolls 1999). Corticolimbic regions in the network (e.g., structures of the MXA) may serve to integrate various sensory inputs for the purpose of modulating regions that integrate sociosexually-relevant neuroendocrine and autonomic functions (e.g., the mPOA-anterior hypothalamic continuum, the nuclei of the medial and lateral hypothalamus, and pituitary function), and, in turn, influence a host of social behavior patterns mediated by PAG circuits (Bandler & Keay 1996; de Olmos & Heimer 1999; Larsson & Ahlenius 1999; McDonald et al. 1999). The MXA may be particularly important in integrating contextual affiliative stimuli, and providing that representation to the NAS for integration into a comprehensive contextual ensemble related to reward. As shown in Figure 10, the MXA includes the medial amygdaloid nucleus and the medial bed nucleus of the stria terminalis, in addition to cell columns between these two structures, both within the stria

<i>Differentiation of Rostral and Caudal Medial Extended Amygdala Circuits</i>		
<i>Circuit</i>	Rostral: MeAD - SLEAv - BNSTpi	Caudal: MePD - SLEAd - BNSTpm
<i>Stimuli</i>	external olfactory & nonolfactory sensory, perceptual, contextual, affective associations	interoceptive hormonal fluctuations associated with diurnal, estrus, &/or seasonal factors
<i>Corticolimbic Afferents</i>	<p style="text-align: center;">cortical amygdala MeAD ↓ main olfactory bulb primary olfactory cortex basolateral amygdala ↓ ventrolateral entorhinal area → ventral subiculum → ventroanterior insula ↓ ↓ ↓ MeAD SLEAv BNSTpi [neurons similar to spiny neurons of striatum]</p>	<p>none discovered (primarily in this circuit that androgen & estrogen receptors exist)</p>
<i>Major Efferents</i>	nucleus accumbens paraventricular hypothalamus (OT, VP) arcuate hypothalamus (B-endorphins) medial preoptic area	anterior hypothalamus medial hypothalamus medial preoptic area
<i>Functions</i>	<ul style="list-style-type: none"> - promotes formation & activation of sociosexual components of contextual ensembles predictive of affiliative reward - facilitates release of sociosexually-activated neuropeptides 	<ul style="list-style-type: none"> - activates pituitary hormonal release

Figure 10. Differentiation of rostral and caudal medial extended amygdala circuits. See text for details and abbreviations.

terminalis and in the subpallidal or ventral sublenticular area, whereas the cortical and basolateral nuclei of the amygdala are not included (de Olmos & Heimer 1999).

There are two subdivisions within the MXA (see Fig. 10; Newman 1999): a *rostral* circuit, extending from the anterior dorsal subregion of the medial nucleus of the amygdala to the posterior intermediate BNST, including ventral aspects of the sublenticular area (MeAD–SLEAv–BNSTpi); and a *caudal* circuit, extending from the posterior dorsal subregion of the medial nucleus of the amygdala to the posterior medial BNST (MePD–SLEAd–BNSTpm). Structures in the *rostral* circuit show increased Fos protein expression in response to mating – as well as aggressive encounters in both male and female hamsters after tail pinching in rats, which enhances affiliative behaviors – but not to nonsocial motor and sensory activity alone. Lesions of the *caudal* circuit completely abolish mating (mounting,

ejaculation) and chemosensory investigation in rodents, and the behavior cannot be restored by injections of testosterone or estradiol. Therefore, this appears to be an essential circuit for the activation of various sociosexual behaviors. Also, structures in the *caudal* circuit show increased Fos protein expression specifically to chemosensory investigation or ejaculation during mating sequences, and lesions of these structures modify only the temporal pattern of mating behavior rather than the performance of the behaviors themselves. Moreover, it is primarily in the *caudal* circuit that androgen and estrogen receptors are localized, and in which testosterone or estradiol injections restore the temporal patterning of mating behaviors. Therefore, the *caudal* circuit may be strongly modulated by hormonal fluctuations associated with diurnal, estrus, and/or seasonal factors.

As summarized in Figure 10, of significance with respect to the formation of contextual ensembles, *only the rostral*

circuit structures receive corticolimbic projections, and may have cells similar to the spiny neurons of the striatum (see review by McDonald et al. 1999). Corticolimbic projections originate from the ventral subiculum and ventrolateral entorhinal area (projecting to all three areas of the circuit), the ventroanterior insular cortex (projecting to MeAD and SLEAv), and the infralimbic cortex (projecting to all three circuit areas). The rat infralimbic cortex, which is homologous to the primate medial orbital cortex (Depue & Collins 1999), is a particularly important integration region as a source of contextual input to the *rostral* circuit. The infralimbic cortex receives: (a) an array of nonolfactory sensory, perceptual, and relational contextual input from the ventral subiculum, ventrolateral entorhinal cortex, and basolateral complex of the amygdala; and (b) similar to the anterior insular cortex, olfactory contextual input directly from the primary olfactory cortex, the main olfactory bulb, and indirectly from the latter via the cortical nucleus of the amygdala and the MeAD. Furthermore, the infralimbic cortex is also a major source of information to the central division of the extended amygdala, thereby having the capacity to strongly influence activity in both divisions of the extended amygdala.

On the basis of these differential patterns of corticolimbic afferentation to the two subdivisions of the MXA, McDonald et al. (1999) concluded that, in response to mainly interoceptive hormonal signals, the *caudal* circuit is mainly involved in regulating pituitary hormonal release during sociosexual interactions via projections to the anterior and medial hypothalamus and mPOA. In contrast, the *rostral* circuit is proposed to be involved in regulating sociosexual behavior by external affiliative stimuli. We would add the possibility that such affiliative stimulus input is integrated in the structures of the *rostral* circuit, and that integrated information may then modulate circuit projections to the NASshell and to regions controlling release of sociosexually-activated neuropeptides, such as to the paraventricular nucleus of the hypothalamus, as a means of activating oxytocin and vasopressin release, as well as to the β -endorphin neurons in the arcuate nucleus and mPOA (McDonald et al. 1999). An example of how this integrated system might operate is instructive: Male rats exposed to a receptive female manifest an increase in DA release selectively in the NAS, *but only in sexually naive animals* (Larsson & Ahlenius 1999). Sexually naive animals will need to acquire a contextual ensemble that encodes sensory features of receptivity with incentive salience. According to McDonald et al.'s (1999) findings, sensory features of the receptive female are likely integrated in the *rostral* circuit, and the known projections from this circuit to the NAS may influence DA neurotransmission in the NAS, *thereby facilitating the formation of a contextual ensemble informed by affiliative stimuli* (de Olmos & Heimer 1999).

6.3.2. Contribution of opiates. We reviewed in section 6.1.2 that *u*ORs are activated strongly by affiliative stimuli, may mediate affiliative reward, and provide an unconditioned reward for establishing conditioned place and mate preferences. Facilitation of associative processes between affiliative stimuli and reward in corticolimbic structures would be critical to the process whereby stimulus characteristics of others take on positive valence. Indeed, opiate release is highly conditionable (Nelson & Panksepp 1998; Shippenberg & Elmer 1998), and this conditioned release

of opiates can be induced by stress, a finding with implications for relapse in opiate addicts (Shaham et al. 2000). For example, merely the anticipation of daily cocaine self-administration sessions resulted in increased opioid receptor occupancy in the NAS, thereby indirectly indicating increased release of opiates in the NAS (Gerrits et al. 1999). Also, in a brain imaging study of heroin-addicts (Sell et al. 1999), both heroin (unconditioned stimulus) and salient conditioned cues (video of drug paraphernalia) activated the same midbrain areas centered in the VTA DA region and PAG, both of which are rich in ORs (Koob 1992; LeGradi et al. 1996). Similar brain regions were activated in opiate addicts in response to monetary reward (Martin-Soelch et al. 2001) and in normal humans when a previously neutral visual cue acquired behavioral salience (Morris et al. 1997). Moreover, the μ OR-agonist morphine versus *u*OR-antagonist naltrexone promotes or blocks, respectively, the establishment of odor–mother and male–female recognition associations (Byrnes & Bridges 2000; Leyton & Stewart 1992; Nelson & Panksepp 1998; Panksepp 1998). Such conditioning can take place very early in development, when brain levels of opiates at birth in normal human infants are 100 times greater than those at older ages (Waterhouse et al. 1996). That opiates may provide the reward involved in mother–infant conditioning is suggested by the fact that pairing of a novel odor or taste with morphine induced a conditioned preference in 4-day-old rats, and naltrexone blocked this preference if it preceded morphine at conditioning or if it was given at test (Blass 1992; Kehoe & Boylan 1994). Similar processes appear to operate in human newborns, suggesting that newborns can extract from caretaker interactions certain features that regularly predict the delivery of a substance that causes release of endogenous opiates, and that loss of this predictive quality is disturbing, as judged by crying (Blass 1992). Thus, these *u*OR-dependent processes may play a significant role in not only the *establishment* but also the *maintenance* of long-term affiliative bonds via the facilitation of affiliative contextual ensembles. Therefore, it is an important question as to how opiates might accomplish this facilitation.

B-endorphin neurons in the medial basal arcuate nucleus have access to many corticolimbic sites that are involved in processing contextual stimuli, and their neurons are activated by the MXA, which is involved in binding sociosexual contextual stimuli (de Olmos & Heimer 1999; Larsson & Ahlenius 1999; McDonald et al. 1999). As illustrated in Figure 11, there are at least three specific ways in which opiates may act via *u*ORs to facilitate acquisition of affiliative contextual ensembles and affiliative memories. First, as shown in Figure 11a, in the NASshell and its small-celled islands, *u*ORs are localized mainly to dendrites or dendritic spines that also express type 1 NMDA receptors (NMDAR1) (Gracy & Pickel 1996; Gracy et al. 1997; Svingos et al. 1996; Voorn et al. 1996). When *u*ORs are activated by *B*-endorphin or other agonists, postsynaptic NMDA-induced currents to glutamate are potentiated, which represents the main action of *u*ORs in the NASshell (Martin et al. 1997). In the NAS and other brain regions, this form of potentiation appears to be a result of the ability of *u*OR ligands to increase postsynaptic responses to NMDA receptor stimulation through activation of both protein kinase C (PKC) and of calcium/calmodulin-dependent (CaM) kinase, and at least in the trigeminal nucleus, the enhanced responses last as long as 60 minutes after agonist washout (Chen &

Huang 1991; Kitamura et al. 1993; Mao et al. 1994; 1995; Martin et al. 1997). This effect is believed to depend on the ability of PKC to remove the Mg^{2+} block from the NMDA receptor, allowing the influx of Ca^{2+} as a trigger for the development of LTP (Chen & Huang 1991; Malenka & Nicoll 1999; McGaugh 2000). Thus, at least one population of spiny neurons in the NASshell is subject to dual modulation by μ OR and NMDAR ligands. Because B -endorphin neurons are activated by affiliative stimuli, μ OR activation in the NASshell may potentiate affiliative corticolimbic contextual inputs mediated by glutamate release on NMDAR in the NAS (Jaskiw et al. 1991).

Second, as illustrated in Figure 11b, again in the NASshell, most spiny neuron dendrites that express μ ORs without colocalized NMDAR1 receive input from axons that (a) express NMDAR1, and (b) have morphological features typical of DA afferents (Bouyer et al. 1984; Freund et al. 1984; Sesack et al. 1994). Consistent with the axonal terminals being DA afferents is that DA terminals in the NASshell do express NMDAR1 (Gracy & Pickel 1996). Moreover, DA D_1 and D_2 agonists injected into the NAS increase μ OR mRNA expression (Azaryan et al. 1996), an effect that may be a result of either (i) postsynaptic DA receptor activation-induced potentiation of μ OR response to ligands, and/or (ii) activation of presynaptic DA receptors localized on opiate afferents (see Fig. 11b) (Curran & Watson 1995). Alternatively, μ OR agonists (morphine) administered in the NAS increase NAS DA release, support conditioned place preference, and sensitize DA receptor reactivity to DA agonists in the NAS (Cunningham & Kelley 1992; Spanagel et al. 1991). This DA-opiate interaction in the NAS would thereby represent a DA-mediated potentiation of the effects of opiates on NAS dendritic μ ORs (Azaryan et al. 1996; Sharp et al. 1995). Consistent with this interaction, opiate antagonists reduce the effect of estrus female olfactory cues on DA release in the NAS (Mitchell & Gratton 1991). Thus, because B -endorphin neurons are activated by affiliative stimuli, reciprocal enhancement between u -opiate and DA afferents to NASshell dendrites would increase the probability that affiliative inputs to the dendrite become part of the contextual ensemble.

Third, as shown in Figure 11c, activation of μ ORs and d ORs localized on GABA-A interneurons in the VTA dose-dependently inhibits the GABA-induced inhibition of DA neurons – a net disinhibition of VTA DA neuron firing (Bals-Kubik et al. 1993; Johnson & North 1992; Shippenberg & Elmer 1998). This enhances VTA AMPA receptors and hence DA neuron sensitivity to glutamate, particularly VTA DA neurons projecting to the NAS, and this is a necessary component of conditioning of opiate-mediated reward (Carlezon et al. 1997; 2000; Leone et al. 1991; Zhang et al. 1997). For example, injections of morphine or the selective μ OR agonist DAMGO into the VTA, particularly its rostral zone (Carlezon et al. 2000), induce a conditioned place preference, whereas injections that are dorsal or lateral to the VTA or are placed in the amygdala, medial prefrontal cortex, lateral hypothalamus, caudate-putamen, ventral pallidum, or substantia nigra do not (Bals-Kubik et al. 1993; Shippenberg & Elmer 1998). The importance of VTA μ ORs for conditioned place preference was underscored by the prevention of morphine-induced conditioned place preference when VTA μ ORs were blocked. In any case, u -opiate-induced enhancement of VTA DA neuron reactivity to salient stimuli could have two effects related to

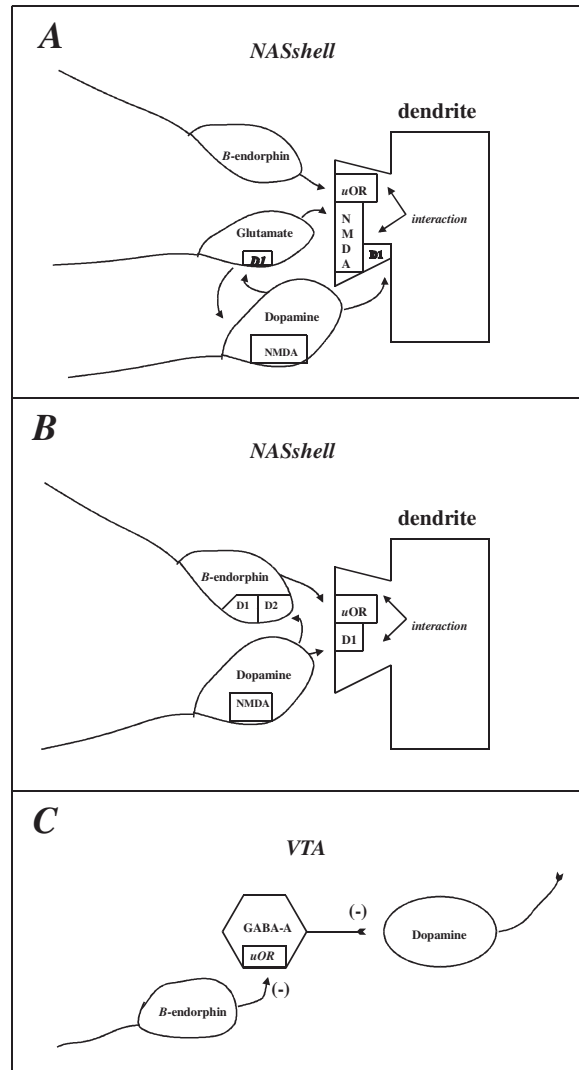

Figure 11. Dopamine and opiate interactions in the NAS and VTA. Three types of interaction are shown. Part A = in the NASshell μ ORs are localized mainly to dendrites or dendritic spines that also express type 1 NMDA receptors (NMDAR1). When μ ORs are activated by β -endorphin or other agonists, postsynaptic NMDA-induced currents to glutamate are potentiated, which represents the main action of μ ORs in the NASshell. In the NAS and other brain regions, this form of potentiation appears to be a result of the ability of μ OR ligands to increase postsynaptic responses to NMDA receptor stimulation; Part B = in the NASshell, most spiny neuron dendrites that express μ ORs without colocalized NMDAR1 receive input from axons that: (a) express NMDAR1, and (b) DA afferents. DA D_1 and D_2 agonists injected into the NAS increase μ OR mRNA expression. Alternatively, μ OR agonists (morphine) administered in the NAS increase NAS DA release. This DA-opiate interaction in the NAS would thereby represent a DA-mediated potentiation of the effects of opiates on NAS dendritic μ ORs; Part C = activation of μ ORs localized on GABA-A interneurons in the VTA dose-dependently inhibits the GABA-induced inhibition of DA neurons – a net disinhibition of VTA DA neuron firing. This enhances VTA AMPA receptors, and hence DA neuron sensitivity to glutamate, particularly VTA DA neurons projecting to the NAS. See text for details. (Abbreviations as in Figures 5–8, except μ OR = mu-opiate receptor; GABA-A = gamma-amino-butyric acid type A receptor).

formation of affiliative memories: (1) enhanced somatodendritic DA release at the level of the VTA would facilitate the heterosynaptic plasticity that connects corticolimbic afferents carrying salient context to VTA DA neurons, as illustrated in Figure 9; and (2) enhanced VTA DA-NAS neurotransmission would facilitate corticolimbic afferents carrying salient context to NASshell spiny neuron dendrites (Carlezon & Wise 1996; Jaeger & van der Kooy 1996; Kuribara 1996; Leyton & Stewart 1992; Sora et al. 1997). Because β -endorphin neurons are activated by affiliative stimuli, *u*-opiate enhancement of VTA DA-NAS release would strengthen affiliative stimulus input to the NAS, in particular. *In all of these cases, opiate potentiation of glutamate and DA processes in the VTA and/or NASshell may facilitate specifically the incorporation of sociosexual and affiliative stimuli into a developing ensemble that represents the salient context of reward.*

6.3.3. Contribution of gonadal steroids, oxytocin, and vasopressin

6.3.3.1. Gonadal steroids. In many mammalian species, acute or prolonged internally- or sociosexually-induced gonadal steroid (estrogen, progesterone, testosterone) secretion temporally sets the occasion for most types of sociosexual interaction and the sensitivity to affiliative stimuli. It also can play a permissive role in the action of other sociosexually-related neuropeptides in a regionally specific manner, such as for oxytocin (OT), vasopressin (VP), and opiates. For example, depending on species but including humans, peripheral and central OT synthesis rate, release, and receptor proliferation, density and affinity; OT-induced sexual and maternal behaviors and reduction in autonomic arousal; mating-, grooming-, and stress-induced OT release; VP-induced aggression in male rodents; increased functioning and dendritic processes of OT and VP neurons; and opiate functioning can all be dependent, *at least in initial phases* of sociosexual interactions on gonadal steroid levels (Argiolas & Gessa 1991; Bale & Dorsa 1995a; 1995b; Bridges & Ronsheim 1987; Caldwell et al. 1989; 1994; Carter et al. 1995; 1997; de Kloet et al. 1986; Gorzalka & Lester 1987; Insel 1992; 1997; Insel et al. 1993; 1997; Jezova et al. 1996; Jirkowski et al. 1989; Johnson 1992; Keverne 1996; McCarthy 1995; McCarthy & Altemus 1997; Ostrowski 1998; Pedersen 1997; Petraglia et al. 1985; Sinchak & Micevych 2001; Wang & Devries 1993; Witt 1995; 1997; Young et al. 1998).

In addition to the effects of steroid hormones on the activity of neurons that express steroid receptors (Fleming et al. 1999; Hull et al. 1995), as illustrated in the left half of Figure 3, the internal hormonal milieu provided by gonadal steroids may play permissive and/or facilitatory roles in sensitizing sensory, perceptual, and attentional processes involved in detecting and transmitting external affiliative stimuli as a function of developmental period, circadian and circannual rhythms, reproductive cycle, and affiliative experience. For example, concerning permissive hormonal effects, male faces and odors evoke robust neurochemical release in the mediobasal hypothalamus of the ewe during, but not outside of, estrus (Fabre-Nys et al. 1997). Similarly, odors of lambs do not influence release of neurotransmitters or neuronal activity in adult sheep before giving birth, but they do after birth because of plastic changes in the olfactory bulb (Kendrick et al. 1992; 1997; Levy et al. 1992).

In a similar vein, virgin rats are repelled by pup odors but lactating females are not (Agren et al. 1997), and maternal recognition of rat offspring depends on both gonadal hormones and pup sensory cues (Calamandrei & Keverne 1994). And Ostrowski (1998) cites evidence that hormonal priming of the brain during pregnancy facilitates expression of human maternal behavior. But, in general, in primates and humans sexual and parental functions are much more loosely linked to gonadal steroid levels (Keverne 1996), indicating that neurobiological organization of sociosexual processes may vary in these species, and that the role of gonadal steroids may in these cases be more modulatory than permissive.

Perceptual preferences for certain affiliative cues may also rely in part on internal hormonal milieu. For example, human children show a preference for adult faces before puberty, whereas after puberty they prefer infantile faces that possess neotenus features (Fullard & Reiling 1976). After puberty, individuals prefer cues of potential sexual partners that may be viewed as exerting permissive or facilitatory effects on mate selection. Besides the permissive effects of physical cues related to apparent youth, health, and hence fertility (Buss 1989), human females are attracted to males, as measured by odor preference, who have major histocompatibility complex factors (e.g., human leukocyte antigen or HLA) different but complementary to their own, which may benefit their offspring's immune function by protecting against pathogens or may function as a mechanism to avoid inbreeding (Wedekind et al. 1995). But this effect is also dependent on hormonal variation related to the menstrual cycle. Women on oral contraceptives preferred the odors of males who had *similar* HLA to themselves (Wedekind et al. 1995). Likewise, recognition and bonding in mother–infant pairs is facilitated by HLA-influenced odor (Beauchamp & Yamazaki 1997). Furthermore, when perception of three categories of visual stimuli (nude men, babies, and stimuli related to body care) was measured in women across the menstrual cycle, it was found that, relative to other phases, during the preovulatory phase the ability to recognize sex stimuli was improved and stimuli were incorrectly labeled as sex stimuli (Krug et al. 1994). Thus, gonadal steroids may permit or facilitate the perception of sociosexual stimuli and the activation of sociosexually relevant neuropeptides, thereby enhancing their inclusion in contextual ensembles.

6.3.3.2. Oxytocin and vasopressin. OT and VP play a significant role in many sociosexual interactions, and they both are activated by projections arising from the MXA (de Olmos & Heimer 1999; Larsson & Ahlenius 1999; McDonald et al. 1999; Newman 1999). From a phylogenetic point of view, OT and VP, which are found only in mammals (Insel 1997), are nevertheless two of the most highly conserved hormones (Argiolas & Gessa 1991), and across mammalian phylogeny, the limbic structures that manifest OT and VP receptors are largely unchanged (Insel 1997; LeDoux 1987; 1998), indicating that human sociosexual processes are likely influenced by these neuropeptides. Most neuroanatomical and behavioral data on OT and VP, however, relate to rodents, and significant differences occur within rodent species in receptor distributions of OT and VP, and among practically every other mammalian species (Carter et al. 1995; 1997; Richard et al. 1991; Russell & Leng 1998). Indeed, there are important species differences between

rodents and anthropoid primates in the hormonal mechanisms mediating sexual behavior (Dixon 1998). Therefore, extension to human behavior requires empirical study.

In rodents and humans, a host of unconditioned and conditioned sociosexual stimuli elicit OT neuron activity, including vaginocervical stimulation at birth, genital and breast stimulation and copulation, olfactory stimuli, and suckling (Argiolas & Gessa 1991; Carter 1992; Carter et al. 1995; Forsling 1986; Insel 1992; 1997; Insel & Shapiro 1992; Keverne 1996; Keverne et al. 1983; McCarthy & Altemus 1997; Nissen et al. 1998; Richard et al. 1991; Witt 1995; 1997; Young et al. 1998). Nonsexual stimuli such as grooming, nongenital touch or light pressure, massage, hair stroking, pleasant vocalizations, warmth, and rat pup and lamb exposure can also induce OT release and OT dendritic arborization (Carter 1992; Carter et al. 1995; 1997; Insel 1992; Modney & Hatton 1991; Nelson & Panksepp 1996; Nissen et al. 1998; Uvnas-Moberg 1997). Such stimuli can also induce synaptic modifications in OT neurons of the supraoptic nucleus, such as increased dendritic synapses and an enhancement of electrical coupling between OT neurons (Fleming et al. 1999).

In turn, intracranially injected OT or unconditioned or conditioned stimulus-induced OT activity facilitates numerous sociosexual functions in male and female rodents, sheep, and humans, including milk ejection, uterine contractions, parturition, lordosis, copulation and ejaculation, rat maternal behaviors of retrieval and grouping of pups, licking of pups, nest building, and crouching, as well as affiliation patterns of mother–infant interaction, partner preference, offspring preference in sheep, and nonsexual social contact (Argiolas & Gessa 1991; Carter 1992; Carter et al. 1995; 1997; Englemann et al. 1998; Gorzalka & Lester 1987; Insel 1997; Insel & Hulihan 1995; Insel & Shapiro 1992; Insel et al. 1997; Kehoe & Blass 1989; Kendrick 2000; Kendrick et al. 1992; Keverne & Kendrick 1994; McCarthy & Altemus 1997; McCarthy et al. 1992; Meaney 2001; Nishimori et al. 1996; Nissen et al. 1998; Richard et al. 1991; Uvnas-Moberg 1997; Williams et al. 1994; Winslow & Insel 1991a; Winslow et al. 1993; Witt 1997; Witt & Insel 1991; Witt et al. 1990; 1992; Young et al. 1998). At least in female prairie voles, central administration of OT appears to be a critical component in the development of a partner preference even in the absence of mating (see below in this section on DA effects) (Insel & Hulihan 1995).

Less is known about VP, but in male prairie voles, mating is associated with an increase in VP mRNA in neurons that project to the lateral septum, and therefore, an increase in VP synthesis and release (Young et al. 1998). Also in male prairie voles, VP and VP antagonists promote or block, respectively, aggressive territorial mate protection, partner preference even without mating, paternal care, and perhaps social recognition memory (e.g., gustatory preference); and in human males VP levels peak during sexual arousal (Carter et al. 1995; 1997; Insel 1997; Popik & van Ree 1993; Wang et al. 1994; Winslow et al. 1993; Young et al. 1998). In juvenile rats, social recognition of conspecifics is VP-dependent in males in the lateral septum but not in the mPOA; in female rats, social recognition is VP-independent in the lateral septum, but is OT-dependent in the mPOA (Engelmann et al. 1996). Placement of the vasopressin V1a receptor gene from the affiliative prairie vole into nonaffiliative mice resulted in enhanced affiliative behaviors in the mice, and experimentally increasing the V1a

receptor gene using viral vector gene transfer in the ventral pallidum enhanced affiliation and pair bonding (Young et al. 1999). Although OT (female) and VP (male) functions are gender-dependent in some rodents, the fact that both neuropeptides are found in both sexes in rodents and humans indicates that their role in each gender requires further specification (Argiolas & Gessa 1991; Strand 1999). In prairie voles, VP receptors are very dense in the ventral pallidum and OT receptors are very dense in the NAS in both males and females, indicating that this receptor distribution is not related to “male” or “female” behaviors specifically.

Four points concerning the possible functional role of OT and VP can be suggested. First, neither OT nor VP appears to mediate reward, although OT can facilitate it (Sarnyai & Kovacs 1993). For example, self-administration of heroin is facilitated by an OT analogue, whereas a VP analogue inhibited it (van Ree & De Wied 1977). Second, in view of their diverse physiological targets and sociosexual functions, the role of these neuropeptides may be more generally one of facilitative modulation than mediation (Carter et al. 1997). For example, genetically engineered knockout mice that have a deficiency of OT everywhere, including in the main brain sites of central OT synthesis [paraventricular nucleus (PVN) and supraoptic nucleus (SON) of the hypothalamus], are viable and fertile (Nishimori et al. 1996; Young et al. 1999). Both males and females of such mice have no fertility, reproductive, or parenting behavioral or functional deficits except a female inability to nurse (eject milk). These effects were not a result of altered receptor distribution or abundance. Also, reductions of up to 60% of the normal birth-induced OT increase did not affect maternal behavior of sheep, other than a reduced peak in low-pitched bleats and lamb sniffing (da Costa et al. 1999). On the other hand, OT may be more necessary to reproductive and maternal behavior in rats. Significantly, rats are maternal only after parturition (Brown et al. 2000), whereas mice and most primates exhibit maternal behavior independent of parturition. Therefore, species with more general activation of maternal behavior may be less dependent on the facilitatory effects of OT and permissive effects of gonadal steroids on maternal behavior, but more dependent on neurobiological networks and neurotransmitters that are more generally active and responsive to affiliative stimuli (Insel & Winslow 1998).

Third, the importance of OT and VP may be more predominant in the *initiation* (or appetitive phase) than in the *maintenance* of sociosexual functions (Carter et al. 1997; Insel & Shapiro 1992; Keverne 1996; Nelson & Panksepp 1998). For instance, OT antagonists or PVN lesions that eliminate OT and VP neurons (and possibly receptors) disrupt initiation of nurturant, maternal, and reproductive behaviors, but have no effect once maternal behavior is established (Ostrowski 1998). Also, both procedures interfere with the formation of partner preferences, which develop in the initial mating bouts in prairie voles (Carter et al. 1995; Insel & Shapiro 1992; Williams et al. 1994). Similarly, OT knockout mice are deficient in forming social recognition memories that would be necessary in acquiring mate preferences (Ferguson et al. 2000; Nishimori et al. 1996; Winslow & Insel 2002). Also, sexual interaction increases OT plasma levels in sexually naive male rats, but not in sexually experienced rats, suggesting that OT is activated mainly under novel circumstances involving acquisition phases of learning and memory compared to circumstances

when learning has already occurred (Hillegaart et al. 1998). Moreover, whereas *acute* sexual activity in rodents promotes OT and VP release, mating behaviors, and social memories, the decreased copulatory frequency, increased social (nonsexual) contact, prolonged reduction in sympathetic autonomic and neuroendocrine activation, increased vagal tone, and calm sedation that is associated with *repeated* sexual activity over several days is blocked by opiate, but not OT, antagonists (Carter et al. 1997).

Fourth, *peripheral* versus *central* OT and VP systems in rodents and humans can differ in their functional effects, receptor regulation and distribution, and stimulus-elicitors (Carter et al. 1995; 1997; Insel 1992; 1997; Keverne 1996; Strand 1999; Uvnas-Moberg 1997). They are therefore potentially dissociable. The peripheral system involves OT and VP *magnocellular* neurons in the PVN and SON that activate OT and VP secretion from the neurohypophysis. In turn, OT and VP traverse the blood stream locally to the anterior pituitary, as well as more broadly to effect many peripheral functions, such as uterine contractions and milk ejection. In contrast, the central system involves OT and VP *parvocellular* neurons in the PVN that project to many corticolimbic regions, such as the amygdala, BNST, NAS, and prelimbic cortex (Carter 1992; Carter et al. 1995; 1997; Hulting et al. 1996; Insel 1992; 1997; Insel et al. 1997; Insel & Shapiro 1992; Ivell & Russell 1996; McCarthy & Altemus 1997; Richard et al. 1991; Strand 1999; Uvnas-Moberg et al. 1990; Witt 1995; 1997). Thus, whereas the peripheral system seems well positioned to facilitate basic bodily processes related to sociosexual functions, the broad central corticolimbic distribution may correspond to an increased capacity to guide sociosexual interactions by more general motivational processes and by social memories. Therefore, central OT and VP may play a critical role in facilitating limbic-based memory and motivational processes that either: (a) enhance recognition of mate sensory stimuli, and/or (b) associate mate and offspring stimuli with reward (Carter et al. 1997; Insel 1992; Insel & Shapiro 1992; Winslow & Insel 2002).

In support of point (a), the modulatory role of OT on the maternal behavior of rats, which is expressed only after parturition, is strongly exerted at the level of incoming sensory stimuli. For example, OT antagonist administration in the olfactory bulbs reduces maternal behavior of rats (Yu et al. 1997, and prepartum destruction of noradrenergic input to the rat olfactory bulb, which interacts with OT receptors in the bulb, also impairs maternal behavior (Insel et al. 1993). Vaginal stimulation enhances oxytocin receptor (OTR) sensitivity in the olfactory bulb, but this stimulation only potentiates lamb olfactory memory formation or consolidation when it is applied in the presence of the offspring, indicating that OT is potentiating olfactory stimulus processing (Keverne et al. 1997; Popik & van Ree 1991; 1993; Popik et al. 1992). Such sensory potentiation may be important in humans, wherein sociosexual behavior is less tightly linked to gonadal steroids and neuropeptides, but is significantly influenced by affiliative stimuli (Keverne 1996).

In support of point (b), OT activation facilitates association of the odor of a mate with copulation in male prairie voles, thereby promoting partner preference (Young et al. 1998), and similar effects have been found for OT and VP in rats (Dantzer et al. 1987; 1988; Popik et al. 1992; Renelli et al. 1995). OT also appears to facilitate olfactory-based memory acquisition that maternal sheep form of their off-

spring in the 2 to 4 hour post-parturition bonding window (Kendrick et al. 1992). Also, OT knockout mice are deficient in forming social recognition memories (Ferguson et al. 2000; Nishimori et al. 1996; Winslow & Insel 2002), an effect that may be a result of the lack of OT, and hence, of OT receptor activation, in the medial nucleus of the amygdala and in the BNST, where olfactory and contextual cues, respectively, are associated with reinforcement. For example, OT knockout mice fail to recognize familiar conspecifics after repeated social encounters; however, central OT administration into the amygdala restores social recognition (Winslow & Insel 2002).

There are several ways in which OT may modulate affiliative memories in addition to enhancing sensory processing. First, OT improves the establishment of long-lasting long-term potentiation in the acquisition of hippocampal-dependent spatial learning and memory (Tomizawa et al. 2003). Interestingly, this effect is particularly strong during motherhood in mice, suggesting an interaction with gonadal steroid status.

Second, in the human brain OTRs are densely expressed by the basal forebrain acetylcholine (ACh) neurons in the nucleus basalis of Meynert and the diagonal band of Broca (Insel 1997; McCarthy & Altemus 1997). The nucleus basalis sends projections to the amygdala, hippocampus, thalamus, olfactory bulbs, and brainstem, whereas the diagonal band densely innervates the hippocampus (Kandel et al. 1991; Nauta & Feirtag 1986). Moreover, both neuron regions send diffuse projections that release ACh in the neocortex (Nauta & Feirtag 1986). Taken together, these ACh afferents are known to modulate memory systems in the amygdala, hippocampus, and neocortex, indicating that OT may modulate memory formation or consolidation through its influence on ACh function (McGaugh 2000).

Third, OT neurons in the PVN projecting to β -endorphin neurons in the arcuate nucleus can increase opiate release by 300% (Csiffary et al. 1992). Thus, OT may facilitate the rewarding effects of opiates, which, in turn, would promote reward-mediated associations. In contrast, many peripheral OT functions can be inhibited presynaptically by direct β -endorphin projections to magnocellular PVN OT neurons, wherein OT synthesis and release from OT terminals is inhibited (Cassidy 1999). Moreover, in rats, opiates inhibit OT release peripherally, and opiate antagonists result in enhancement of OT neurons centrally (Keverne & Kendrick 1991). Similarly, during labor in female humans, exogenous opiates inhibit OT secretion (Lindow et al. 1993). All of these results indicate that the effects of opiates in bringing affiliative interactions to a gratifying *conclusion* may involve suppressing the OT-facilitated *initiation* of affiliative behavior (Brown et al. 2000).

Fourth, OT interacts with DA in the NAS and VTA, thereby potentially modulating DA facilitation of the acquisition of affiliative contextual ensembles. DA D3 receptors also mediate increases in the release of OT (Uvnas-Moberg et al. 1995). OT interaction with NAS DA may increase sensory processing or memory processes (Drago et al. 1986; Kovacs et al. 1990; Sarnyai et al. 1990). Because both OT and DA are involved in facilitating partner preference in female prairie voles, their interaction in the NAS and VTA may play an important role in such memory formation (Gingrich et al. 2000; Insel & Hulihan 1995; Wang, H. et al. 1999; Williams et al. 1994). The affiliative male and female prairie voles have a dense concentration of OT receptors in the NAS,

whereas this is not the case in the nonaffiliative montane vole (Insel & Shapiro 1992). Moreover, blockade of NAS OT receptors abolishes partner preference formation in general (Gingrich et al. 2000), as well as the facilitatory effects on partner preference of a DA agonist that was injected intracerebroventricularly (Gingrich et al. 2000). In addition, OT neurons in the rostral PVN and dorsolateral POA send afferents to the VTA, which facilitate maternal behavior in the postpartum (Insel 1997). And OT injected intracerebroventricularly induces a robust and enduring increase in the firing rate of VTA DA neurons (Yu et al. 1997). When taken with the fact that the affiliative prairie vole also has a much more dense presence of VP receptors in the ventral pallidum than the nonaffiliative montane vole, and experimentally increasing VPIAR in the ventral pallidum results in enhanced affiliation and pair bonding (Young et al. 1999), perhaps OTRs in the NAS and vasopressin receptors (VPRs) in the DA receptor-rich ventral pallidum play a critical role in enhancing the incorporation of affiliative stimuli in the salient context predictive of affiliative reward.

6.4. Integrative summary

Our discussion indicates that numerous neurobiological variables contribute to affiliative behavior patterns. Rather than explicating all of the many sociosexual functions subserved by these variables, we organized their contribution around the processes of approach and consummatory phases of reward and memory formation, because we believe that these are most critical to the development and maintenance of affiliative bonds. Thus, we suggested that DA in interaction with glutamate within an MOC network encodes the incentive salience of contextual stimuli predictive of reward during the approach phase and, in collaboration with μ -opiate-mediated consummatory reward, encodes the incentive salience of proximal stimuli directly linked to the affiliative object. Whereas it appears that μ -opiates provide an independent contribution to the experience of consummatory reward, their interaction with DA processes in the VTA and NAS are critical for the formation of social memories. The end result of this sequence of processes is an incentive-encoded affiliative memory network that continues to motivate approach toward and interaction with the affiliative object.

Of course, affiliative memory formation and consolidation involve other processes and brain regions. Therefore, we focused on the specialized processes that may ensure that affiliative stimuli are weighted as significant elements in the contextual ensembles representing affiliative memory networks. These specialized processes include: (a) the binding of affiliative stimuli in the MXA and subsequent transmission to the NAS; (b) the construction of a contextual ensemble via affiliative stimulus-induced opiate potentiation of DA processes in the VTA and NAS; and (c) the influence of permissive and/or facilitatory factors, such as gonadal steroids, OT, and VP, on (1) sensory, perceptual, and attentional processing of affiliative stimuli and (2) formation of social memories.

7. Neurodevelopmental sources of individual differences in trait affiliation

A basic challenge in deriving a neurobiological model of a personality trait is to identify the sources of individual dif-

ferences that occur within the functioning of the network of neural structures and variables associated with the trait. Individual variation in all of the neurobiological variables and processes, discussed in section 6, is likely to contribute to variation in the level of trait affiliation. For us, however, the capacity to experience affiliative reward has a disproportionately high weight in determining the level of trait affiliation, because it influences both: (a) the basic reward sensitivity to affiliative stimuli, and hence (b) variation in the development of associative memory networks that support the maintenance of affiliative preferences and bonds. Therefore, we focus on individual differences in central μ -opiate functioning and on its neurobiological modulators (i.e., DA, OT, VP) as mediators of variation in affiliative reward and trait affiliation. Because individual differences emerge through dynamic developmental processes (Collins & Depue 1992), our discussion of the animal work on individual differences is organized around three neuro-developmental sources of input to the brain: genetic, experience-expectant, and experience-dependent processes (Greenough & Black 1992).

7.1. Genetic variation in μ -opiate properties

Tellegen's measure of trait affiliation, Social Closeness, is subject to significant genetic variation (Tellegen et al. 1988). If u -opiates are a major source of variation in this trait, individual differences in opiate functioning would also be expected to exhibit genetic variation. Most animal and human genetic research has focused on u OR expressive properties, wherein differences appear to result in large part from variation at the u OR gene locus rather than from u OR affinities per se (Uhl et al. 1999). Individual differences in humans and rodents have been demonstrated in levels of u OR expression and binding that are associated with a preference for u -agonists, such as morphine (Belknap et al. 1995; Berrettini et al. 1994a; 1994b; Berrettini et al. 1997; Sora et al. 1997; Uhl et al. 1999; Zubieta et al. 2001). In humans, individual differences in CNS u OR densities show a range of up to 75% between the lower and upper thirds of the distribution (Frost et al. 1988; 1989; Pfeiffer et al. 1982; Uhl et al. 1999), differences that appear to be related to variation in the rewarding effects of alcohol in humans and rodents (Berrettini et al. 1997; De Waele et al. 1994; 1995; Gianoulakis 1993; Gianoulakis & De Waele 1994; Gianoulakis et al. 1992; 1996; McCall et al. 2000a; 2000b; Olson et al. 1997). The greatest proportion of variation in u OR density in humans appears to be governed by a *single* genetic locus that contains the human u OR gene (Berrettini et al. 1997; Wendel & Hoehe 1998). Moreover, broad individual variability in normal human u OR binding potential not only has been demonstrated under placebo conditions, but also in the change in binding to a standardized stressful stimulus, indicating that individual differences in the u OR system may be observed under resting conditions as well as in the dynamic response to stimuli (Zubieta et al. 2001).

Differences of this magnitude in the *expressive* properties of the u OR gene could contribute substantially to individual variation in u OR-induced *behavioral* expression via an effect on B -endorphin functional potency. For example, one source of this individual variation is different single nucleotide polymorphisms (SNPs) in the u OR gene, OPRM1 (Berrettini et al. 1997; Bond et al. 1998; Gelernter et al.

1999). The most prevalent of these is A118G, which is characterized by a substitution of the amino acid Asn by Asp at codon 40, with an allelic frequency of 10% in a mixed sample of former heroin abusers and normal controls (Bond et al. 1998). Although this SNP did not bind all opiate peptides more strongly than other SNPs or the normal nucleotide sequence, it did bind *B*-endorphin three times more tightly than the most common allelic form of the receptor (Bond et al. 1998). Furthermore, *B*-endorphin is three times more effective in agonist-induced activation of G-protein-coupled potassium channels at the A118G variant receptor compared to the most common allelic form (Bond et al. 1998).

Genetic variation in *uOR* properties is related to response to rewarding drugs, such as morphine, alcohol, and cocaine, and to opiate self-administration behavior in animals (Berrettini et al. 1997). For instance, the recombinant inbred mouse strain B6, which has 33% fewer *uORs* than six other inbred strains, showed relative insensitivity to opiate agonists. As a means of compensating for the reduced *uORs*, the B6 strain self-administered four times the amount of opiate agonists as the other strains, and showed an increased resistance to extinction after removal of active drug (Elmer et al. 1995). Furthermore, the B6 strain experiences far greater sensitivity, in terms of locomotor activation, learning/memory, and muscular rigidity, than the D2 strain to most opioid-activating drugs, such as ethanol, morphine, and cocaine (Berrettini 1994b; Mogil et al. 1999a; 1999b; Wendel & Hoehe 1998). In addition, when transgenic insertion was used to increase *uOR* density specifically in mesolimbic areas thought to mediate substance abuse via VTA DA neurons, transgenic mice showed increased self-administration of morphine compared to wild-type mice, even when the amount of behavior required to maintain drug intake increased tenfold (Elmer et al. 1995). Thus, the efficacy of morphine as a reinforcer was substantially enhanced in transgenic mice. Conversely, *uOR* knockout mice do not develop conditioned place preference and physical dependence on morphine, whereas morphine induces both of these behaviors in wild-type mice (Matthes et al. 1996).

Taken together, these studies suggest that genetic variation in *uOR* properties in humans and rodents is: (a) substantial, (b) an essential element in the variation in the rewarding value of opiates, and (c) critical in accounting for variation in the Pavlovian learning that underlies the association between contextual cues and reward, as occurs in partner and place preferences (Elmer et al. 1995; Matthes et al. 1996).

7.2. Genetic variation in modulators of opiate functioning: DA, OT, VP

Opiate effects on affiliation are modulated by the facilitatory effects of OT and perhaps VP, facilitatory or permissive effects of gonadal steroids, and are directly dependent on the interaction with DA in the VTA and NAc shell. Such interactive effects of OT, VP, and DA with μ -opiate functioning could influence the expressive qualities of incentive-driven approach to affiliative stimuli, the rewarding qualities of affiliative interactions, and the extent to which neutral cues are associated with affiliative objects and contexts (i.e., acquisition of social memories). As discussed in section 6.3.2, there are direct modulatory effects in the in-

teraction of DA and *u*-opiates in the VTA and NAc shell, such that genetically influenced individual differences in either DA or *u*-opiates could modulate the functioning of the other variable. As we and others have reviewed recently, genetic variation in VTA DA and/or NAc DA functioning has powerful effects on a wide range of incentive-motivated behaviors, including affiliation, acquisition of self-administration of DA agonists, and conditioned reinforcement (Depue & Collins 1999; Gelernter et al. 1998; Le Moal & Simon 1991; Piazza & Le Moal 1996; Puglisi-Allegra & Cabib 1997). Such differences could modify DA's influence in the initial, appetitive phases of establishing an affiliative bond via variation in incentive reward encoding and contextual conditioning. Alternatively, genetic variation that influences expression or function of *uORs* contributes to variation in the neuroadaptive properties of the mesolimbic DA system that can affect affiliative behavior (Smolka et al. 1999).

Individual differences in the facilitatory effects of OT on opiate functioning could influence the frequency and quality of expression of opiate-modulated behaviors, and could modulate formation of affiliative memories (e.g., Ferguson et al. 2000). A polymorphism at the human OTR gene has been identified on chromosome 3 (Michelini et al. 1995). The human DNA encodes a 388 amino acid polypeptide with several possible sites for post-translational modifications (Kimura et al. 1992). In the 3' nontranslated region of the human OTR cDNA, there is a stretch of 15 CA dinucleotide repeats (bases 2246–2277) that are often polymorphic (Michelini et al. 1995). The polymorphism contains two alleles, which occur with frequencies of 0.77 and 0.23 in a sample of Caucasian CEPH parents. These mutations in the sequence of the OTR gene could alter the biological effects of OT (Michelini et al. 1995), although it is not yet clear how these polymorphisms relate to behaviors associated with OT functioning in humans. Clearer, is that extreme sociosexual differences between some species appear to be related to variation in OT and VP receptor brain distribution and density rather than in presynaptic features, variation that is likely to be of genetic origin (Insel 1997; Strand 1999; Young et al. 1998). For example, prairie voles show extensive maternal care and extended sexual behavior that promotes social preferences for familiar partners, although intimate social contact is the primary influence on the development of emotional bonds (Mason & Mendoza 1998). In contrast, montane voles live in isolated burrows, do not show selective pair-bonds, show little parental care, and spend little time with other voles (Insel & Shapiro 1992). There is a differential distribution of OT and VP receptors in prairie and montane voles, who are monogamous and polygamous, respectively. Relative to montane voles, prairie voles show much denser OTR and VPR distribution in reward areas, such as the prelimbic cortex, the NAS, and ventral pallidum, which could directly influence the development of partner preference (Young et al. 1998; 1999). Also, Young et al. (1999) demonstrated that placement of the VP gene from the affiliative prairie vole into nonaffiliative mice resulted in enhanced affiliative behaviors in the mice, and that experimentally increasing the vasopressin V1a receptor gene using viral vector gene transfer in the ventral pallidum enhanced affiliation and pair bonding. Importantly, there are significant *within-species* differences in prairie voles in: (a) the vasopressin V1a receptor gene, which appears to manifest great potential for polymor-

phism (Hammock & Young 2002; Young et al. 1999), and (b) NAS density of OTR (Young 1999; Young et al. 1999), raising the possibility that intraspecies variation in affiliative behavior may also be subject to genetic influence.

7.3. Experiential contribution to individual differences in affiliative behavior

As measured by Tellegen's Social Closeness scale, affiliation not only shows significant genetic influence, but also substantial modification via experiences that occur both within and outside the family (Tellegen et al. 1988). Experiential sources of individual differences derive from two main sources: *experience-expectant* and *experience-dependent* processes (Collins & Depue 1992; Greenough & Black 1992). *Experience-expectant* processes involve widespread cortical synapse overproduction during sensitive periods in brain development when critical stimulation relevant to a specific neural system is likely to occur (Greenough & Black 1992; Rakic et al. 1986). Following overproduction, excess cortical synapses are "pruned back" in response to relevant environmental stimulation. The basic implication of experience-expectant processes for the development of individual differences is that the degree of stimulation-rich environment will be encoded in the number of functional synaptic connections within neural pathways. Moreover, during expectant periods, individual differences in both genotypic processes (e.g., *u*-opiate neuron number or *u*OR density) and environmental experience (e.g., quantity and/or quality of infant-maternal interactions) would be expected to collaborate. The outcomes of such periods therefore might establish different trajectories in the functional development of the *u*-opiate system across individuals, and thus partially specify eventual trait levels of affiliation.

It is unknown whether experience-expectant processes are a significant source of individual differences in OT, VP, or *u*-opiate functioning, but sensitive periods in the postnatal development of the OT and opiate systems do exist. In both rodents and primates, shortly after birth there is overproduction and later pruning of OTR and VPR (around weaning) in limbic areas of the brain, notably in the cingulate cortex, a region that is important in evaluation of emotional significance of sensory stimuli (Carter 1998; Insel 1997; Insel & Winslow 1998). There is also higher OT binding in the cingulate cortex, dorsal subiculum, NAS, and anterior nucleus of the olfactory bulb in the preweaning compared to adult stage in rats, regions that are associated with social memory, reward processes, and infant behaviors directed towards the mother (Shapiro & Insel 1989). Upon pruning of these innervations at weaning, there is a substantial change in social behavior in the infant (Nelson & Panksepp 1996; Nissen et al. 1996). Thus, this overproduction and pruning back of OT innervations appears to be coincident with a sensitive period of nursing and, by association, of affiliative bonding between mother and infant.

OTR expression in female rodents and primates also undergoes changes across the lifespan that are estrogen dependent: expression is high in infancy (unrelated to estrogen), declines in the early years of life, and then increases at puberty, mating, and during parturition and childbirth (Insel & Winslow 1998). At parturition, OTR increase in number in the mPOA, VMN, and BNST of female rats (Nelson & Panksepp 1998; Witt 1995). In human infancy, OTR primarily are distributed in the cingulate cortex,

globus pallidus, and the midline nucleus of the thalamus, whereas in the adult, OTR are distributed in the BNST and VMN regions that contain no OT receptors before maturity. These brain areas are important for sexual and nurturant behavior and for associative processes between context and reward that support the acquisition and maintenance of pair bonding (Insel 1992).

*u*OR expression and density also undergo developmental change, increasing rapidly during development in the rat brain (Pintar & Scott 1993). *u*OR densities in the globus pallidus and VTA are high in the immediate postnatal period but then decline to adult levels during the first month, coinciding with the early period when the infant is with the mother most of the time (Pintar & Scott 1993). Interestingly, more precocial species, such as lambs, show *u*OR expression at birth that is more similar to adult expression than that of altricial species, such as rats or mice (Pintar & Scott 1993). Thus, changes in regional expression of OTR and mRNA for OTR, *u*OR, and their projections, from birth through adolescence, mating, parturition, and parenting, suggest that plasticity in these systems allows for rewiring of neural circuits that enable the encoding of environmental experience during critical events of the lifespan (Ostrowski 1998). In this way, species-typical experiences can affect affiliative behavior through the influence of developmental processes on peptide functioning (Ostrowski 1998).

Experience-dependent processes encode experience unique to the individual through interactions of neurotransmitters and neuropeptides that modulate dendritic outgrowth, synaptogenesis, synaptic regression and hence synaptic connectivity, or the intrinsic excitability of neurons within the distributed structures of a particular neural system or network (Colman et al. 1997; Magee & Johnston 1997; Mattson 1988; Zhang & Linden 2003). As discussed in various sections above, OT, VP, *u*-opiate, and DA are capable of undergoing and also of inducing neural plasticity as a function of environmental experience. Repeated exposure can result in sensitization or an *augmented response* to cues, thereby increasing the probability of their being incorporated into contextual ensembles that predict affiliative reward. This is a critical point, because whereas social recognition can occur rapidly and may not involve close contact, the development of social preferences (implying formation of affiliative memories based on reward) primarily is dependent on *repeated intimate social contact* (Insel & Winslow 1998; Mason & Mendoza 1998). For example, mating in female prairie voles leads to a partner preference, but the formation of the preference is time- and experience-dependent, requiring at least 14 hours of male exposure with 10–20 bouts of copulation during this interval (Insel & Hulihan 1995; Wang, Z. et al. 1999). Also, male rats show enhanced response to estrus female rat bedding with repeated noncopulatory olfactory exposure, but not to male or ovariectomized female bedding (Mitchell & Gratton 1991). Additionally, rat pups acquire preference for a maternally associated odor with experience (Nelson & Panksepp 1996), and they are more likely to approach an odor that was paired with maternal reunion on the previous day (Panksepp et al. 1997).

Nurturant behavior can also be enhanced as a result of experience, because it can be induced in nonpregnant female rats and male rats by repeated exposure to pups, which has been interpreted as sensitization to the pups' sen-

sory cues (Cruz & Del Cerro 1998; Rosenblatt 1994). Moreover, rat dams find their pups more rewarding after experience (Fleming et al. 1999), and more frequently press a bar that provides access to pups compared to inexperienced female rats (Lee et al. 1999). After only two exposures, these mothers also favor visual environments that were paired with their pups (Fleming et al. 1994). Deprivation of experience can have the opposite effect. Whereas only 2 hours of interaction between mother and rat pups on the first day after birth is sufficient to permit maternal behaviors toward foster pups 10 days later (Orpen & Fleming 1987), maternal behaviors are diminished over the first week after birth if mothers and offspring are separated (Fleming et al. 1999; Orpen & Fleming 1987). Ewes also appear to develop a transient olfactory memory of their lambs within 1–2 hours postpartum if they have been exposed to olfactory and vaginocervical stimulation, but this is blocked if they are separated from their lambs for 3 hours thereafter. However, with exposure to lambs for 12–24 hours postpartum, the ewe will remember her lamb even after a 6-hour separation, in tandem with extensive reorganization of connections in the olfactory bulb (Keverne et al. 1997).

Human maternal experience itself can prime or sensitize the neurochemical mechanisms that enable mothers to recognize their offspring (Fleming et al. 1999). New mothers show enhanced sensitivity to sensory cues emitted by infants as a result of experience, in that, for example, they can correctly identify the cry of their infant above the din of multiple infant cries after only a brief exposure (Cismaresco & Montagner 1990). Because olfactory stimuli are primary triggers of sexual and maternal behavior in many species, the tight linkage between olfactory cue consolidation and mating behavior that has developed throughout evolution might be present even in humans who have become less dependent on olfaction as a primary sensory modality for recognition of affiliative objects (Englemann et al. 1996). The infant's own interaction between perceptual preferences and behavior may affect memory formation, in that infants prefer the smell of lactating women's breasts compared to the breasts of nonlactating women (Makin & Porter 1989). Furthermore, human infants prefer the smell of their mother's breasts, and their mother's odor can attenuate crying in distressed infants, both findings suggesting that infants form recognition memories based on their mother's odor (Porter 1999; Porter et al. 1991). The sooner human mothers breastfeed after birth and the closer they keep their faces to their infants when holding them, thereby allowing for increased odor exchange, the more appealing they find their infants' body odors and the more accurately they recognize their infants' odors (Cortner & Fleming 1995; Fleming et al. 1999). Moreover, women are able to recognize the smell of their infants within hours of giving birth (Keverne et al. 1997), and can identify their infant by the odor of their shirt or by smelling the heads of several infants while blindfolded after a short period of exposure (Kaitz et al. 1987; Russell & Leng 1998). Significantly, the mothers who accurately identified their infants from olfactory cues typically had been exposed to their infants earlier and for a longer period of time, had engaged in closer interactions with their infants, and felt more intense warmth and nurturance than women who were not accurate in their identification (Cortner & Fleming 1995; Cruz & Del Cerro 1998). In addition to olfactory exposure, vaginocervical stimula-

tion at birth in human mothers may be an important *initial* experiential variable in forming memories and in bonding with infants. Mothers who gave birth via vaginal delivery versus Caesarean section showed more effective nursing and affiliative behaviors toward their infants in the first few days after birth (Uvnas-Moberg 1997). Of course, human mothers have other, more recently evolved modalities for recognizing their infants, but this might represent an important experiential contributor to bonding with one's offspring.

The significance of these various findings is that maternal behavior, at least in rodents, is a major source of not only offspring neural, endocrine, and genetic development that affects offspring emotional reactivity, but also of maternal behavior of offspring as adults (Meaney 2001). Thus, maternal behavior serves as a major source of intergenerational transmission of behavioral profiles in offspring across the life span. In humans, parental factors also can mediate the effects of environmental adversity on development and offspring behavior, including the effects of poverty on child development (Conger et al. 1994; Eisenberg & Earls 1975; McLloyd 1998), and early stress has deleterious effects on adult attachment behavior (Henry & Wang 1998). Furthermore, other temperament factors that affect the behavior of the mother, such as neuroticism, attachment style, separation anxiety, and rejection sensitivity will likely modify affiliative bonding with offspring.

Thus, the capacity for and regulation of neuroplasticity by these neural systems may be one avenue for *collaboration* among genotypic, experience-expectant, and experience-dependent processes (Collins & Depue 1992; Depue & Collins 1999). By way of example, in the case of a highly nurturing, affectionate mother–infant interaction during nursing, which may in part be a result of genetic influence on the μ -opiate system of the mother as well as the infant, the likely (but not inevitable) outcome of this sensitive, expectant period would be a strong functional capacity in the *u*-opiate system of the infant to respond to unconditioned and conditioned affiliative stimuli. Subsequent experience-dependent processes would likely maintain this capacity, because an enduring predisposition to engage unconditioned and conditioned affiliative stimuli established during experience-expectant development would entail frequent activation of synaptic connections in the terminal fields of *B*-endorphin projections. Thus, early experiential processes may lay the foundation for *trends* in affiliative approach and bonding behavior across the life span by moderating the strength of subsequent experience-dependent processes (such as dendritic arborization or neuropeptide release) involving the functional capacities of *B*-endorphin, OT, and VP projection systems.

8. Modeling behavioral effects of individual differences in *u*-opiate functioning on the acquisition and maintenance of affiliative bonds

Our discussion in section 7, concerning the sources of individual differences in the functioning of variables potentially associated with affiliative behavior, naturally raises the question of how such individual differences contribute or translate to behavioral variation that comprises the phenotype of trait affiliation. In short, how can such psychobio-

logical individual differences be modeled to better understand variation in affiliative behavior.

As we have argued in section 7.1, research suggests that individual differences in *u*-opiate functioning are associated with variation in the magnitude of gratification experienced from naturally occurring rewards, presumably also from affiliation-elicited reward. We now more specifically, albeit speculatively, model the influence of individual differences in *u*-opiate-mediated affiliative reward on affiliative behavior (sect. 8.1), and discuss the implications of the model for a trait of human affiliation, particularly in terms of acquisition and maintenance of affiliative bonds (sect. 8.2). In so doing, it is worth noting that a major source of individual differences that broadly overlays other sources of individual variation is that females appear to have a greater disposition to express attachment-caregiving behavior than males (Taylor et al. 2000). Finally, in section 8.3, we present our preliminary human evidence suggesting that variation in opiate functioning is associated with the trait of affiliation.

8.1. A psychobiological threshold model of affiliative reward

Models of behavioral processes often employ a minimum threshold that represents a central nervous system weighting of the external and internal factors that contribute to initiation of the processes (Depue & Collins 1999; Stricker & Zigmond 1986; White 1986). In the case of affiliative reward, the threshold would be weighted most strongly by the joint function of two main variables: (i) magnitude of affiliative stimulation, which ultimately is mainly a function of the magnitude of reward induced by an unconditioned or conditioned affiliative incentive stimulus, and (ii) level of *u*-opiate postsynaptic receptor activation (e.g., by endoge-

nous *B*-endorphin) (Belknap et al. 1995; Berrettini et al. 1994a; 1994b; Frost et al. 1988; 1989; Gianoulakis 1993; Gianoulakis et al. 1996; Olson et al. 1997; Pfeiffer et al. 1982; Sora et al. 1997; Uhl et al. 1999). The relation between these two variables is represented in Figure 12 as a trade-off function (Grill & Coons 1976; White 1986), where pairs of values (of affiliative stimulus magnitude and *u*-opiate activation) specify a diagonal representing the minimum threshold value for activation of affiliative reward. Findings we reviewed in section 6.1.2 show that agonist-induced *state* changes in *uOR* activation influence the threshold of reward, as indicated by modifications in the efficacy of inherently rewarding stimuli, an effect that may be especially mediated by *uORs* located in the VTA and NAS (Duvauchelle et al. 1996; Herz 1998; Koob & Le Moal 1997; Schlaepfer et al. 1998; Shippenberg & Elmer 1998). Because the two input variables are interactive, independent variation in either one not only modifies the probability of affiliative reward, but it also simultaneously modifies the value of the other variable that is required to reach a minimum threshold of affiliative reward. Finally, individual variation in variables that significantly interact with *u*-opiate functioning would serve as a source of modulation of the threshold of affiliative reward, and in Figure 12 variation in the modulatory effects of DA, OT, VP, and gonadal steroids is so represented. For example, increased functional activity of these modulators would increase *u*-opiate activity and thereby decrease the threshold for affiliative reward.

8.2. Implications for conceptualizing a trait of affiliation

A threshold model allows behavioral predictions that have implications for conceptualizing trait affiliation. A *trait* di-

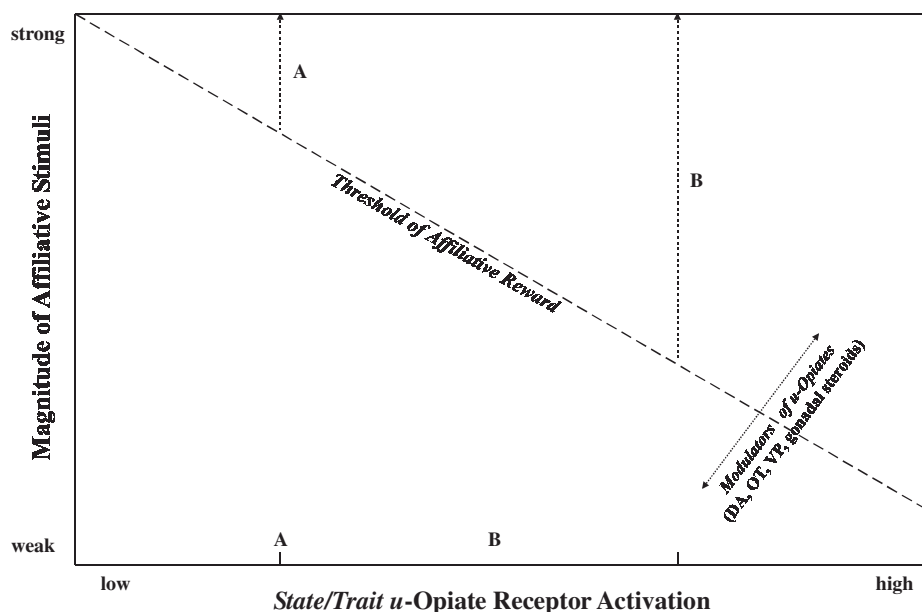

Figure 12. A minimum threshold for affiliative reward is illustrated as a trade-off function between affiliative stimulus magnitude (left vertical axis) and central μ -opiate postsynaptic receptor activation (horizontal axis). Range of effective (reward-facilitating) affiliative stimuli is illustrated on the right vertical axis as a function of level of μ -opiate activation. Two hypothetical individuals with low and high *trait* μ -opiate postsynaptic receptor activation (demarcated on the horizontal axis as A and B, respectively) are shown to have narrow (A) and broad (B) ranges of effective affiliative stimuli, respectively. Threshold effects resulting from DA, OT, VP, and gonadal steroid modulation are illustrated, as well. See text for details. (Abbreviations: DA = dopamine; OT = oxytocin; VP = vasopressin).

mension of μ -opiate postsynaptic receptor activation is represented on the horizontal axis of Figure 12, where two individuals with divergent trait levels are demarcated: *A* (low trait level) and *B* (high trait level). These two divergent individuals may be used to illustrate the effects of trait differences in μ -opiate receptor activation on both acquisition and maintenance of affiliative bonds.

8.2.1. Acquisition of affiliative bonds. As Figure 12 indicates, for any given affiliative stimulus, the degree of *state* (contemporaneous, stimulus-induced) μ -opiate response will, on average, be larger in individual *B* than individual *A*. Our proposal is that this is a major source of the neurobiological basis of the temperamental (i.e., nonexperiential) component of affiliative reward, and hence of variation in the acquisition of affiliative bonds, and ultimately in levels of trait affiliation. Because the degree of state μ -opiate activity is correlated with the magnitude of *subjective emotional experiences* that are naturally elicited by affiliative stimuli (i.e., increased interpersonal warmth, affection and kindness, gratification, pleasure, and peaceful calmness), this emotional experience is also predicted to be more enhanced in *B* versus *A* (Cleeland et al. 1996; Ferrante 1996; Greenwald et al. 1996; Olson et al. 1997; Schlaepfer et al. 1998; Uhl et al. 1999).

This difference between individuals *A* and *B* in magnitude of affiliative stimulus-induced *uOR* activation and accompanying subjective emotional experience may contribute to two important sources of variation in acquisition of affiliative bonds. First, as noted in section 8.1, independent variation in either of the two interactive variables that determine the threshold of affiliative reward (*uOR* activation and magnitude of affiliative stimulus) also, simultaneously, modifies the value of the other variable that is required to reach a minimum threshold of affiliative reward. This suggests that individual *B* will encode contemporaneously the magnitude of affiliative reward for any given affiliative stimulus as greater relative to individual *A*. Importantly, enhanced reward encoding would be expected, in turn, to affect the magnitude of positive affective representations of affiliative objects during subsequent acquisition and consolidation of social memory, thereby increasing incentive-driven approach to and affiliation with these objects (Damasio 1994; LeDoux 1998).

Second, if individual differences in reward encoding apply across the full range of magnitudes of affiliative stimuli, trait differences in *uOR* activation may have marked effects on the *range* of effective (i.e., reward- and behavior-inducing) affiliative stimuli. This is illustrated in Figure 12, where the right vertical axis represents the range of effective affiliative stimuli. Increasing trait levels of *uOR* activation (horizontal axis) are associated with an increasing efficacy of weaker affiliative stimuli and, thus, with an increasing range of effective affiliative stimuli. In Figure 12 individuals *A* and *B* are shown to have a narrow versus broad range, respectively. Significantly, the broader range for individual *B* suggests that, on average, *B* will experience more frequent elicitation of subjective emotional experiences associated with affiliative reward. This means that the probability at any point in time of being in a *u*-opiate-facilitated state for individual *B* is higher than it is for *A*. Therefore, when subsequent affiliative stimuli are encountered, their subjectively evaluated magnitude of affiliative reward will show a stronger positive bias for *B* than *A*. Thus, trait differences

in affiliative reward reflecting variation in *uOR* activation may *proactively* influence the reward evaluation and reward encoding of affiliative stimuli, and may not be restricted to *reactive* emotional processes (Bindra 1978).

This raises the possibility of variation in the *dynamics* of affiliative engagement with the environment. A positive relation between *state uOR* activation and affiliative stimulus efficacy suggests that, as an initial affiliative stimulus enhances *uOR* activation, the efficacy of subsequently encountered affiliative stimuli may be increased proportional to the degree of the initial *uOR* activation. Under conditions of strong *uOR* activation, perhaps even previously subthreshold affiliative stimuli may come to elicit affiliative reward for a period of time. This dynamic process of gradually rising affiliative reward might affect the degree of facilitation of affiliative behavior throughout the temporal course of the affiliative engagement, and hence the aggregate reward value encoded for the affiliative goal.

The overall manifestation of these various processes is likely to be more frequent and more affectionate interpersonal contact for individual *B* relative to individual *A*. If this reflects enhanced affiliative reward experienced by individual *B*, there is one additional effect of importance that involves the interaction of *u*-opiates and DA. As discussed in section 6.1.1, the magnitude of both unconditioned and conditioned rewards is strongly associated with the quantity of DA release in the NAS and with a graded increase in the frequency and duration of VTA DA neuronal activity (Blackburn et al. 1989; Nishino et al. 1987; Schultz 1986; Schultz et al. 1995b; White 1986). Moreover, DA neurons show increased activity in the presence of neutral stimuli that consistently predict reward (Schultz et al. 1995b; 1997). Thus, holding trait DA functioning constant, a broader range of effective affiliative stimuli, each with enhanced *uOR* activation-induced affiliative reward, is expected to produce more robust DA reactivity to affiliative reward in individual *B*. This effect follows from the fact, as discussed in section 6.3.2, that *u*-opiate projections from the arcuate nucleus significantly activate both VTA DA neurons and NAS DA functioning. Accordingly, an enhanced acquisition of a broader array of conditioned stimuli that are predictive of affiliative reward can be expected for individual *B*. Thus, variation in *uOR* activation by affiliative stimuli may not only influence the level of affiliative reward, but also may lead to variation in the strength of DA-facilitated associative processes that link neutral stimuli with affiliative reward, as well as DA-facilitated approach to affiliative objects. *The outcome of these interactions may be the acquisition of a more elaborate associative network linking reward to affiliative objects (infants, mates) in individual B.*

8.2.2. Maintenance of affiliative bonds. *Longer-term maintenance* of affiliative bonds in species that have a relatively long offspring developmental period, which is extreme in humans, presents complications beyond the mere *acquisition* and *short-term maintenance* of affiliative bonds. Perhaps the most significant development in humans that contributes to maintenance of affiliative bonds between mothers and infants and between mates is the unbinding of both maternal caregiving and sexual activity from the strict hormonal control of reproductive cycles (Keverne et al. 1997). This unbinding liberates affiliative reward mechanisms to operate continuously between mother and offspring and between mates. For example, unbinding permits

engagement in sexual activity between mates at any time, and hence increases its frequency, and thereby promotes two important factors: (1) prosocial and sexual tactile stimulation, which serves as the most potent source of stimuli that activate affiliative reward; and (2) conditioning of the mate's personal features to affiliative reward, thereby enhancing the establishment of mate preference. These factors would be enhanced, as well, by the human social strategy of monogamy, which increases nonsexual and sexual tactile interactions and other behavioral dependencies required for offspring care and survival of nuclear family members. Furthermore, perhaps in tandem with the release of sex from reproductive hormonal control is the enhancement of the external manifestation of physical sexual attractors in humans, including female breasts and male penis. Additionally, social group living in humans also would increase nonsexual tactile stimulation, and perhaps has extended the utility of an affiliative reward mechanism to create less intense but more enduring bonds between members of a social group as a means of promoting group cohesion.

Individual differences in the maintenance of affiliative bonds in humans may relate to the very factors that promote acquisition of affiliative bonds. As stated in section 6.3.2, variation in *uOR* activation by affiliative stimuli may not only influence the level of affiliative reward, but also may lead to variation in the strength of DA-facilitated associative processes that link neutral stimuli with affiliative reward. The latter would be expected to result in variation in the breadth and strength of the encoded *network* of conditioned positive incentives that represent the general context and specific features associated with affiliative objects. These factors may lead to variation in the long-term encoding of the reward magnitude of affiliative objects in memory, resulting in consistent differences in the intensity of positive affective central representations of affiliative objects (Mishkin 1982). Such differences could have marked effects on the maintenance of affiliative behavior through the operation of cognitive processes of working memory integrated in prefrontal cortical regions. In prefrontal regions, central representations of the salient context, the affiliative object, prior response strategies, and their association with reward can all be held on-line as a means of: (a) "reliving" affiliative interactions and reward, despite gaps in space and time, and (b) motivating approach to the affiliative object via symbolic central representations (Brothers & Ring 1992; Damasio 1999; Goldman-Rakic 1987; Rolls 1999; Waterhouse et al. 1996). Subsequent to approach, repetition of affiliative reward processes would then further reinforce the affiliative bond (Di Chiara & North 1992; Insel & Winslow 1998). This sequence is likely critical to the enduring nature of affiliative bonds in humans, because repeated interactions are vital for their maintenance. For example, prairie voles show a significant preference for a familiar partner up to 8 days of separation, but by 10 days of separation they do not exhibit a significant preference for the partner, and by 2 weeks they treat formerly familiar and preferred voles as strangers (Carter et al. 1995). In humans, *recognition* of the individual is not lost, but the incentive salience of an affiliative bond can be degraded and the relationship threatened after prolonged separation (Dellmann-Jenkins et al. 1994). Thus, individuals *A* and *B* may develop *differences in their capacity to facilitate over time affiliative reward and affiliative approach behavior by cen-*

tral incentive representations of affiliative objects and their contexts.

Finally, individual *A* is predicted to exhibit less resistance to extinction relative to *B* in situations where affiliative reward is relatively weak, intermittent, or based on delayed gratification. This is because of: (a) weaker contemporaneous encoding of affiliative reward, and (b) a weaker network of conditioned incentives to activate affiliative approach behavior and affiliative reward by central representations. Importantly, such reward conditions represent those that exist at critical times of affiliative bond formation and maintenance, such as in the beginning of bond formation (weaker and/or intermittent reward) and during times of separation from affiliative objects (intermittent reward and delayed gratification). As these various "obstacles" to reward increase, individual *A* is predicted to show earlier extinction of affiliative approach behavior, and hence less frequent intimate contact with the affiliative object than individual *B*, both of which should reduce maintenance of affiliative bonds.

8.3. Preliminary support for opiate involvement in trait affiliation

We have begun to study the association of opiate functioning with a human trait of affiliation. From a sample of 2981 college students who all took Tellegen's MPQ, including the Social Closeness (SC) scale, we randomly selected high SC (top decile) and low SC (bottom decile) females (19–21 years of age; 47–70 kg). Structured interview ruled out DSM-IV psychiatric and medical disorders, smoking, use of birth control pills, and pregnancy. General experimental controls included circadian (subjects were run between noon and 3 PM), menstrual cycle (subjects were run in the mid-follicular phase, days 5–12 after initiation of bleeding), and fasting from midnight the previous night. The general experimental approach involved assessing two dependent variables: (a) *state* affiliation ratings and (b) tolerance to heat, both measured after viewing either a film clip that specifically induces an affiliative subjective experience versus a neutral film clip of a rain forest. In addition, these film-induced changes in the two variables were measured under two drug conditions: placebo and an opiate antagonist.

8.3.1. Dependent variables. We used an affiliation rating scale that was demonstrated to be sensitive to the affiliative film material used here (i.e., showed significant changes after the affiliative film but not after the neutral film), and which correlated significantly with SC but not with any other MPQ scale (Morrone-Strupinsky et al. 2000; Morrone-Strupinsky & Depue 2002). The scale uses the two strongest adjectival markers defining an affiliation factor – *warm* and *affectionate* – to characterize the emotional nature of the rating scale (Goldberg & Rosolack, 1994). We did not designate adjectives of increasing magnitude as anchors for each point of the rating scale, because a full complement of affiliative adjectives scaled for intensity has not been well differentiated. Instead, on the basis of extensive preliminary work, we devised a 7-point scale entitled Warm and Affectionate, in which each of the 7 points was labeled by a modifier of increasing magnitude, *from not at all* (0) to *completely* (6). Ratings of the Warm and Affectionate scale were current state ratings introduced by "Rate how you currently

feel in comparison to the highest level indicated on the rating scale.” Heat tolerance was chosen as a dependent variable because it is a well-established measure of μ -opiate activity in animals, is blocked by naltrexone, and is correlated with reward effects of opiates, although the u OR subtype may differ for the two effects (Carlezon et al. 2000; Stefano et al. 2000; Uhl et al. 1999; Wilson et al. 2000). Our interest in assessing pain tolerance also arose from the significant difference ($p < .01$) we previously found between 30 high SC and 30 low SC females in self-reported menstrual pain (assessed on a standard questionnaire as a summed score on six 6-point rating scales, ranging from “none” to “intense, disabling,” for muscle stiffness, headache, cramps, backache, fatigue, general aches and pains).

8.3.2. Film material. The 15-minute affiliative film clip portrayed the development of a close mate relationship (without sex scenes) as they encounter struggles and joys while they are expecting their first child and after the birth of their child. A 30-second verbal synopsis of the film’s story line (without conveying final events) appended to the beginning of the film clip provided a contextual framework for the clip, and any relevant information on the identity of the main protagonists. In this way, the film’s story and characters had immediate specific meaning for subjects. The affiliative film was found to induce strong, significant changes in ratings of warmth and affection, that were specifically and significantly associated with MPQ SC, but not with any other MPQ scale including agentic extraversion (Morrone-Strupinsky & Depue 2004; Morrone et al. 2000). The neutral film was a 10-minute narrated segment of tropical rain forest scenes and had no significant effect on ratings of warmth and affection (Morrone et al. 2000).

8.3.3. Heat tolerance. Heat tolerance estimation involved placing the nondominant hand on a plexiglass plate located over a high-intensity light source. Extensive pilot work guided by pain experimental literature evolved the following method: Every 30 secs, subjects rated their intensity of heat-induced pain on a 7-point scale, for a maximum of 5 minutes

to avoid skin damage. Subjects also reported verbally: (a) first detection of “painful,” and (b) “stop” with removal of their hand. The first report indicates the time to pain detection, and the second indicates time to tolerance of pain. Of course, it is not possible to separate pure physiologic pain detection and tolerance from psychological factors, because they are essentially nonseparable aspects of pain in self-report under natural conditions (Zubieta et al. 2001).

We have measured Social Desirability via the MPQ, and 20 high and 20 low SC subjects did not differ significantly ($p > .40$), nor did SC correlate with Social Desirability ($n = 2000, r = .07$), so it is unlikely the groups differed in degree of self-esteem, diffidence, or wishing to *please* the experimenter. No significant group differences were found in pain detection level (i.e., level of 4 on the rating scale), or in time of reaching that detection level, on the heat feelings rating scale in any condition. Therefore, the results focus on tolerance.

8.3.4. Opiate antagonist. The opiate antagonist naltrexone (NT) was used to demonstrate an opiate relation to the dependent variables. NT (ReVia) is a potent opiate antagonist that has high affinity for μ -opiate receptors (u ORs) and has no opiate agonist properties (Carroll et al 2001; Katzen-Perez et al 2001; Kim et al. 2001; McCaul et al 2001; Sathe et al 2001). NT can be administered orally, has no interaction with food or beverages, is not habit-forming, has a benign adverse effect profile no different from placebo at doses below 50 mg/day, does not require nutritional support, and tolerance to NT is not known to occur. NT undergoes rapid and nearly complete absorption with approximately 96% of the dose absorbed from the GI tract. NT plasma levels correlate with NT dose ($r = .88, p < .01$). On average, and equally for both males and females, a 25 mg oral dose of NT reaches peak blood concentration in 1 h, the mean elimination half-life value is 3.5 h, and NT reduces positive mood state in normal subjects within 45 min of oral administration. Importantly, in humans NT blocks the rewarding and tension-reducing effects of alcohol, morphine, and sexual orgasm, and the euphoric subjective ef-

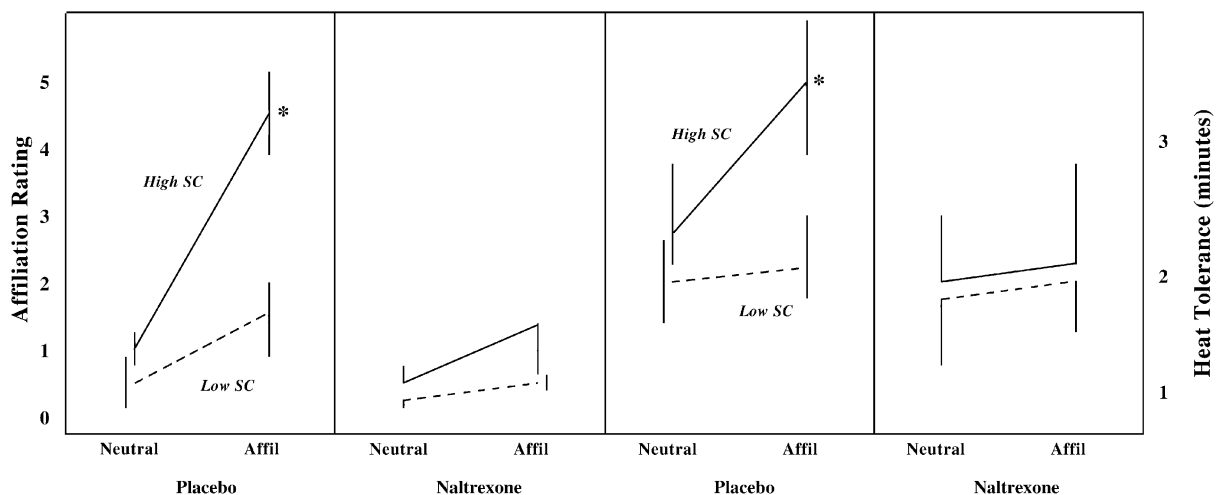

Figure 13. Preliminary data showing that: (a) affiliative film material induces a stronger state of warmth and affection (left half of figure) and heat tolerance (right half of figure) in subjects who are high versus low in trait affiliation on Tellegen’s Social Closeness (SC) scale under placebo conditions, and (b) elimination of these differences between groups under administration of the opiate antagonist naltrexone. See text for details. (Abbreviations: Neutral = neutral film condition; Affil = affiliative film condition).

fects of opioids, all of which are mediated largely by μ ORs (Uhl et al 1999). NT also blocks the development of vaginocervically-induced mother–infant bonds in sheep, causes maternal neglect in monkeys (Keverne 1996), blocks a preference for a novel odor or taste paired previously with morphine (Blass 1992), and blocks the establishment of odor–mother and male–female recognition associations in rodents (Leyton & Stewart 1992; Nelson & Panksepp 1998; Panksepp 1998). We used 25-mg oral doses.

Fifteen high SC (top decile) and 15 low SC (bottom decile) females were run in two randomized, cross-over, double-blind drug conditions (separated by a 4-day interval) of placebo (lactose) and 25-mg oral NT (identical gel capsules were used for the two conditions). Both conditions involved watching in counterbalanced order neutral and affiliative film segments (separated by a 10-min interval) in both drug conditions. After each film segment, affect ratings (also measured before each film) and heat tolerance were assessed. The left half of Figure 13 shows the increase in affiliation ratings induced by the affiliative film relative to the neutral film in both drug conditions. A 2 Groups \times 2 Films \times 2 Drugs ANOVA with repeated measures on the last two factors showed a significant 3-way interaction ($F = 17.4, p < .01$). Post-hoc Tukey testing of the *placebo* condition data showed that high SC subjects significantly increased their affiliation ratings to the affiliative film relative to the neutral film ($p < .01$), whereas low SC subjects showed no significant increase in affiliation ratings ($p > .30$). Moreover, the affiliative ratings to the affiliative film were significantly higher in the high SC versus the low SC subjects ($p < .01$), whereas the groups did not differ significantly in ratings to the neutral film ($p > .20$). That opiates may be involved in the film-induced increased affiliation state under placebo conditions in high SC subjects is suggested by the lack of significant increase in ratings by the high SC subjects to the affiliative film relative to the neutral film in the NT condition ($p > .30$). Indeed, in the NT condition, high and low SC groups are statistically indistinguishable for either film.

The right half of Figure 13 shows the increase in heat tolerance (time to “stop”) induced by the affiliative film relative to the neutral film in both drug conditions. The significant 3-way interaction ($F = 12.7, p < .05$) mirrors the affiliation rating data: In the *placebo* condition, Tukey testing showed that (a) high SC subjects show significantly greater increases in heat tolerance after the affiliative film relative to the neutral film ($p < .01$), whereas the low SC subjects show no significant rating changes ($p > .30$), and (b) high SC subjects have significantly higher heat tolerance scores after the affiliative film than low SC subjects ($p < .01$), but the groups do not differ after the neutral film ($p > .30$). However, in the NT condition, these various comparisons show no significant differences between high and low SC subjects.

Thus, NT-induced blockade of opiate receptors eliminates the significant effects of affiliative film material on affiliative ratings and heat tolerance on high SC subjects, such that the high and low SC groups become statistically indistinguishable for either film. This suggests that the differences between high and low SC subjects in affiliative stimulus-induced feelings of affection and warmth and heat tolerance are in part a result of variation in opiate functioning. Although differences between the two groups do not appear to be related to social desirability and its correlates (self-esteem, diffidence), other unmeasured factors that might affect affiliative ratings to affiliative film mater-

ial (e.g., attachment styles, rejection sensitivity, mate experiences) need to be controlled in future research.

9. Concluding remarks

There is a great paucity of *human* neurobiological research on traits that comprise the broad domain of interpersonal behavior, although animal research over the past decade has provided a significant foundation for such work (e.g., Carter et al. 1997) and human social neuroscience is an emerging field (Cacioppo et al. 2002). As a social animal, such human interpersonal traits influence some of the most important aspects of our existence, particularly the social relationships that are crucial to the survival of ourselves and our offspring, such as those between mother and infant, sexual mates, and close friends in small groups. We have argued that an affiliation trait based on an underlying process of u -opiate-mediated reward is a critical element in determining variation in affiliative behavior, because u -opiates appear to influence both the basic reward sensitivity to affiliative stimuli, and hence variation in the development of associative memory networks that support the acquisition and maintenance of affiliative preferences and bonds.

An important caveat in considering our modeling is that our analysis relies very heavily on literature from rodent studies, mainly because that is where most of the relevant data currently exist. The primate brain and primate social life are substantially more complex than that of the rodent, suggesting that the hypothetical links between animal and human suggested in the analytic strategy in Figure 2 be drawn with great care and eventually with empirical support. It might be asked, for example, what maternal care or partner preference in rodents shares with the concept of affiliation in humans, as assessed for example by the trait of social closeness (Tellegen & Waller, in press). We are not arguing that there is strict isomorphism between animal and human affiliative behavior, or that rodent affiliative behavior directly informs human social closeness as a concept. Rather, we have attempted to use the rodent literature to define more basic associations between affiliative stimuli, neurobiology and neurochemistry, and affiliative behavior including social memories, and then to apply these associations to human affiliation. One example of such a basic association is the relation between affiliative stimuli (e.g., gentle tactile stimulation) and u -opiate-mediated reward. It is likely, of course, that there exist more complex influences on these associations by other neurobiological modulators and social behavior in humans, influences that will obviously need to be empirically discovered in subsequent human research. A recent study, however, is supportive of our general strategy: Based in part on associations observed in the rodent neurobehavioral literature, the study demonstrated a similar regulation of human affective responses by similar neuroanatomical brain regions and limbic u -opiate mechanisms (Zubieta et al. 2003).

Of course, models of personality traits based on one neurotransmitter or neuropeptide, such as u -opiates, are clearly too simplistic, and will require the addition of other modifying factors (Ashby 1996; Depue & Collins 1999). In our model, the central u -opiate projection system is only one, albeit predominant, contributor to affiliative reward and bonding, and we attempted to specify the specific roles of DA, OT, vasopressin, gonadal steroids, and the rostral

Study	Numbered trait abbreviation (in numerical order)	Corresponding personality questionnaire trait ^a
Tellegen & Waller (in press)	WB1	Tellegen Multidimensional Pers. Q., Well-Being
	Dom2	Tellegen Multidimensional Pers. Q., Social Potency
	Ach3	Tellegen Multidimensional Pers. Q., Achievement
	Affil4	Tellegen Multidimensional Pers. Q., Social Closeness
	Ach5	Personality Research Form, Achievement
	Affil6	Personality Research Form, Affiliation
	Dom7	Personality Research Form, Dominance
	Persis8	Personality Research Form, Endurance
	Affil9	Personality Research Form, Exhibition
	Nurtur10	Personality Research Form, Nurturance
	Play11	Personality Research Form, Play
	Affil12	Personality Research Form, Social Recognition
	Succor13	Personality Research Form, Succorance
Church 1994	Affil14	Costa & McCrae NEO, E1 – Warmth
	Affil15	Costa & McCrae NEO, E2 – Gregariousness
	Dom16	Costa & McCrae NEO ^b , E3 – Assertiveness
	Act17	Costa & McCrae NEO, E4 – Activity
	Excit18	Costa & McCrae NEO, E5 – Excitement Seeking
	PE19	Costa & McCrae NEO, E6 – Positive Emotions
	Affil20	Costa & McCrae NEO, E7 – Agreeableness
	WB21	Tellegen Multidimensional Pers. Q., Well Being
	Dom22	Tellegen Multidimensional Pers. Q., Social Potency
	Ach23	Tellegen Multidimensional Pers. Q., Achievement
Affil24	Tellegen Multidimensional Pers. Q., Social Closeness	

^aReferences for the trait measures may be found in the study that used them.

^bNEO = Neuroticism–Extraversion–Openness; Pers. Q. = Personality Questionnaire.

circuit of the MXA in affiliative processes. Clearly, though, individual differences in: (a) neurobiological modulators of *u*-opiate functioning (see Fig. 12), (b) nonopiate neurobiological processes associated with other traits of interpersonal behavior (e.g., separation anxiety, agentic extraversion), and (c) social experience (Meaney 2001) will all represent error variance in predicting trait affiliation from *u*-opiate functioning alone. However, we believe that despite the complexity inherent in the neurobiology of temperament and personality, there is good reason to attempt to specify the role of one major neurotransmitter or neuropeptide, explore the details of its relation to other neurobiological variables and to personality traits, and gradually build complexity by adding additional factors one at a time. In this way, neuromodulator models of complex behavior patterns may serve as important building blocks for more comprehensive models of personality traits.

ACKNOWLEDGMENTS

This work was supported in part by NIMH Research Grant MH55347, awarded to R. A. Depue, and NIMH Postdoctoral Fellowship F32 MH64265, awarded to J. V. Morrone-Strupinsky. We wish to express our deep appreciation to Auke Tellegen for his insightful discussions on the nature of affiliation, which stimulated the initiation of this target article, and for his careful work on the measurement of affiliation, particularly the higher-order trait of Social Closeness in his Multidimensional Personality Inventory that was used in the study reported herein.

Open Peer Commentary

Affiliative drive: Could this be disturbed in childhood autism?

Ralf-Peter Behrendt

Department of Psychological Medicine for the Elderly, Barwise, Walton Hospital, Chesterfield, S40 3TH, United Kingdom.
rp.behrendt@btinternet.com

Abstract: Affect mirroring allows infants to distinguish emotional and intentional states of significant others, which – in the pursuit of their own drive satisfaction, including satisfaction of the affiliative drive – become important contextual stimuli predictive of reward. Learning to perceive and manipulate others' attitudes toward oneself in pursuit of affiliative reward may be an important step in social development that is impaired in autism.

Depue & Morrone-Strupinsky (D&M-S) acknowledge that, apart from affiliation, social cooperation involves several motivational processes including social dominance (agency), competitive aggression, and avoidance of social isolation. Social integration emerging from these processes increases the individual's abilities to satisfy a number of basic needs (drives), such as those pertaining to shelter, food, or mates. In social groups, strategies for the satisfaction of a variety of drives do not only involve the physical presence of conspecifics or their coincidental pursuit of similar ac-

tivities, but importantly rely on active cooperation between individuals, which means that conditions for drive satisfaction have to become associated through learning with the perception of emotional and intentional states of conspecifics. Thus, the development of social cooperation in a group would also involve the ability to perceive others' mental states.

Sensory features of conspecifics that are predictive of affiliative reward may include a smile and a particular tone of voice, as pointed out by D&M-S, but also attentive and caring eye contact. There may well be different inborn predispositions to perceive these features, which, however, may acquire incentive value only through association with the empathetic experience of others' emotional states and contingent affiliative reward. Infants are born with a bias to preferentially track and fixate stimuli with face-like configurations (Johnson et al. 1991; Valenza et al. 1996). Initially, these stimuli lack meaning for the infant; but innate propensities guide learning and ensure that the developing brain receives more input from the social aspects of the environment (Johnson 2001). Newborns are also biologically predisposed to express certain emotional states by facial expressions, vocalizations, and gestures (Izard 1994). Short face-to-face interactions between mother and infant emerge around the age of 2 months. During these interactions, mother and infant attune to each other's affective expressions; that is, they synchronize their affective behaviors (Feldman et al. 1999). These synchronized interactions between maternal and infant affective states are crucial for the infant's further social development and emergence of self-control (Feldman et al. 1999). Adolphs et al. (2000) suggested that we recognize the emotional state of others from their facial expression by internally generating somatosensory representations that simulate how the other individual would feel. An inborn tendency to imitate may allow the infant to re-experience emotional states of conspecifics and learn about the association of these states with the delivery of affiliative and other rewards. Thus, the caregiver's emotional states may become contextual stimuli that have incentive value, allowing the infant to develop conditioned preference to experience certain emotional states of their caregiver.

Inborn perceptual preferences or the tendency to imitate others may be disturbed in childhood autism. Children with autism are slower in establishing a new focus of visual attention (Harris et al. 1999), show weaker gaze engagement with a target (van der Geest et al. 2001), and make more frequent saccadic eye movements in passive viewing tasks (Kemner et al. 1998). Abnormalities in the visual attention system may be the cause of social deficits in autism (van der Geest et al. 2001) insofar as infants would be deprived of opportunities to learn (Kemner et al. 1998) about the relationship between the caregiver's facial expressions, their own motivations, and situational characteristics. Structural and histopathological abnormalities in the cerebellum, particularly affecting the neocerebellar vermis lobules VI–VII, have been reported consistently in patients with autism (Couchesne et al. 2001; Kemper & Bauman 1998) and have been associated with deficits in orienting to visual cues (Harries et al. 1999; Townsend et al. 1999). Along with social deficits, children with autism also show a decreased tendency to explore new environments, which again was associated with hypoplasia of vermal lobules VI–VII (Pierce & Couchesne 2001). The hypothesis that lack of imitative interaction can lead to autism is supported by observations that later exposure to imitative interaction can bring about an increase in distal and proximal social behaviors (Escalona et al. 2002; Field et al. 2001).

One could argue that autistic children's specific problem in orienting toward human stimuli, which may represent the primary manifestation of the pathological process in autism (Maestro et al. 2002), is more indicative of the fact that the perception of such stimuli is not associated with reward experience or drive satisfaction. Autistic children may not have a general problem with perception but cannot recognize the emotional and contextual meaning of facial expressions, gestures, and vocalizations (Hobson 1986). As discussed by D&M-S, central oxytocin and vasopressin

from the paraventricular nucleus of the hypothalamus are involved in the appetitive phase of sociosexual and affiliative behaviors, their release being elicited by a wide range of unconditioned and conditioned affiliative and sociosexual stimuli. In the authors' words, oxytocin and vasopressin, as well as gonadal steroids, ensure that affiliative stimuli are weighted as significant elements in contextual ensembles representing affiliative memory networks. Given that the formation of social recognition memories depends on oxytocin receptor activation in the medial extended amygdala, lack of oxytocin or a disorder of the amygdala could impair learning of associations between contextual stimuli and affiliative reward. In autism, there is evidence early in life for abnormalities in processing of the oxytocin precursor peptide (Green et al. 2001), resulting in failure of the normal increase of oxytocin plasma concentrations with age (Modahl et al. 1998), and neurodevelopmental abnormalities affecting the amygdala (Aylward et al. 1999; Bauman & Kemper 1985; Sparks et al. 2002). Moreover, lesioning the amygdala in monkeys shortly after birth results in a similar pattern of social isolation, lack of eye contact, and expressionless face, indicating inability to appreciate the motivational significance of social stimuli (Machado & Bachevalier 2003; Schultz & Klin 2002).

"Theory of mind" refers to an individual's cognitive ability to understand or "represent" other peoples' states of mind, especially their beliefs and intentions. Lack in "theory of mind" is thought to be the core psychological deficit in autism (Baron-Cohen et al. 1985). Perception of others' mental states is undoubtedly important for social behavior, however "theory of mind" accounts of autism may be misguided in focusing on cognitive-verbal aspects of this awareness, which are likely confounded by disabilities in executive functioning. Performance deficits in "theory of mind" tasks are not specific for autism (Pennington & Ozonoff 1996; Rowe et al. 2001), and progressively less so with increasing mental retardation. It has indeed been considered that the root of "theory of mind" normally lies in infants' early tendencies to pay attention to human faces and language and respond to affective expressions (Tager-Flusberg et al. 2001) – stimuli that are attended insufficiently in autism possibly because they fail to acquire incentive value in relation to affiliative reward.

Social bonds, motivational conflict, and altruism: Implications for neurobiology

Stephanie L. Brown^a and R. Michael Brown^b

^aInstitute for Social Research, The University of Michigan, Ann Arbor, MI 48106; ^bDepartment of Psychology, Pacific Lutheran University, Tacoma, WA 98447. stebrown@umich.edu brownrm@plu.edu

Abstract: Depue & Morrone-Strupinsky (D&M-S) do not address how a reward system accommodates the motivational dilemmas associated with (a) the decision to approach versus avoid conspecifics, and (b) self versus other tradeoffs inherent in behaving altruistically toward bonded relationship partners. We provide an alternative evolutionary view that addresses motivational conflict, and discuss implications for the neurobiological study of affiliative bonds.

There is much to admire in Depue & Morrone-Strupinsky's (D&M-S's) presentation. Their attempt to bridge the gap between psychometric constructs of human trait affiliation and affiliation in nonhuman animals is noteworthy. And their account of how appetitive and consummatory reward processes interact to produce changes in social memory is a novel, detailed, and exciting journey into the inner workings of the mind, with important implications for how we come to feel love for others. The major concern we have with the D&M-S proposal is one of balance. The model's dissociation of affiliation from "agency" and the authors' preoccupation with the "warmth" dimension of affiliation yield an incomplete and potentially misleading picture of social behaviors that occur prior to, during, and following the formation of social bonds,

and of neural requirements for mediating bond-relevant behaviors. Most important, D&M-S fail to address motivational dilemmas associated with bonding and with altruistic behavior that often occurs in the context of bonded relationships.

Rewards of bonding in context. Bond formation is not simply a matter of individuals participating in a rewarding prenuptial ceremony, punctuated by displays of social behavior and experiences of “relaxation and satiety.” There are potentially serious costs involved when two or more individuals are “brought together for an affiliative exchange,” including time and energy spent advertising one’s territory or signaling one’s level of dominance (or submissiveness), interference with access to resources, and, in some cases, death (Alcock 2001). Indeed, for many species, initial responses to the approach of conspecifics include aggression or other forms of rejection (Eibl-Eibesfeldt 1975). Taking an evolutionary perspective, we would expect social animals to have evolved sensitivities (e.g., emotional reactions) to *both* the costs and benefits of social interaction and, as a result, to experience approach versus withdraw motivational conflicts in a variety of social situations.

D&M-S describe the neural circuitry that *could* accommodate *both* negative and positive emotional experiences associated with social encounters – mainly the amygdala and its projections. But they discuss these structures only in terms of reward and the enhancement of reward-based affiliative memories. By so doing the authors paint an overly simplistic view of social interaction and bonding and, in our view, miss a golden opportunity to extend their model to the resolution of affiliation-related motivational conflict. For example, they might have drawn on the work of Gray and colleagues, which suggests that either positive or negative emotion can modulate neural mechanisms that support cognitive control, including the resolution of approach versus withdraw dilemmas (Gray 2001; 2004; Gray et al. 2002).

Social bonds, maternal behavior, and other forms of altruism. Social motivational dilemmas are not restricted to approach and the preliminaries of bond formation. Human social bonds, once formed, are characterized by acts of altruism. Examples include expending considerable time and energy to raise children, forgoing favorite activities or social opportunities, or both, to spend months by the bedside of a terminally ill mate, compromising one’s own health and well-being to provide continuous care to an elderly or sick relative or friend, and risking injury and death on a daily basis to protect comrades in times of war. Such behaviors provide significant benefits to others (in some cases the preservation of life), but at a cost to the altruist (in some cases death). Because of this, self versus other motivational conflicts are expected (Sober & Wilson 1998), and bond-relevant neural circuitry must be able to accommodate these conflicts and their resolution.

D&M-S fail to address altruistic motivational conflicts in the context of close relationships, but they do address altruistic behaviors. Specifically, they imply that the very same reward mechanisms hypothesized as necessary for affiliation – mainly opioids – are sufficient for maternal nurturance (sect. 3.2.1.). Although we do not dispute the idea that the involvement of opioid production in the ventral tegmental area (VTA) may be crucial for some bonding behaviors, such as reducing aggression toward conspecifics, forming partner preferences, and facilitating social memory, we disagree with equating the neurobiology underlying these types of processes (reward mechanisms) with the neurobiology that may characterize maternal behavior (MB) or other types of parental or altruistic behavior. Although a few studies link opioid production in the VTA to decreasing the latency for the onset of MB (e.g., Thompson & Kristal 1996), the research picture on opiate involvement in MB is mixed (Thompson & Kristal 1996). Many studies demonstrate, for example, that opioids *inhibit* or *eliminate* MB (e.g., Wellman et al. 1997), and there is evidence to suggest that the locus of these inhibiting effects is the medial preoptic area (MPOA) (e.g., Mann et al. 1990), which is also a critical brain region for maternal behavior in rats (Numan 1988). Findings such as these raise the possibility that a reward system could actually interfere with (or suppress) MB and other forms of altruism.

A view of social bonds that addresses altruism and motivational conflict. Neural mechanisms for bonding should be tied to a clear conceptualization of a social bond and its functions. D&M-S characterize a bond as a “social attachment” (e.g., between infant and parent) and emphasize its security function. So it is not surprising that they focus on positive affect associated with security, and reward mechanisms that lead to the formation of secure attachments. Alternative conceptualizations of social bonds are possible, and they may have very different implications for neural bonding mechanisms. For example, we think of the social bond as a dynamic memory structure that produces a relatively stable affinity for another individual, and that functions to *suppress self interest in favor of prioritizing and investing in the well-being of mutually dependent relationship partners* (Brown 1999; Brown & Brown, in press; Brown et al. 2003).

Our account is evolutionarily based; it focuses primarily on human social bonds, though not exclusively so; it recognizes the need to resolve self versus other motivational conflicts inherent in altruistic decision-making; it emphasizes the need for selectivity in bond formation as a solution for adaptive problems generated by altruism (cheating, exploitation); and it is consistent with neurobehavioral evidence that highlights a possible mediational role for oxytocin (OT). For example, OT, and possibly vasopressin and endogenous opioids, demonstrably linked to pair bonding and maternal behavior, may function to inhibit anxiety and, at the same time, facilitate affiliative behaviors and bonding (Carter 1998). Henry and Wang (1998) suggest that hormones such as OT regulate the cortisol stress response, thereby inhibiting self-preservative behavior associated with fight-or-flight motivation. Furthermore, results from experimental investigations suggest that OT is causally related to the onset of MB and other forms of altruism (Carter 1998; Insel 1992).

Both theory and research imply or state that, in some circumstances, certain reward mechanisms are suppressed, not enhanced, in order to support maternal care, self-sacrifice, and other forms of altruistic behavior (Brown & Brown 2004; Gray 2004; Keverne & Kendrick 1992; Ochsner & Gross 2004; Sober & Wilson 1998). D&M-S’s arguments do not address these motivational complexities, let alone suggest ways in which the underlying cognitive or emotional control problems can be resolved.

Conclusion. A view of affiliative bonding that relies exclusively on reward mechanisms (a) cannot easily accommodate the motivational tradeoffs that are part of bonding and bond-related altruism, and (b) cannot easily address the selective nature of social bonds. Our evolutionary view of social bonds is not inconsistent with reward sensitivity as a necessary precondition for forming affiliative bonds. At the same time, our view also accommodates the altruistic and self-sacrificing behavior that typically occurs between close relationship partners. Placed in the context of evolutionary logic, our view also specifies with whom selective bonds should occur (kin and potential reciprocal altruists), an issue not addressed in the D&M-S model. Nonetheless, their model lays out the means by which rewarding affective processes that underlie selective preferences might lead to long-term changes in memory that support an altruistic function of social bonds.

Neuropeptides influence expression of and capacity to form social bonds

C. S. Carter,^a K. L. Bales,^b and S. W. Porges^a

^aDepartment of Psychiatry, (MC 912), University of Illinois at Chicago, Chicago, IL 60612; ^bDepartment of Psychology, University of California, Davis, CA 95616. scarter@psych.uic.edu kbales@ucdavis.edu sporges@uic.edu

<http://sandtiger.dbs.ucdavis.edu/FacultyProfiles/AnBehGG/DisplayFacultyProfile.cfm?ResearcherID=1966>
<http://www.psych.uic.edu/faculty/porges.htm>

Abstract: In the present commentary we expand on two concepts relevant to understanding affiliative bonding. Differences and similarities between the functions and actions of oxytocin and vasopressin are difficult to study but may be critical to an understanding of mechanisms for social bonding. What is termed here a “trait of affiliation” may reflect in part the capacity of these same peptides to program the developing nervous system.

As is well-documented by Depue & Morrone-Strupinsky (D&M-S), the concept of affiliative bonding has acquired diverse meanings, ranging from neuroendocrine-based behavioral processes, measured by selective social behaviors, to individual differences and personality traits, which in turn may influence all aspects of social behavior. Recent neuroendocrine research using animal models (Carter et al. 1995) has revealed that both the immediate and long-lasting effects of social experience on the tendency to form social bonds are mediated, in part, by two ancient neuropeptides, oxytocin and vasopressin.

If we are to understand the biological basis of affiliative behaviors, a deeper understanding of the actions and interactions of oxytocin and vasopressin will be needed. For example, among the short-term processes affected by these neuropeptides are approach behaviors and appropriate reactions to novelty that are necessary to permit interactions with a social partner. Social recognition (Winslow & Insel 2004) and social engagement (Porges 2003a) are initial steps in social behavior and required for social bond formation; both are affected by oxytocin and vasopressin. Oxytocin, acting on various substrates including the hypothalamic-pituitary-adrenal (HPA) axis and sympathetic nervous system, can be a powerful anxiolytic agent, capable of modulating reactions toward either novel adults or infants (Carter 1998). Moderate levels of vasopressin also may be anxiolytic, but it is possible that at higher doses or through effects on different tissues – for example, peripheral baroreceptors – vasopressin may have different behavioral effects. In addition, a voluntary immobilization without fear may be a feature of affiliative behaviors including lordosis or kyphosis. The ability to immobilize without eliciting autonomic reflexes (such as syncope) can be facilitated by oxytocin (Porges 1998; 2003b). However, centrally active vasopressin, although capable of facilitating affiliative responses (Cho et al. 1999; Lim et al. 2004a; 2004b; Winslow et al. 1993), is generally associated with mobility and the activation of the sympathoadrenal systems that support motor behavior. Furthermore, because portions of the vasopressin system are androgen-dependent and some aspects of oxytocin’s functions are estrogen-dependent, knowledge of oxytocin and vasopressin has begun to suggest insight into the expression of sociality and into the nature of sex differences in social behavior and social bond formation (Carter et al. 1995; DeVries et al. 1996). Thus, it is unlikely that these two peptides have identical effects on either the organization or expression of social behaviors, but their differential properties remain poorly understood.

D&M-S have emphasized the “trait of affiliation.” Genetic differences are one source of variance in sociality (Lim et al. 2004a). But genetic differences are not sufficient to explain the individual variations in social behaviors that have been observed even in presumably simple organisms like voles (Roberts et al. 1998). There is increasing evidence that social experiences, especially in early life, may contribute to enduring changes in patterns of behavioral

responses, possibly including alterations in the capacity to exhibit social bonds (Bales & Carter 2003a; 2003b; Bales et al. 2003; 2004a) or other forms of social behavior (Levine 2001; Weaver et al. 2004). For example, when prairie voles are deliberately not disturbed during the pre-weaning period, subsequent tendencies to be either social or exploratory are reduced (Bales et al. 2003).

Remarkably, during early development the same peptides that are implicated in adult social behaviors appear to be capable of programming individual differences in sociality (Carter 2003). The capacity of these neuroendocrine systems to undergo long-lasting functional modifications presents an epigenetic model that may help to explain the origins of traits that have been called personality or temperament, or by D&M-S, those termed “affiliation traits.”

In prairie voles exposure to exogenous oxytocin during neonatal life has the capacity to facilitate a later tendency to form pair bonds (Bales & Carter 2003a), may reduce behavioral and neuroendocrine reactivity to a novel environment (Bales & Carter, unpublished data), and enhances subsequent hypothalamic synthesis of oxytocin (Yamamoto et al. 2004). In contrast, even brief neonatal exposure to an oxytocin receptor antagonist (OTA) may disrupt subsequent social behaviors, including the tendency to form social bonds, to exhibit parental behaviors, and to manage anxiety or stress. Many of the consequences of early peptide manipulations are sexually dimorphic and map to sex differences in behavior. Ongoing research (Bales et al. 2004b) has revealed that a single exposure to an OTA on the first day of life produces a long-lasting reduction in vasopressin (V1a) receptor binding in the extended amygdala and reductions in vasopressin synthesis in the paraventricular nucleus (Yamamoto et al. 2004) in males, but not in females. The androgen-dependence of hypothalamic vasopressin and the sexually dimorphic capacity of an OTA to down regulate both vasopressin receptors and vasopressin may help to explain the fact that OTA exposure was especially disruptive to male behavior. In contrast, in females, but not males, a single treatment with exogenous oxytocin produced reductions in V1a receptor binding in the lateral septum, medial preoptic area, and ventral pallidum. In males, early oxytocin exposure upregulated V1a receptors in the ventral pallidum. These changes in receptor binding are consistent with behavioral changes seen in these animals. There are also recent data relating the effects of vasopressin in the ventral pallidum to an increased tendency to form pair bonds (Lim et al. 2004b).

In contrast, postnatal exposure to either vasopressin or a vasopressin antagonist did not disrupt the capacity of prairie voles to pair bond. However, animals exposed to neonatal vasopressin, especially males, tended to become more aggressive, whereas aggression was very low in animals exposed prenatally to either control treatments or a vasopressin antagonist (Stribley & Carter 1999).

Taken together, these and other related findings (reviewed in Carter 1998; Carter & Keverne 2002) support the general hypothesis that social bonding is regulated in a species-dependent manner by both oxytocin and vasopressin in adulthood and also during development. Social experiences including those between adult and offspring, as well as between adults, are, in turn, mediated in part by long-lasting changes in neural systems that incorporate oxytocin and vasopressin. Adaptive changes in these systems, especially at the level of various peptides and relevant receptors, may help to explain individual differences in behavior.

The degree to which these findings might generalize to human behavior is not known. However, there is growing evidence that early experiences, including physiological and behavioral changes associated with pregnancy, birth, lactation, and the management of infants during the postpartum period have the capacity to produce long-lasting changes in behavior. Routine endocrine manipulations, including the use of exogenous oxytocin during labor and more recently the use of oxytocin antagonists, also hold the potential to influence the parent and offspring in ways that have not been investigated in humans. Even apparently simple decisions,

such as the amount of time that an infant is touched or receives other forms of social stimulation, hold the potential to retune the nervous system (Levine 2001; Weaver et al. 2004). For both practical and theoretical reasons, it is important to realize that the mechanisms underlying traits, such as capacity to form affiliative bonds, are dynamic and capable of being influenced by early experience, often through effects on the same systems that regulate sociality in adulthood.

The role of trait affiliation in human community

Michael Glassman^a and Cynthia K. Buettner^b

^aDepartment of Human Development and Family Sciences, Ohio State University, Columbus, OH 43210; ^bCollege of Human Ecology, Ohio State University, Columbus, OH 43210. glassman.13@osu.edu
buettner.16@osu.edu

Abstract: This commentary speaks to the relationship between Depue & Marrone-Strupinsky's (D&M-S's) concept of trait affiliation and affiliative memory and the formation of human community, especially among peer groups. The target article suggests a model for how and why dynamic communities form in a number of disparate contexts and under a number of circumstances.

The target article has important implications for thinking about sociability and the role of human community in both ontological human development and human evolution. There are two general ways in which Darwin's (1860) ideas of species development have been applied to the human condition. First, there is the idea that individual action and the particular genetic structure that underlie phenotype abilities are the driving force in species group maintenance and adaptability (so that the individual with the greatest phenotypic abilities has the genetic structure most valuable to the community). The human community is secondary and is dependent on the individual. This general perspective served as the basis for the eugenics movement in the early part of the 20th century and for a good deal of recent sociobiology theorizing (Dawkins 1976). The second way in which Darwin's theory has been applied is to place community at the forefront. The great adaptation of the human species is the ability to come together in communities and to employ specific qualities such as planning and coordination to solve problems that cannot be solved by separate individuals. Species-wide qualities nurtured by the community are more important than transient, individual genotype-based abilities. This second Darwinian perspective, centering on issues of sociability and mutual aid, was first introduced by the evolutionary theorist Petr Kropotkin (1902). It was also a perspective adopted by the Pragmatic movement in the early part of the 20th century (Mead 1956), and it has served as the basis for some recent sociobiology theories (Sober & Wilson 1998). We believe the Depue & Marrone-Strupinsky (D&M-S) article may help tip the balance in favor of the second, more community-oriented perspective.

First, we start where we disagree with the target article – that is, with the differentiation made between affiliation and sociability. The authors suggest that affiliation focuses on quality of relationships whereas sociability focuses on quantity. So, sociability is affected by human traits such as extraversion that have little or no correlation with affiliation. But Kropotkin's original conception of sociability stressed interaction that was based not on quality or quantity but on context (e.g., a specific situation or problem facing the species community). We believe that the authors' thesis of a two-step process of affiliation has more to offer than does Kropotkin's conception of sociability. Certain types of human interactions tend to draw humans together, with the process being both biological and historical. The authors point to a critical connection between the biological urge to engage in affiliative action

and individual human history, which helps explain how and why communities are formed through the process of sociability, and how this helps create the key human trait of identity (i.e., when affiliation merges with history, you are left with identity). This can have both positive and negative effects on the human condition. The authors allude to the idea that affiliation is neutral; that is, it is a quality that can lead to constructive human engagement (the reason it developed as a species-wide trait) but one that can also, dependent on the mixing of histories and the ecological circumstances, lead to destructive human interactions. The key is that humans are drawn together to form a community by traits that function in a prerational manner. Although it is rational that humans have greater adaptive abilities when acting together than when acting alone, this type of conscious decision-making rarely enters into initial community building. The direction the community takes after it comes together is based on a complex interaction of this prerational activity and the way it interacts with social history.

The target article suggests answers to two critical questions: why humans are drawn to each other, and why this occurs in a number of surprising, and even dangerous (for the individual) ecological circumstances. The authors suggest a two-step process to trait affiliation. The first step is when dopamine is released in the brain, whetting the human appetite for further, more intimate contact. This contact, when achieved, leads to intense gratification through the release of endorphins. There are any number of cues that can lead to the release of dopamine. Whatever the cues, once the second step reaches its apogee, the cues (may) become part of the individual's affiliative memory through suggesting the same type of gratification in future interactions. The cues that individuals are presented with, the possibility of a successful second step leading to gratification, will have long-term impact (perhaps lifelong) on the activities of the individual. What we find especially salient in this explanation for human development is that many of the cues suggested by the authors, as well as the possibility for gratification, are found in the peer group (e.g., flirtation, shared vernacular, intimate gesture). This is important for two reasons: Early communities are most easily created by those who share characteristics and aspects of identity, and the experiences in these early communities have an oversized impact on the communities individuals will be attracted to later in life because they serve as the baseline for affiliative memory. This is an important part of the group socialization theory championed by Harris (1995); that is, we are drawn to the early peer group and the microcommunity it represents and, in turn, our interactions in that peer group modify the psychological characteristics with which we are born. Thus, our genetic predispositions and our early affiliative experiences with the peer group regulate what communities we can be part of, and the role we play in them, throughout our lifetime.

Research shows that individuals are continuously drawn into communities of peers in a variety of circumstance (McPhail & Wohlstein 1983). A recent study (Buettner 2004) exploring celebratory riots suggests that amorphous dynamic communities form on the basis of some possible but unknown gratification – a possibility formed as a result of affiliative memory, as individuals recognize cues based on previous experience with peer groups. The potential for affiliating with peers overrides threats of potential harm and even punishment.

What we believe D&M-S show is that biological response to social cues is at least as important as cognitive response to social cues. The individual is not always trying to figure out what actions are to his or her own advantage, but is often drawn to community as a necessity. This can be positive, as when communities work together to solve a problem, or it can be negative, as when communities form to achieve some unknown and impossible gratification for its members. What is critical to consider in both situations is that human beings are constantly sending out and reading cues meant to draw us together. D&M-S give us a framework for understanding this process.

Affiliative bonding as a dynamical process: A view from ethology

Kosuke Itoh^a and Akihiro Izumi^b

^aCenter for Integrated Human Brain Science, Brain Research Institute, University of Niigata, Niigata, 951-8585, Japan; ^bDepartment of Behavioral and Brain Sciences, Primate Research Institute, Kyoto University, Kanrin Inuyama, Aichi, 484-8506, Japan. itoh@bri.niigata-u.ac.jp
izumi@pri.kyoto-u.ac.jp
<http://coe.bri.niigata-u.ac.jp/coedoc/index.html> (for K. Itoh)
<http://www.pri.kyoto-u.ac.jp/index.html> (for A. Izumi)

Abstract: Depue & Morrone-Strupinsky's (D&M-S's) implicit assumption appears to be that affiliative bonding is either strengthened or maintained with time; however, it is more realistic that it can also be weakened or destroyed by conflictive interpersonal interactions. Without specifying the mechanisms by which antagonistic stimuli deteriorate affiliative bonding, the model is incapable of accounting for the dynamics associated with this complex phenomenon.

The argument concerns the theoretical conceptualization of affiliative bonding. Depue & Morrone-Strupinsky (D&M-S) define affiliative bonding in the context of psychometric studies, where the high-order trait of affiliation represents an independent dimension in multidimensional personality space. From there, they delineate the core behavioral-motivational processes underlying this trait, around which their neurobiological model is constructed. A critical view from ethology – which takes a bottom-up, behavior-based approach for studying animal social interactions – is that such top-down approaches may overlook many of the behavioral dynamics underlying affiliative relationships in human and nonhuman primate societies. The ethological approach has a theoretical advantage in conceptualizing affiliation, because definitions of personality traits should ideally be based on explicit behaviors in the scientific study of personality (Itoh 2002).

Observations readily illustrate the complexity of the behavioral dynamics associated with affiliative bonding. *Ame futte ji kata-maru* is a Japanese idiom that literally means “After a rainfall, the ground gets firm,” and although it may at first seem counterintuitive, it truthfully illustrates the natural phenomenon of soil-hardening that occurs after water in the soil evaporates. This phrase is often used to refer to the apparently paradoxical tightening of interpersonal bonds that can occur after successful postconflict reconciliation. It suggests the possibly constructive role of conflictive events in strengthening social relationships and supports the view that affiliative bonding involves complex dynamics evolving around intricate interpersonal interactions (Vallacher et al. 2002). Cycles of aggression and postconflict reconciliation constitute an integral part of affiliative bonding, and are also found in nonhuman primates (de Waal 2000). Matrilineal kin in rhesus monkeys, for example, show greater frequencies of both affiliative and antagonistic interactions than is found between unrelated individuals (Bernstein et al. 1993). Aggressions between closely related individuals are often quickly followed by reconciliatory behaviors in many species of nonhuman primates (Aureli 1997).

These observations indicate that behavioral expressions of affiliative bonding involve complicated interindividual interactions marked by both affiliative and nonaffiliative episodes. The authors' model of the core behavioral processes that underlie the affiliation trait (target article, Fig. 3) falls short, however, of depicting the dynamics involved. In their scheme, affiliative bonding is strengthened and maintained through appetitive and consummatory phases of processing affiliative rewards, and hence it is a nondecreasing function of time (Fig. 1a). By contrast, and according to a more dynamical view, it can also get weakened, theoretically at least, in the course of time because of conflictive interactions (Fig. 1b).

From this perspective, one crucial component missing from D&M-S's model is a negative input mechanism. In addition to the mechanisms by which affiliative rewards increase affiliation (labeled as “activation” in the target article, Fig. 3), mechanisms by which antagonistic stimuli deteriorate affiliation would also need

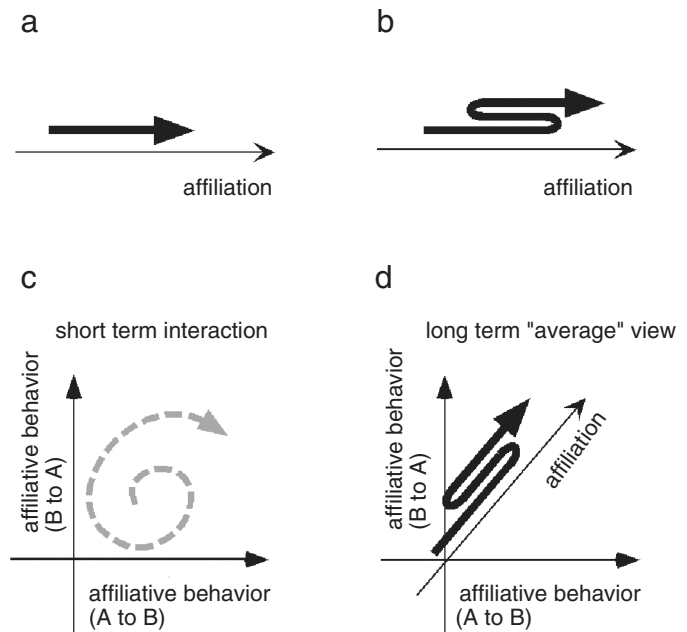

Figure 1 (Itoh & Izumi). Different conceptualizations of affiliative bonding. Affiliative bonding is a nondecreasing function of time in Depue & Morrone-Strupinsky's model (a), but it can also get weakened by conflictive interactions, according to a more dynamical view (b). In a behavior-based, dynamical formalization of affiliative bonding, short-term temporal dynamics associated with the affiliative quality/quantity of behaviors between two individuals map onto a two-dimensional “affiliation space” as a trajectory (c), and the temporal average of these short-term interactions represents the long-term affiliative bonding between those individuals.

to be modeled explicitly so that they can work as counteracting elements in the dynamics to “deactivate” affiliation. Moreover, yet another dimension of complexity is added by considering that affiliative bonding is, by definition, a relational property of not one but all individuals involved in the interaction. The significance of this notion is appreciated, for example, by recognizing that personality combinations can be important to affiliation. The difficulties that an individual undergoes in establishing an affiliative relationship with a particular individual do not necessarily indicate that he/she will have such a difficulty with another person.

To account for these points, the following conceptualization of affiliative bonding is suggested, in which an affiliative relationship between two individuals (A and B) is expressed in a two-dimensional “affiliation space,” as depicted in Figures 1c and 1d. The axes represent the affiliative quality/quantity of their behaviors directed at each other. Short-term temporal dynamics in their affiliative relations map onto this plane as a trajectory (Fig. 1c). Long-term mutual affiliation between two individuals can be considered as the overall tendency of the trajectory in Figure 1c to stay in the first quadrant at some distance from the origin, close to the 45-degree diagonal line. In this formulation, the affiliation trait is defined as the long-term “average” of the short-term behavioral interactions (Fig. 1d). This definition of affiliative bonding has the virtue of being dynamical, relational, and behavior-based. It is extendable to n dimensions, $n \geq 2$, if necessary.

How the short-term trajectory moves about in this two-dimensional space can be modeled, in dynamical systems theory (e.g., Strogatz 1994), by a set of equations

$$\begin{aligned} A(n+1) - A(n) &= f(A(n), B(n)) \\ B(n+1) - B(n) &= g(A(n), B(n)) \end{aligned}$$

where $A(n)$ = affiliative/antagonistic behavior of A against B at

their n th interaction, and $B(n)$ = affiliative/antagonistic behavior of B against A at their n th interaction.

Positive and negative values of A (or B) represent affiliative and antagonistic behaviors, respectively. These equations formalize the idea that temporal changes in affiliative quality/quantity of behaviors are dependent on the previous behaviors of both individuals involved. Functions f and g define the affiliative styles of A and B, respectively. Gottman et al. (2002) modeled marital relationships using this framework. An educational example of how love affairs between a man and a woman can be caricatured was presented by Strogatz (1994). The dynamical systems approach to studying social interactions and interpersonal bonds is receiving growing attention in human personality psychology (Vallacher et al. 2002).

The current conceptualization of affiliative bonding is quite different from that underlying D&M-S's neurobiological model. The utilization of personality inventory techniques for defining personality traits tends to average out temporal dynamics in behaviors, and therefore the top-down method for delineating core behavioral processes is not always justified. Another potential source for discrepancy is that the authors' model construction relied heavily on rodent data. Behavioral expressions of affiliative bonding may be more straightforward in rodents than in primates. The use of inventories and animal models under the strategic framework of the target article's Figure 2 is a legitimate approach in studying the neurobiology of personality traits (Itoh 2002). Nonetheless, inasmuch as the ultimate goal is to understand the affiliation trait as expressed in human behavior, it would eventually become necessary for the model to adapt to a conceptual framework in which affiliative bonding is regarded as a temporally dynamic, social phenomenon. In this admittedly daunting exploration, the neurobiological study of affiliative bonding would benefit from an incorporation of the behavior-based view of ethology and mathematical tools in dynamical systems theory.

Opioid bliss as the felt hedonic core of mammalian prosociality – and of consummatory pleasure more generally?

Leonard D. Katz

Department of Linguistics and Philosophy, Massachusetts Institute of Technology, Cambridge, MA 02139-4307. lkatz@mit.edu

Abstract: Depue & Morrone-Strupinsky's (D&M-S's) language suggests that, unlike Kent Berridge, they may allow that the activity of a largely sub-cortical system, which is presumably often introspectively and cognitively inaccessible, constitutes affectively felt experience even when so. Such experience would then be phenomenally conscious without being reflexively conscious or cognitively access-conscious, to use distinctions formulated by the philosopher Ned Block.

Depue & Morrone-Strupinsky (D&M-S), in dissecting the personality trait extraversion into independent traits of agency and affiliation, which are in their view based in distinct but interacting core processes and neural systems, also distinguish two different kinds of experience based in these systems. They come close to identifying the affective core of the experience or feeling of social and sexual consummatory reward with the activity of a μ -opioid-receptor-dependent affective process. But they also seem to distinguish from this the "emotional experience" that "is the subjective expression of [affiliative consummatory] reward and physiological quiescence processes" (sect. 5), which quiescence, in their next paragraph (sect. 6), belongs to the experience of reward, as well. Perhaps their implicit view is that, besides cognitively noticed and reportable experience (such as figures in human subjects' "subjective" reports in affective vocabulary), less cognitively accessible inner episodes also are experienced.

The possibility that consciousness conceived of phenomenally, or as it feels, is dissociable from consciousness conceived of in any

cognitive or functional manner, has been more discussed and defended by philosophers (e.g., Block 1995; 1997; 2002) than by the affective scientists, such as Berridge, cited by D&M-S. For Berridge (1999; 2004), it seems that any process science can study, not by self-report but only otherwise, counts as purely objective. But to some philosophers this may seem to run together method or way of knowing with the nature of what we wish thereby to know, and thus to bury substantive questions, such as whether, in the speechless infant or rat whose μ -opioid activity or smile we observe, pleasure is experienced.

Berridge originally distinguished "liking" from more motivational processes by observing the contrasting and recognizably hedonic facial expressions of rats responding to sweet and bitter things. However, he has also argued that, since the same motor responses can also be observed in forebrain-ablated rats and anencephalic human infants, the core affective processes thus expressed are not always felt. Presumably, it is supposed to be intuitively obvious that in such cases there is no one at home. But this may be too cortically or cognitively chauvinistic, if not in these, then in other cognitively unnoticed cases, perhaps including cases of that opioid bliss which is our own. Or perhaps the truth lies somewhere in between, with brain activity that would itself be un-felt, nevertheless sometimes entering essentially (and not only by way of its upstairs effects) into conscious feeling, as seems to be Antonio Damasio's view (1999; 2003).

How largely the affective social warmth that goes with physiological quiescence and behavioral calm in mammals differs from what we experience when basking in the sun – or from what a lizard does when doing the same – remains to be seen. That so much of the archaic structure and function of opioid signaling and response have been conserved suggests that something of felt affect may be conserved as well. Perhaps such conservatism of structure–function linkage is mere accident, a founder effect locked into place in our lineage for only brute historical reasons. But if some opioid functions, affects, and structures are linked by deeper necessities, then such evolutionary conservatism may be more interestingly explained.

To start seeking the general functions and affects that opioid systems may be especially suited to serve, we need not talk to lizards. We can seek to extend D&M-S's synthesis to our own less social and sexual consummations and also consider the human variations found between men and women as well as those presented by autistic brains, which may derive the very same opioid bliss from contemplating things, mathematical structures, or scientific theories as more social brains get mainly from interacting with more fickle friends. Perhaps we will find even more general accounts of what kinds of feeling, function, and structure naturally go together. Then we may be able to tell how much non-socially mediated opioid bliss has in common with the social kind – and perhaps even why things are so.

Is all affiliation the same? Facilitation or complementarity?

Daniel S. Levine

*Department of Psychology, University of Texas at Arlington, Arlington, TX 76019-0528. levine@uta.edu
<http://www.uta.edu/psychology/faculty/levine>*

Abstract: The authors regard opiates as the primary neural substrate for social attachment, and peptide hormones as subsidiary. One may instead conclude from their evidence that oxytocin, vasopressin, and opiates play complementary roles in attachment. Oxytocin and vasopressin relate to different aspects of emotional experience, and opiates to quiescence from long-term attachment. This is related to intimacy versus affiliation.

Depue & Morrone-Strupinsky (D&M-S) are to be commended for making order out of the intricate web of brain areas, neuro-

transmitters, and hormones involved in attachment behaviors. As a neural network modeler, I am a relative newcomer to the attachment and bonding literature, but I have made preliminary suggestions for extending previous conditioning theories to understand social learning in voles and humans (Eisler & Levine 2002; Levine, in press). The target article authors have clearly made a major contribution to such theoretical understanding of attachment.

Yet there is room for fine-tuning the authors' interpretations of behavioral functions for each of the brain regions and biochemical substances. Specifically, considering the groundbreaking and widely appreciated work of Insel, Carter, and others (e.g., Taylor et al. 2000; Windle et al. 2004) on oxytocin and vasopressin in social bonding, the mere "facilitatory" role that D&M-S assign to those peptide hormones is likely to be controversial. This commentary suggests an alternative "spin" on the findings they cite about the roles of oxytocin and vasopressin versus the roles of opiates in attachment behavior.

Before delving into neurochemistry, some psychological distinctions are useful. The authors state (target article, sect. 5) that "the higher-order trait of affiliation is defined by its core underlying processes of affiliative reward, emotional experience, physiological quiescence, and formation of affiliative contextual memories." Evidence from human personality studies leads me to question whether all these different aspects of affiliation should be lumped together. In particular, positive emotional experience and physiological quiescence may be partially separable. The social psychologist Dan McAdams (e.g., McAdams 1982; McAdams et al. 1984) found a need for intimacy that was typically higher in different types of people than the previously discovered need for affiliation (Atkinson et al. 1954). Need for affiliation is characterized by anxiety about being alone, or being left out of social interactions, and an urge to be with other people regardless of emotional closeness. Need for intimacy, by contrast, is characterized by selectivity about social interactions, acceptance of some solitary periods, and enjoyment of close emotional connections with friends.

This suggests that affiliation and intimacy may be dissociable processes in humans. Generically, affiliation (as Atkinson et al. 1954 describe it) seems analogous to D&M-S's physiological quiescence, and intimacy (as McAdams et al. describe it) is analogous to their emotional experience. Does the dissociation of these two processes extend to brain pathways? As the distinction between deep intimacy and superficial affiliation may not be cogent in voles, separation of those functions may require prefrontal cortex. Yet it is also tempting to speculate that intimacy might be more associated with the oxytocin system, whereas simple affiliation is associated with the opiate system. As noted by many researchers the authors cite (e.g., Panksepp 1998; Taylor et al. 2000), the evidence in both humans and other mammals points to oxytocin as being involved in the initiation of social bonds and opiates in the long-term maintenance of these bonds. This suggests that the functions of the oxytocin and opiate systems could be conceived of as being complementary, parallel, and interacting, rather than, as D&M-S propose, that opiates are the primary substrate and oxytocin is "modulatory" or "facilitatory" for the opiate system.

But does this initiation versus maintenance dichotomy square with the dichotomy of intimacy versus simple affiliation posited earlier? The evidence is inconclusive, but this is a strong possibility. Oxytocin has a half-life in the body that is very short, measured in minutes (Uvnäs-Moberg 1998), and then appears to induce long-lasting effects in other systems, particularly the opiate system. This suggests that, in humans, oxytocin could be a substrate for the transitory "peak experiences" coming from intensely positive social interactions, and opiates could do the same for the lasting relationships that these experiences may generate. Also, endogenous opiates have long been known to have analgesic efforts, suggesting that they may be a substrate for the affiliation that relieves the anxiety of loneliness. Yet the complementarity of these two systems is far from perfect. As D&M-S note, there are many

types of opiate receptors, and there is evidence that the opiate receptors involved in social bonding are not the same as those involved in analgesia. Also, oxytocin is involved in reducing stress as well as in inducing pleasure.

Where does vasopressin fit into the picture? There is a well-known gender dimorphism in all mammals studied so far. Oxytocin levels are higher in females and vasopressin in males; oxytocin is associated with maternal tending behavior and vasopressin with paternal protective behavior. Yet this dimorphism may be in degree rather than in kind, for Cho et al. (1999) have shown that pair bonding can be abolished in either male or female prairie voles by drugs that block brain receptors for either of the two peptides. This suggests, again, complementary functions (in both genders) for vasopressin and oxytocin. These functions might be illuminated by looking at which brain regions oxytocin and vasopressin bind to in the pair-bonding prairie vole as compared with the nonbonding montane vole. The key area for oxytocin binding is the nucleus accumbens, part of the dopamine-modulated stimulus-response system. And one key area for vasopressin bonding is the diagonal band, part of the cholinergic forebrain attentional system. Based on these data, Eisler and Levine (2002) proposed that oxytocin is more related to the part of the process that drives behavior via reward, and vasopressin is more related to the part of the process that focuses attention on relevant stimuli – for example, the opposite-sex vole with which the animal is forming a pair bond.

All of these hypotheses, as well as those of the target article and other commentaries, await much further research to be verified. This includes brain imaging and blood chemistry studies in humans engaging in various aspects of affiliative and intimate behavior. And it also includes computational modeling. Existing neural network models of the cortical-subcortical pathways involved in reward learning (e.g., Brown et al. 1999) might be extendable to attachment systems. Such a computational approach, based on dynamical systems, tends to favor theories based on complementary functions (Grossberg 2000).

Affiliative reward and the ontogenetic bonding system

Warren B. Miller

Transnational Family Research Institute, Aptos, CA 95003-4626.
tfraptos@earthlink.net

Abstract: Miller and Rodgers (2001) proposed a central nervous system based Ontogenetic Bonding System that operates across the life course to promote succorant,¹ affiliative, sexual, and nurturant bonds. I discuss features of this theoretical framework that can inform Depue & Morrone-Strupinsky's (D&M-S's) model. Most important, I suggest that the affiliative reward processes D&M-S describe are better conceptualized as subserving the affect/motivation of affection.

I address my commentary to Depue & Morrone-Strupinsky's (D&M-S's) conceptualization of the human trait of affiliation and its role in social bonding. First, let me describe an alternative conceptualization, the ontogenetic bonding system or OBS (Miller & Rodgers 2001). There are three major premises behind the OBS: (1) bonding is a major adaptive strategy among higher vertebrates and is supported by a coordinated set of psychological/behavioral mechanisms; (2) these are governed by a coherent, diffusely distributed, hierarchically organized neural system; and (3) the psychological/behavioral mechanisms and their neural substrate change during growth and development to promote the individual's shifting adaptive needs and goals.

Miller and Rodgers (2001) describe four age-related stages of bonding. The first is the succorant stage of bonding, which is present at birth and serves to bond the child to his or her parent(s) or primary caretaker(s). The second is the affiliative stage of bond-

ing, which emerges during infancy and serves to promote play relationships during childhood, work relationships during adulthood, and friendships generally. The third is the sexual/mating stage of bonding, which emerges around the time of puberty and serves to promote sexual, romantic, and mating relationships. The fourth is the nurturant stage of bonding, which also emerges around puberty, is further stimulated by pregnancy and birth, and serves to bond the parent to his or her child. Although each of these four stages has unique characteristics that serve their own unique tasks, they all share many features that derive from a largely common neural substrate.

At all four stages, the OBS is organized according to the fundamental design plan of the human organism's nervous system. Therefore, the OBS may be described in terms of a sensory input component, a set of five central processing and integration components, and an effector output component. The five central components include attention and arousal, affect and motivation, memory and learning, special and complex cognitive functions such as language and theory of mind, and executive functions that allow integration, planning, and conation. Together the seven OBS components generate schemas, or internal representations, of each person in the social milieu that allow individuals to have feelings about and complex understandings of those persons, store those feelings and understandings for later recall, and integrate those feelings and understandings with other motivations and beliefs.

Affects and motivations are the most central components of bonding schemas because they represent the goals of the organism. In the environment within which humans evolved, these goals were to adapt to the complex physical and social environments encountered in ways that served survival and reproduction. Miller and Rodgers (2001) describe six affects/motivations of importance to bonding schemas: affection, sexuality, fear, anger/aggression, dominance/submission, and loneliness/sadness. These six appear to be based on at least four phylogenetically ancient neural systems. Affection is the "signature" affect/motivation of bonding and is responsible for the positive, warm feelings that inspire a desire for physical and emotional closeness with another person and that make being with that person highly valued. Evidence suggests that both expressing and receiving affection confers survival and reproductive advantages on the individual (Floyd 2002).

With this description of the OBS as background, I have four primary points to make about the target article. (1) The OBS conceptualizes bonding as a life-course phenomenon, one whose content and processes change during development. D&M-S propose a model of affiliative reward that is essentially based on an adult personality trait. I believe that their model would benefit from more incorporation of a developmental perspective. For example, there is the work of Rothbert et al. (1994), who have proposed a developmental model that attempts to link newborn, older infant, and younger child temperamental traits to older child and adult personality traits. (2) The OBS construct assumes that the processes of bonding have appreciable continuity at both the psychological/behavioral and neural levels across the life course, but it also assumes that there are important stage-specific processes that utilize unique neural structures and generate unique affects/motivations at different stages. Thus, at the succorant stage, what Panksepp (1998) has called the panic system interacts with affiliative reward to promote bonding. Similarly, at the sexual/mating and nurturant stages, sexual feelings and altruistic fear, respectively, interact with affiliative reward to promote the types of bonding that are characteristic of those stages. The target article model would be strengthened if these types of interactions were considered in more detail. (3) In the OBS framework, the second or affiliative stage involves bonding to playmates, workmates, and friends. Stage-specific processes for this type of bonding may utilize the play or "ludic" system (Panksepp 1998) and the systems that underlie dominance, submission, and the formation of cooperative alliances. D&M-S argue that their construct of affiliation is a narrower one than those of sociability and social attachment.

From the OBS perspective, their construct is also narrower than that of the affiliative stage bond. In fact, I would argue that what they are describing corresponds to the signature affect/motivation of the OBS, namely affection, or, in trait terms, affectional disposition. This interpretation fits well with their statement that the experience of warmth and affection reflects the capacity to experience rewards elicited by affiliative stimuli. It is noteworthy that although attachment theorists have described several types of affectional bonds (Ainsworth 1991), in Panksepp's (1998) book on affective neuroscience, which includes a number of chapters on the social emotions, the term affection does not even appear in the index. If my argument is correct, then the target article is groundbreaking in its full and detailed discussion of the neural mechanisms underlying affection (and affectional memories). (4) Finally, although affection is the paramount affect/motivation for bonding in the OBS framework, there are others of critical importance to social bonds that should inform the target article model. For example, anxiety/fear systems play a critical role in feeling safe and protected with the bonded other. To paraphrase D&M-S, a satisfying affiliative bond is characterized not just by the presence of warmth and pleasure but also by the absence of fear and anxiety.

NOTE

1. "Succorance" is a term coined by Murray (1938) to describe a general tendency to seek the help and protection of others.

Integrating genetic, behavioral, and psychometric research in conceptualizing human behavioral traits

Marcus R. Munafò

Department of Experimental Psychology, University of Bristol, Bristol BS8 1TN, United Kingdom. marcus.munaf0@bristol.ac.uk
<http://psychology.psy.bris.ac.uk/people/marcusmunaf0.htm>

Abstract: Previous research into human traits has reached impressive consensus regarding at least some traits, but recent evidence suggests these to be genetically heterogeneous. This is problematic for theories of the neurobiology of human traits. Future research should more closely integrate genetic, behavioral, and psychometric research to arrive at biologically validated measurement instruments, which may be better used to understand the mediating role of these traits in the association between genetic variants and complex behaviors.

Research into human personality traits has typically consisted of two broad approaches. In one, psychometric techniques, primarily factor analysis, have been employed to ascertain the structure of personality by inference from a large corpus of responses to individual items, such as "Do you have many friends?" In the other, evidence from animal models has guided the development of theories of personality grounded in the assumption that broad, complex behavioural traits are subserved by distinct neurobiological structures and mechanisms. Examples of the former approach include Costa and McCrae's five-factor model of personality (Costa & McCrae 1997); examples of the latter include Cloninger's tridimensional theory of personality (Cloninger 1986), although there are many others (e.g., Depue & Collins 1999; Eysenck 1990; Zuckerman & Como 1983). The attempt by Depue & Morrone-Strupinsky (D&M-S) to extend the latter approach is a welcome addition to our knowledge regarding the neurobiological basis of behavioural traits.

What might be regarded as one of the triumphs of personality research is the impressive consensus reached by models and theories developed from these two perspectives regarding at least two human personality traits, namely avoidance-related behaviours (variously named neuroticism, harm avoidance, trait anxiety, etc.) and approach-related behaviours (variously named extraversion, novelty seeking, sensation seeking, etc.). To take the example of avoidance- or anxiety-related traits, neuroticism, as described in

the Costa and McCrae taxonomy, and harm avoidance, as described in the Cloninger taxonomy, show impressive form equivalence and have been widely considered to measure the same underlying construct.

This assumption has led to questionnaires derived from different perspectives being used somewhat interchangeably because of the psychometric evidence that they measure the same construct. In particular, studies of the genetic determinants of human personality have tended to use a range of personality questionnaires, including the NEO family of measures (cf. Costa & McCrae 1997) and the Temperament and Character Inventory/Tridimensional Personality Questionnaire (TCI/TPQ) (cf. Cloninger 1986). Recently, however, evidence has emerged that the genetic “signals” provided by these two families of instruments differ, with two recent meta-analyses (Schinka et al. 2004; Sen et al. 2004) reporting a strong association between the serotonin transporter gene and NEO neuroticism, but not TCI/TPQ harm avoidance. We recently conducted a similar meta-analysis (Munafò et al. 2005a) using a more comprehensive ascertainment of the published literature and excluding samples with psychiatric diagnoses and found evidence that in fact TCI/TPQ measures of anxiety-related traits demonstrate a more reliable association with the serotonin transporter gene.

Clearly psychometric equivalence is not sufficient to demonstrate construct equivalence across a range of questionnaire instruments purporting to measure the same behavioural trait. This, then, returns us to the value of developing theories of human personality grounded in the evidence for a neurobiological basis to complex behavioural traits across a range of species. If we are to ascertain the genetic determinants that influence the development of these traits we will be far more likely to be successful if a clear neurobiological pathway is described through which such determinants may exert their influence. This, in turn, will enable far more specific predictions to be made regarding the candidate genes that one might reasonably expect to be associated with these traits.

The delineation by D&M-S of the neurobiological pathways hypothesised to subserve trait affiliation, and in particular the discussion of plausible candidate genes that may govern variation in this trait, is therefore particularly welcome. Some cautionary points are worth considering, however. Most importantly, as much as complex behavioural traits are likely to be under the influence of a number of individual genes, so individual genes will likely influence a range of complex behavioural traits. This genetic pleiotropy will lead to the potential problem of confounding in association studies of personality traits (and other behaviours). For example, the OPRM1 gene identified by D&M-S has been reported to be associated with the cortisol response to opioid blockade (Hernandez-Avila et al. 2003), opioid dependence (Crowley et al. 2003), and response to nicotine replacement therapy among cigarette smokers (Lerman et al. 2004). Interestingly, a recent report suggested no association between variation in this gene and personality traits measured using the NEO Five-Factor Inventory (Hernandez-Avila et al. 2004).

So, given these potential problems, how should the investigation of the genetic antecedents of variability in personality traits proceed? A strong candidate gene is clearly not enough. Serotonergic candidate genes, such as the serotonin transporter, are extremely strong candidates for anxiety-related traits, given the well-established involvement of this neurotransmitter pathway in clinical anxiety and depression, fear response, and so on. Nevertheless, the association between this gene and anxiety-related traits appears to depend, in part at least, on the measurement instrument used. Therefore, in the development of theories regarding previously undescribed behavioural traits, such as affiliation, the identification of plausible candidate genes is only a starting point, albeit a welcome one. Any subsequent development of a psychometric instrument will require close integration with genetic data, for example, to enable the selection of individual questionnaire items on the basis of their association with selected candidate genes. This will afford some degree of biological validation, in parallel with the usual psychometric requirements of a person-

ality questionnaire. Such an approach, however, will require extremely large sample sizes if sufficient power is to be afforded, as effect sizes are likely to be small (Munafò et al. 2003). Following the development of such an instrument, subsequent efforts should include attempts to identify the extent to which behavioural traits mediate the association between specific genes and other complex behaviours. For example, the serotonin transporter gene has been associated with smoking behaviour (Munafò et al. 2004) as well as anxiety-related traits. Since individuals who score highly on anxiety-related traits are more likely to smoke, the association between the serotonin transporter and smoking behaviour may be entirely mediated by this trait. Recent evidence suggests, however, that this is not the case and that the serotonin transporter retains an association with smoking behaviour when trait anxiety is controlled for (Munafò et al. 2005b). This clearly has important implications for the understanding of the mechanisms subserving the complex interrelationships between genetic antecedents of behaviour, behavioural traits, and specific complex behaviours. Future research should integrate genetic, behavioural, and psychometric research in this way if the nature of complex behavioural traits is to be fully understood.

ACKNOWLEDGMENT

Marcus Munafò is supported by a Cancer Research UK Research Fellowship.

Specificity of affiliation supported by neurotransmitter challenge tests and molecular genetics

Petra Netter, Martin Reuter, and Juergen Hennig

Department of Psychology, University of Giessen, D-35394, Giessen Germany. petra.netter@psychol.uni-giessen.de

http://www.diff-giessen.de martin.reuter@psychol.uni-giessen.de juergen.hennig@psychol.uni-giessen.de

Abstract: Support for a neurobiological distinction between affiliation (Attachment) and agency (Achievement) was achieved by comparing responses to a dopaminergic (DA) and a serotonergic (5-HT) challenge test. DA responses were similar, but a 5-HT modulation of DA emerged for Achievement and not for Attachment. Molecular genetics performed on Panksepp's dimension “Care” revealed an association with a polymorphism of the DA catabolizing enzyme COMT that was not associated with separation distress.

The authors of the target article wish to support the idea that the affiliative and the agentic components of extraversion differ from each other on a psychometric as well as on a neurobiological level. It is surprising that they did not refer to the modulation of DA activity by serotonin (5-HT) postulated in their model (Depue & Collins 1999), which was supported by challenge tests serving to characterise personality differences in the first author's previous papers (Depue 1995; Depue & Lenzenweger 2001). Also, the possibility of exploring affiliation by specific DA polymorphisms in humans identified as relevant in approach behavior were not reported. Therefore, some further biological specifications of affiliation may be derived from relating, on the one hand, hormone responses to transmitter challenge tests and, on the other hand, differences in molecular genetics to the trait of affiliation in humans.

In one of our own transmitter challenge studies, 36 healthy male subjects were subjected to a placebo-controlled, balanced crossover design experiment and were divided according to their prolactin (PRL) responses to the DA₂ agonist bromocriptine (1.25 mg) and their cortisol responses to the 5-HT reuptake inhibitor citalopram (30 mg) into high and low responders each (above and below .60 SD placebo-corrected change of hormone responses from baseline, respectively). Furthermore, based on Depue's finding in his first experiment with a bromocriptine challenge (Depue

et al. 1994) that late PRL responses were almost better predictors of high Positive Emotionality than were high responses, the time of response seemed a promising parameter. Therefore, participants were additionally divided into early and late responders (change of hormones before and after 90 minutes from drug application). The personality trait of affiliation was measured by Attachment, a subscale of the Tridimensional Personality Questionnaire (TPQ) by Cloninger et al. (1991) and Social Closeness from Tellegen's Multidimensional Personality Questionnaire (MPQ) (Tellegen 1982). Achievement of the MPQ was applied as the measure best representing the Agency axis in Figure 1 of the target article. By a combined evaluation of time and size of each drug response it emerged that Attachment was associated with either low and early or high and late DA responsiveness, and the same held for Social Closeness (interaction time x size of PRL responses: $p = .001$ and $p = .022$, respectively). Achievement (which correlated almost zero with Attachment, $r = .099$) showed a similar pattern with respect to low and early DA responses, but the interaction did not reach statistical significance (time x size of DA responses: $p = .074$). To specify if the dampening effect of serotonin on the DA system, claimed for the relationship of DA activity with behavior facilitation in general (Depue & Collins 1999), also held when analysed for the component of Affiliation, a combined analysis of size of responses, as well as time of responses to the DA- and the 5-HT challenge, was performed. Interactions between times, but not between sizes, of the DA and 5-HT responses revealed that serotonin was relevant for the Achievement but not for the Attachment component. An early PRL DA response in association with a late cortisol response to the 5-HT challenge was associated with particularly high scores in Achievement (interaction time of DA x time of 5-HT response: $p = .003$), which would support Depue's model (Depue & Collins 1999) of higher agentic DA activity when the serotonergic brake is reduced. However, no relationship between the two systems emerged with respect to Attachment in which DA seems to operate independently of 5-HT. These results indicate that the two components are similar with respect to their DA responsiveness but may be discriminated by their serotonergic modulation of DA. It may sound surprising that time of responses yielded more significant relationships with the personality traits than size of responses. It cannot be ruled out that peripheral metabolic differences are responsible for differences in onset of hormone responses, but this onset may also indicate the inertia or speed of the transmitter systems, no matter if release, uptake, or receptor sensitivity are involved. Therefore, the parameter should be included in further challenge studies of personality differences and has to be elucidated with respect to underlying mechanism by animal studies.

To further corroborate the trait of affiliation, a molecular genetic analysis was performed using data of a validation study of Panksepp's Affective Neuroscience Personality approach (Davis et al. 2003; Panksepp 1998). One of his scales directly assesses affiliation by a dimension called CARE, which was strongly based on animal data and was extended to human behavior. The CARE-dimension is psychometrically and neurobiologically almost identical with Depue & Morrone-Strupinsky's (D&M-S's) concept of affiliation because it also refers to social closeness, nurturance, and affiliative bonding and explains CARE-behavior to be associated with estrogen, prolactin, oxytocin, vasopressin, dopamine, and opioids. Although opioids secreted during activities of social closeness should inhibit the activity of brain regions associated with separation distress, both Panksepp (1998; Panksepp et al. 1980) and D&M-S consider separation distress and affiliation (CARE) to be distinct, but Panksepp also argues that both feelings of separation and care can promote maternal nurturance.

Because D&M-S do not refer to biological data for this assumption and have furthermore only briefly mentioned the molecular genetic impact of the dopaminergic system, a molecular genetic analysis of the Affective Neuroscience Personality Scales (ANPS) was conducted on $N = 233$ healthy subjects. Results demonstrate the salience of genes for the trait "CARE" and support the notion

that dopamine is involved in affiliative behaviour, because the COMT VAL158MET polymorphism of the catechol-O-methyltransferase (COMT) gene was significantly associated with CARE. COMT is the catabolizing enzyme of DA and norepinephrine in the synaptic cleft. A single nucleotide transition in the COMT gene results in a 3- to 4-fold difference in COMT enzyme activity (Lachman et al. 1996) by coding for the synthesis of the amino acid methionine (MET) instead of valine (VAL). Carriers of the MET - allele (genotype VAL/VAL) had significantly higher CARE scores than did carriers of the MET+ allele (VAL/MET and MET/MET) ($F(1, 232) = 4.04, p < .05$). Therefore, highly affiliative behaviour is associated with high enzyme activity of COMT. This by itself only partly predicts brain DA-activity, but it does represent one essential component of it. The absence of an association between the SADNESS-dimension of the ANPS (representing separation distress) supports D&M-S's position that temperamental processes underlying affiliative bonding are not identical with those involved in social separation distress, although these data are not sufficient to negate more subtle functional linkages.

Mesolimbic-mesocortical loops may encode saliency, not just reward

Patricio O'Donnell

Center for Neuropharmacology and Neuroscience, Albany Medical College, Albany, NY 12208. odonnep@mail.amc.edu <http://www.odonnell-lab.net>

Abstract: Depue & Morrone-Strupinsky (D&M-S) present a thorough case for the role of "reward" brain circuits in affiliative bonding. Integration of information in the nucleus accumbens shell (NA), the role of dopamine in this processing, and opioid (primarily via mu receptors) control of these circuits are the primary elements of the model. Although the overall picture is quite compelling, the description leans excessively in the view of dopamine systems as "reward" circuits.

The work of Tom Insel and others over the past several years has unveiled significant amounts of information pointing to a role of reward processes in affiliative bonding. This was done primarily by comparing monogamous prairie voles with the more promiscuous mountain voles (Young et al. 2001). Depue & Morrone-Strupinsky (D&M-S) elaborate on those findings and provide an in-depth description of the reward mechanisms potentially involved. An interesting elaboration is the proposal that formation of affiliative memories is a key element in this process, which may involve neural ensembles in the NA shell. The integration of information that is essential for incentive motivation makes the NA an appealing candidate when one considers reward functions and affiliation. One of the main target areas of the NA, the ventral pallidum is where a large number of vasopressin and oxytocin receptors were discovered in the studies on prairie voles. The accumbens shell, however, is but one of the many stations involved in such processing. Its neighbor, the NA core, and other striatal regions may participate, as well. Basal ganglia circuits have been traditionally viewed as several parallel loops subserving different functions (Alexander & Crutcher 1990). Recent work by Suzanne Haber (Haber et al. 2000) has indicated that there is some lateral transfer of information that may be envisioned as a limbic-to-motor flow in a spiraling mode. Therefore, if dopamine in the NA shell is essential for driving neural ensembles responsible for affiliative memories, as is proposed in the target article, then these ensembles may, in turn, determine the activity of subsequent stations in the circuit (i.e., pallidal, thalamic, and even cortical regions), as well as the activity of the circuits in which the core and other striatal regions participate. For example, a recent imaging study by Semir Zeki (Bartels & Zeki 2004) revealed that what maternal and romantic attachment have in common is the activation of broad striatal areas, the insula and cingulate cortices, as well as the inactivation of prefrontal cortical areas. These results suggest

that the relevant ensembles may imply activation of clusters of activity within entire cortico-basal ganglia-cortical loops. The integration of information in the NA is well characterized, but for global brain functions such as affiliation it may be important to consider the entire circuit (O'Donnell 2003).

The Bartels and Zeki study also revealed that prefrontal cortical areas become inactivated when photos of loved ones are viewed (Bartels & Zeki 2004). The notion of inactivation of areas responsible for behavioral inhibition, such as orbital PFC, is sketchily stated in the model by D&M-S. In an attempt to fit in a "brake" within the model, they propose that the dorsal PFC inhibits the ventral orbital cortex; however, there is no evidence for such interaction. A suppressing role of the orbital/medial PFC (which provides glutamatergic excitatory outputs) in incentive motivation functions may rely not on a direct inhibition of target structures but on more subtle interactions with limbic inputs driving activity in target areas. For example, although limbic inputs facilitate medial PFC responses in NA core neurons (in what was described as a limbic gating of cortical inputs; O'Donnell & Grace 1995), the converse is not true. A strong medial PFC activation reduces the amplitude of subsequent NA responses to hippocampal or amygdala inputs (Goto & O'Donnell 2002). This suggests that limbic inputs can gate neural ensembles in the NA but PFC activity may keep the gate closed. By virtue of these interactions, medial and orbital PFC activity could continuously suppress the acquisition of affiliative memories, and only when this suppression is lifted they could be established.

The mesolimbic/mesocortical systems, linked in the target article to reward mechanisms, are indeed important for incentive-motivation functions by their actions in the NA and PFC. There is currently a debate as to whether dopamine systems are involved in reward or, more generally, saliency of stimuli. Dopamine projections can be activated by reward or expectance of reward (Mirenowicz & Schultz 1996), but they are also activated by aversive stimuli (Horvitz 2000). Furthermore, it has been shown with fMRI that the NA can be activated by anticipation of aversive stimuli (Jensen et al. 2003). Therefore, the classical "reward" systems may actually be encoding saliency. This does not necessarily challenge the target article model, but perhaps it may need to accommodate the role of mesolimbic/mesocortical systems in incentive-motivation as providing a saliency signal. These projections are the spotlight; the content is what happens on stage. Therefore, whether it is rewarding (and therefore likely to support affiliative memories) or aversive (more likely to yield avoidance memory) will depend not on the activation of dopamine pathways but on the state of the system they target.

The extended amygdala and opiates are given a central role in the proposed model. In the case of opiates, it may be difficult to separate them from the consequences of dopamine activation. Mu opioid receptors are known to increase dopamine (DA) cell activity in the ventral tegmental area (VTA). Strong mu activation is proposed to promote a state of pleasant reward and "physiological quiescence." I find the notion of quiescence difficult to envision. As stated, it seems to imply that the brain's goal is to reduce "energy," but imaging studies indicate metabolic activation in brain areas during hedonic experiences (Faurion et al. 1998; Rolls et al. 2003). Pleasant states do not need to be quiescent.

Dopamine-glutamate interactions are discussed as important for the acquisition of contextual ensembles. This is indeed very likely so. Again, the focus is placed on the NA shell, but one should not ignore similar interactions in the core and, perhaps more importantly, in the PFC. DA in the NA has been proposed to decrease background activity, thereby increasing signal-to-noise ratio (and by this, perhaps, indicating saliency). In the PFC, similar interactions exist. One refinement of the proposed model would be that DA-glutamate interactions are more likely to rely on both D1 and NMDA receptors being required for ensemble formation by their cooperativity (Cepeda & Levine 1998; Tseng & O'Donnell 2004) than on evoking each other's release. Another element of the model that may need to include the PFC is the proposed

integration of inputs from the hippocampus, amygdala, and extended amygdala in the VTA as driving contextual binding. Neither the basolateral amygdala nor the hippocampus project directly to the VTA. Although it is known that hippocampal stimulation can activate mesolimbic projections, this action requires an intermediate station, most likely the prefrontal cortex.

Loving opioids in the brain

Jaak Panksepp and Joseph R. Moskal

Falk Center for Molecular Therapeutics, Department of Biomedical Engineering, Northwestern University, Evanston, IL 60201.

jpankse@bgnnet.bgsu.edu j-moskal@northwestern.edu

http://caspar.bgsu.edu/~neuro/Faculty/Faculty_jpanksepp.shtml

Abstract: Brain opioids regulate social emotions in several distinct ways. The abundance of neuroscientific detail in the target article helps familiarize the uninitiated with the true and humbling complexities of mammalian brains, but little of it translates to research strategies, with robust predictions, at the human level. Only global neurochemical affective state variables derived from animal research have clear implications for human research.

The emotional aspects of human personality deserve ever more attention (e.g., Davis et al. 2003). As Depue & Morrone-Strupinsky (D&M-S) elaborate, an optimal strategy for human social neuroscience research is to build on existing animal work on prosocial emotions. Such theoretical bridge building – going from neurochemistry of affiliation in animals to core human psychological functions (e.g., Insel & Young 2001; Panksepp 1998) – requires optimal levels of analysis at both ends of the bridge. D&M-S parse the psychological side nicely, but they fail to sift through the abundant neuroscience evidence as effectively. Why dwell on impressive neuroscientific details that cannot yet be linked to testable psychological issues? We need to attract additional adherents to neuroscientific perspectives rather than mystify psychologists with a deluge of available detail that is not ready for prime-time psychobiological synthesis. We have to learn to walk before we run, and good empirical predictions must bridge between the all too abundant facts and ideas on either side of the brain–mind river. To the extent that neuroscience facts can be crafted into psychobiologically coherent predictions, more neuroscientists will be tempted to pursue such important bridging studies – topics largely ignored until the discovery that oxytocin is important in social processes (Petersen et al. 1992). For various historical reasons, few have been as captivated as D&M-S by the equally compelling opioid hypothesis (Panksepp et al. 1980; 1985).

The authors use the neuroscience details to frame their impressive *correlative* linkage between human affiliative tendencies and inferential measures of brain opioid activity. Although they claim that "processes underlying affiliative bonding are not the same as those involved in social separation distress" (sect. 3.2.2, para. 2), these processes are intimately intertwined, and the summarized results could be a result of subjects feeling discomfort following naltrexone. Also, considering the abundance of opioid systems in the brain, it is premature to put too much explanatory weight on the arcuate nucleus based β -endorphin system. As we all know, many other neurochemical systems beside opioids and oxytocin, are involved, including vasopressin and prolactin (Nelson & Panksepp 1998; Panksepp 1998). And yes, dopamine fuels *all* forms of appetitive behavior, including sexual, maternal, and play desires (Ikemoto & Panksepp 1999), perhaps even passionate love (Bartels & Zeki 2004).

Once we have such general principles, applicable to all mammals, what does the fine neuroscience detail add to our understanding of human affiliation? What additional predictions, which do not already flow straightforwardly from the existing animal data, would D&M-S entertain? Obviously, most detailed neuroscience research can only be conducted in animal models, with

work on motivation- and emotion-specific neuropeptides leading the way to future human trials (Panksepp & Harro 2004). But what are the best animal models?

With the amount of evolutionary diversification that exists, one must select model systems carefully (Panksepp et al. 1992; 2002), and D&M-S wisely prioritized primate data over rodent data. Dogs are also an excellent species (Panksepp et al. 1978). Certainly lab rats are not optimal for understanding separation-distress arising from severing *specific* social bonds. These excellent “test-tube” creatures thrive when housed alone in sterile environments, perhaps because their separation-distress systems are vestigial (Panksepp 2003). *Selective* opioid regulation of social distress is well documented in many species (Panksepp 1998), but is dubious in rats (Winslow & Insel 1991a). Perhaps because of this, they are excellent species for studying the affiliative energies of play and low-dose opioid facilitation of social interactions (Panksepp & Bishop 1981; Panksepp et al. 1985).

As D&M-S recognize, the use of selected neurochemical systems to discuss processes as complex as affiliation needs to be advanced with the proviso that they only approximate the complexity of the underlying causal issues. If we try to extrapolate general neurochemical principles to excessively fine-circuit and synaptic levels, we may be encouraging a radical reductionism that is wrong (Bennett & Hacker 2003). Obviously, social attachments and affiliations are fully “embodied” within brain, body, and environment.

Important fusion points between levels of analysis must not be construed as explanations. But, as this target article exemplifies, meaningful visions of the larger picture cannot deny nor should they shy away from investigations at finer layers of explanation. Continued attempts to stitch neuroscience details from animal studies into coherent, *testable* hypotheses at more molar, human levels are vital intellectual initiatives, as long as we recognize that the emergent neuropsychology of human beings lies at the root of our social dilemmas, not merely the biochemical mechanisms that underlie the electrical properties of subsets of neurons in limited brain regions.

Ultimately, affiliation is an *emergent property* of being a mammal. Attachment does not simply exist in the brain, but in brains’ interrelations with bodies and environments. Analysis of neurochemistries of brain/mind states that correlate in some way with affiliation is a most reasonable empirical way to proceed, especially if we carefully strip away erroneous philosophical assumptions, as well as potentially irrelevant fine details. If we do that well, translations between levels can be advanced at a more rapid pace than was evident during the 20th century. Evidence for brain opioids in the regulation of social affect has been definitive for a while (Panksepp et al. 1980), and connections to human brain imaging are impressive (Zubieta et al. 2003).

Attempts to link such animal work to human concerns are essential for progress on major societal problems. For example, opiate addiction may often reflect the desire of individuals to diminish depression and chronic mental distress – to feel socially whole again (Panksepp 1981). We already have safe medications, such as the mixed opioid agonist-antagonist buprenorphine, invaluable in narcotic detoxification, which could be used to study and to treat such emotional imbalances clinically (Bodkin et al. 1995). There is a linkage between opioids and affiliative tendencies in all mammals. New approaches at the human level (e.g., Davis et al. 2003; Panksepp & Harro 2004), as exemplified by the contribution by D&M-S, are needed to round out this “too hot to handle”¹ scientific saga. However, as more and more investigators try their hand at such bridge building, it is important to cultivate the most appropriate level of analysis, and to recognize that even velvet-gloved reductionism needs to affirm emergent, holistic models that do no injustice to complex, sociobiological phenomena.

NOTE

1. When first submitted as an empirically based hypothesis for publication in the mid 1970s, our seminal brain-opioid mediation of social affect data were rejected for publication despite two positive reviews. The

then managing editor of *Science* advised JP by phone of his reason for not publishing – the hypothesis needed to be extensively replicated because otherwise it was “too hot to handle.” As of a month ago, that is no longer the case (Moles et al. 2004).

Impaired hedonic capacity in major depressive disorder: Impact on affiliative behaviors

Diego A. Pizzagalli and Christen M. Deveney

Department of Psychology, Harvard University, Cambridge, MA 02138.

dap@wjh.harvard.edu deveney@wjh.harvard.edu

<http://www.wjh.harvard.edu/~daplab/>

Abstract: Research on the neurobiology and psychosocial features of Major Depressive Disorder has the ability to extend our understanding of affiliative behavior. In depression, decreased hedonic capacity and hypoactivity in dopaminergic and prefrontal circuitries may decrease the ability to experience affiliative relationships as rewarding. We suggest that neurobiological research on depression can provide a test case for theoretical models of affiliation.

The target article provides a comprehensive description of trait affiliation and commendably integrates a broad series of literatures including animal, neurobiological, personality, and psychosocial. Depue & Morrone-Strupinsky (D&M-S) argue that the ability to experience affiliative reward is essential to the development and maintenance of affiliative bonds. Literature in which the reward capacity of an organism is manipulated is used to highlight the relationship among decreased reward capacity, decreased incentive motivated behavior, and decreased reward from affiliative interactions. However, as the authors note, much of the model is based on animal data. In this commentary, we suggest that Major Depressive Disorder (MDD) provides a fruitful extension of this model of affiliative behavior because this population constitutes a naturally occurring group of individuals with decreased capacity to experience pleasure (anhedonia), a cardinal symptom and trait marker of vulnerability to MDD (American Psychiatric Association 1994; Meehl 1975). Specifically, we comment on neurobiological correlates of anhedonia in MDD and the interpersonal deficits exhibited by this population. Finally, we discuss specific affiliative relationships between infants and depressed mothers, “the prototypic affiliative bonding condition” (target article, sect. 4.1). Research on such naturally occurring populations of decreased reward capacity has the potential to provide converging evidence for and extension of this model of affiliation through the development of testable hypotheses.

Several lines of evidence point to a decreased hedonic capacity in MDD. First, MDD has been associated with decreased responsiveness to positive cues (Sloan et al. 2001) and reward (Henriques & Davidson 2000; Hughes et al. 1985), as well as with dopaminergic hypoactivity, the neurotransmitter most implicated in reward (Wise & Rombre 1989). Individuals with MDD exhibited abnormal response to a dopaminergic probe (Tremblay et al. 2002), increased striatal binding of the D2 antagonist IBZM (Shah et al. 1997), and increased dopamine transporter (Laasonen-Balk et al. 1999), putative markers of down-regulated dopamine activity. Second, the distributed neural network reviewed in the target article, governing hedonic processing, formation of affiliative memories, and the emergence of appetitive behavior, is dysfunctional in MDD (Davidson et al. 2002). Whereas abnormalities in the amygdala and hippocampus may lead to dysfunctions in stimulus-reward association and contextual learning for affiliative stimuli, respectively, dysfunctions within different prefrontal cortical (PFC) regions may underlie difficulty in anticipating, evaluating, and experiencing reward in MDD. The subgenual PFC, in particular, has been implicated in reward responsivity because of its rich innervation with dopamine from the ventral tegmental area (Gaspar et al.

1989). Notably, individuals with MDD exhibit hypoactivity in the subgenual PFC (Drevets et al. 1997), and one study related this hypoactivity to melancholic depression, a subtype of MDD characterized by anhedonia (Pizzagalli et al. 2004). A second PFC region implicated in reward processing is the orbitofrontal cortex (OFC), which is critically involved in reinforcer evaluation and learning of stimulus-incentive associations. Interestingly, decreased medial OFC volume and decreased glial and neuron density have been reported in MDD (Bremner et al. 2002; Lacerda et al. 2004; Rajkowska et al. 1999). OFC dysfunction may be a marker for vulnerability to MDD because it is present in response to sad mood provocation in currently depressed and remitted individuals as well as in those individuals who later relapsed (Bremner et al. 1997; Liotti et al. 2002). Considered within the model presented in the target article, these findings suggest that the disruption in affiliative reward capacity and memory formation should lead to affiliative behavior difficulties in individuals with MDD.

Indeed, research suggests that individuals with MDD exhibit decreased attention to positive facial expressions, decreased social competency scores, impaired social problem-solving skills, and fewer positive interactions in intimate relationships (Fisher-Beckfield & McFall 1982; Gotlib & Asarnow 1979; Lewinsohn et al. 1980; Suslow et al. 2001; Zlotnick et al. 2000). Early theories of MDD considered low rates of response-contingent positive reinforcement to play a central role in the causation and perpetuation of depression (Lewinsohn 1974). However, the precise ties between interpersonal deficits and the ability to experience affiliative reward remain largely uninvestigated.

Growing evidence indicating impaired affiliative relationships between depressed mothers and their infants (Field 1995) provides further insight regarding trait affiliation. Depressed mothers demonstrate less physical and eye contact with their infants, display more negative and fewer positive facial expressions, exhibit less positive affect, use fewer positive affiliative behaviors, exhibit more behaviors unrelated to an infant's actions, and spend less time talking with their infants than do non-depressed mothers (Field 1995; Field et al. 1990).

Infants of depressed mothers also exhibit reward-related behavioral and neurobiological abnormalities when compared to infants of non-depressed mothers. For example, they demonstrate more negative and fewer positive facial expressions, fewer vocalizations, less positive affect, and more withdrawal behavior than do the offspring of non-depressed mothers (Field 1995). They also exhibit lower urinary dopamine levels than infants of control mothers (Diego et al. 2004). Moreover, general PFC hypoactivity and EEG asymmetry patterns similar to those in adult clinical populations have been observed among infants of depressed mothers (Dawson et al. 1997a; 1997b; 1999; 2003). Decreased left PFC activity was associated with decreased engagement and contingent responding, less approach behavior, and less affection by the infant (Dawson et al. 1999).

This unique literature is consistent with the idea that impaired reward capacity among mothers with depression may lead to abnormal affiliative interactions with their children and possibly reward-related neurobiological abnormalities in the offspring. Because important affiliative bonds are established between mother and infant within the first few days following birth (see sect. 7.3 of the target article), examining populations in which the mother's capacity to experience pleasure is reduced, as may occur during postpartum MDD, and the subsequent effect on mother-infant relationships could provide critical insight into mechanisms subserving affiliative relationships, including why individuals may experience different levels of affiliative reward capacity. In particular, the pattern of neurobiological abnormalities and the corresponding affiliative behaviors exhibited by individuals with MDD may identify potential "sources of individual differences that occur within the functioning of the network of neural structures and variables associated with the trait" (target article, sect. 7), thereby addressing a major challenge to neurobehavioral models of affiliation.

ACKNOWLEDGMENT

Preparation of this article was partially supported by NIMH Research Grant R01MH68376 to Diego A. Pizzagalli.

Is the construct for human affiliation too narrow?

Nancy Nyquist Potter

Department of Philosophy, University of Louisville, Louisville, KY 40292.
Nancy.Potter@louisville.edu

Abstract: The construct for affiliation in Depue & Morrone-Strupinsky's (D&M-S's) study is restricted to the interpersonal domain. This restriction is not found in other disciplines. It may be necessary in early stages of trait research. But the construct will need to be expanded to speak to the more complex, second-order affiliations of which humans are capable.

The science of affiliation makes significant and exciting headway in this target article. Love, affection, and attachment have been shown to be crucial to the well-being and survival of individuals and groups in the animal kingdom (Cassidy & Shaver 1999; Harlow 1958; Harlow & Zimmerman 1996; Karen 1994), but until now a substantive model has not been presented that explains, from a neurobiological perspective, how affiliation as a personality trait develops.

Depue & Morrone-Strupinsky (D&M-S) rightly observe that an analysis of the construct of affiliation is crucial to their study, because how affiliation is understood determines which direction researchers will take in positing and studying core processes (sect. 1). They state that "affiliation is clearly interpersonal in nature" (sect. 2) and define affiliation as "enjoying and valuing close interpersonal bonds and being warm and affectionate" (sect. 2). Within the parameters of this construct, the model has much to offer. The scope, though, may be too narrow to explain much of human social behavior.

As the authors say, core behavioral-motivational processes promote not only parent-infant bonds and mate pairs but, "more generally," bonds "between individuals to promote formation of social groups that are necessary for tasks critical to survival" (sect. 4, para. 1). They state that "activation of the underlying processes leads in varying degrees to behaviors associated with *intimate social engagement*" (sect. 5, emphasis in original). In the context of the authors' definition of affiliation, one can understand intimacy as a relation between individuals, families, and loved ones. But intimate social engagement for humans is not only, or necessarily, directly interpersonal, and objects of affiliation are not just other humans. As the etymology of the word indicates, "affiliation" comes from the Latin language and refers to adoption. Other disciplines use the term "affiliation" to apply to a broad range of entities. People affiliate with (adopt) religious values and moral norms (cf. Taris & Semin 1997). People affiliate with sports teams even though they don't know the players personally. Depending on a group's cosmology, members may affiliate with rocks and trees, as many First Nations people do, believing rocks and trees to have spirits just as humans do. We affiliate with (adopt) bodies of knowledge. Consider Western science's affiliation with the medical model and traditional cultures' affiliation with healers, rituals, and folk medicine. And we affiliate with ideologies and ideals. It would probably mischaracterize some of these affiliations to say they evoke warmth and affection as interpersonal relationships can, but nearly all the things humans affiliate with include strong positive bonding emotions. Applying the construct of affiliation to the political level, one notices that an incentive-encoded affiliative memory network would be abstract and symbolic, as the bonding network would include not only individuals and groups but also ideas such as freedom, equality, and rights. People become committed to these abstract ideals, they bond with them, and they work to protect them. They become passionate

about them. Such a capacity for second-order affiliative bonding is also part of the survival skills of evolving humankind. Does D&S-M's model have the capacity to explain neural binding when the affiliations are more complex?

For example, the first level of the Affiliation Trait Model (affiliative stimuli) may need to be expanded. The authors propose auditory, visual, tactile, olfactory, and multimodal stimuli, but the latter is identified as "emotional distress of another." It is difficult to see how religious affiliation, where the primary bond is between a human and a god who cannot be experienced as sensory stimuli (at least not in standard scientific terms of the senses), would be explainable. Yet it won't do simply to bracket off the kinds of affiliation that are symbolic and intangible. Affiliation is part of a fundamental behavioral system that "evolved to promote alliances with others" (sect. 3.2), and intellectual, spiritual, and ideological affiliations promote alliances just as much as interpersonal relationships do.

Considering the model from the perspective of reward raises similar questions about its scope. The authors posit that the key element in the capacity for affiliative bonding is the capacity to experience reward from affiliative stimuli (sect. 3.1). Their argument is persuasive. But humans experience reward from a wide range of affiliative activities unavailable to animals, from playing with dolls to praying. In summary, human affiliative bonding is more complex than a construct that limits affiliative bonding to interpersonal bonding suggests. And this point, in turn, suggests that the "animal bridge" may be weak.

Finally, people also affiliate with ethnic groups (Garcia 2001). Whereas affiliation may be a personality trait that emerged because it promoted an evolutionary advantage, it also is frequently part of identity formation. Here, affiliation is not only a "bonding with" but a "bonding against." Franz Fanon, for example, argued that Negro identity is shaped by the sense that one is a negation: not-White (Fanon 1982); historically, White people affiliated with one another while simultaneously disaffiliating, or bonding together against, Black people. Bat Ami Bar-On describes learning what it meant to be an Israeli in part by distinguishing herself from rival Arabs; her bonding was both with Israelis and against Arabs (Bar-On 1994). Affiliation and social engagement are soothing and stabilizing, as the authors note (sect. 6.1.3), but it is important not to lose sight of the costs of affiliation. The larger social contexts of nationalism, fundamentalism, and identity formation suggest that affiliative bonding can be deadly for others.

So how much does D&S-M's study tell us about the trait structure of affiliation in personality? Quite a bit, even if the construct of affiliation is confined to interpersonal relationships. Personality theory relies on conceptual elucidation and empirical research of traits, and D&S-M have provided a rich foundation on which to build. The study of personality disorders will also receive a boost from the theory and science in this study. Difficulties in affiliation are recognized as central to many personality disorders, and research into affiliation using this model should benefit our understanding of them. For example, the authors suggest that separation distress may be neurobiologically driven, the roots of which are an evolutionary drive to reverse social isolation (sect. 3.2.3). This idea is relevant to those with Borderline Personality Disorder, who fear abandonment and may become desperately clinging and needy. Those with Antisocial Personality Disorder, who exhibit superficiality and exploitative behavior when it comes to interpersonal relationships, may be better understood in terms of levels of μ -opiates. And people with Narcissistic Personality Disorder, who lack empathy and are self-absorbed, may be understood as having a neurobiologically based dysfunction that deforms the affiliative processes.

Endogenous and exogenous opiates modulate the development of parent–infant attachment

James Edward Swain, Linda C. Mayes, and James F. Leckman

Child Study Center, Yale University School of Medicine, New Haven, CT 06520. james.swain@yale.edu linda.mayes@yale.edu james.leckman@yale.edu

Abstract: In addition to endogenously produced opiates, which are part of normal affiliative neurocircuitry and attachment formation, exogenous opiates – such as drugs of addiction and abuse – may affect affiliation. We consider possible modulatory effects of such exogenous opiates on the development of early parent–infant attachment from both parents' and infants' perspectives.

The development of parent–infant attachment (PIA) is a special case of affiliative bonding. The formation and maintenance of affiliative bonds between parent and infant depend on several key neural circuits and involve dopamine, oxytocin, and endogenous opiates (Numan & Sheehan 1997). The appropriate involvement of endogenous opiates in the potentiation of contextually relevant stimulus-provoked dopamine signaling in the ventral tegmental area and the nucleus accumbens shell is reviewed by Depue & Morrone-Strupinsky (D&M-S). There may be critical involvement of two other systems: ascending dopaminergic systems associated with reward pathways (Koob & Le Moal 1997) appear to play a crucial role in facilitating maternal behavior, and oxytocin also appears to play an especially important role in facilitating the onset, rather than the maintenance, of maternal attachment to pups (Insel 1997). For example, pup retrieval and assuming a nursing posture over pups were blocked in parturient dams by infusions of an oxytocin antagonist into the ventral tegmental area or medial preoptic area (Pedersen et al. 1994). Therefore, the initiation and maintenance of parental behavior with pregnancy and transition to parenthood depend on particular structural and molecular changes in well-conserved limbic, hypothalamic, and midbrain circuits. Furthermore, at least nine genes have been identified as necessary for the expression of maternal behavior (Leckman & Herman 2002). Recent human neuroimaging studies have begun to delineate the circuitry that is critical for PIA (Barels & Zeki 2004; Lorberbaum et al. 2002; Nitschke et al. 2004; Ranote et al. 2004; Seifritz et al. 2003; Swain et al. 2004). In these studies, more activity was measured in medial prefrontal, orbitofrontal, and cingulate cortices, thalamus, midbrain, hypothalamus, and striatum in response to infant stimuli versus control conditions. Investigating the mechanisms by which drugs of abuse co-opt reward and endogenous opiate systems and dysregulate the neural circuitry involved in parenting may elucidate the complex interactions among opiate and dopaminergic systems, genes, and the environment in the regulation of parental affiliation (Leckman & Mayes 1998; Leckman et al. 2004).

Exogenous opioids are well known to impair maternal behavior in both clinical and preclinical models (Blass et al. 1995; Bridges & Grimm 1982; Mayer et al. 1985; Stafisso-Sandoz et al. 1998; Wellman et al. 1997). Mayer and colleagues (1985) reported that daily morphine administration beginning on day 9 of pregnancy decreases placentophagia and maternal cleaning pups of umbilical cord and birth fluids. Additionally, Bridges and Grimm (1982) reported that morphine administration after surgical removal of the pups on day 17 of pregnancy delayed the onset of maternal behavior. This effect was blocked by a concurrent administration of an opiate antagonist. Administration of morphine into the medial preoptic area of rats blocks maternal behavior (Mann et al. 1991). Further, Kinsley et al. (1995) reported maternal aversion to the odor of pups after intracerebroventricular injection of morphine, reversible with naloxone. Perhaps morphine not only impairs maternal behavior but also accentuates other behaviors that interfere with maternal capacities. This is supported by Slamberova et al.

(2001), who found that repeated morphine administration during the second half of pregnancy decreases active maternal behaviors (including nursing, presence in the nest, pup contact, pup grooming, and timely retrieval of all pups into the nest), while increasing non-maternal behaviors (including self-grooming, resting with eyes closed, and stereotyped rearing and sniffing).

At least one explanation for the impact of exogenous opiates on parental care may reflect the similarity between the activation of attachment systems and drug addiction, particularly to opiates (Panksepp et al. 1994). Based on this idea, as detailed by D&M-S, several researchers have suggested that endogenous opiates mediate the rewarding properties of affiliation, and a reduction in endogenous opiates increases the need to activate the attachment system and seek proximity with attachment objects (see also Panksepp 1981). According to this model, exogenous opiates should reduce the need to seek and maintain proximity to attachment objects, and this hypothesis has been supported in both primate and nonprimate models (Nelson & Panksepp 1998). Thus, exogenous opiates may directly commandeer parental motivation to seek out and care for family members. For example, in the non-human primate, administration of morphine significantly reduces the amount of grooming time and grooming solicitations among adults (Keverne et al. 1989). In mother–infant separation and reunion of rhesus macaques, exogenous morphine significantly reduced clinging with the infant in the first half hour of reunion, whereas naltrexone increased the clinging behavior between mother and infant (Kalin et al. 1995), presumably by blocking endogenous opiates and thus increasing the drive for proximity and attachment related behaviors. Further, following opiate withdrawal, rats showed long-lasting decrements in learning and motivation to acquire appetitive reinforcement (Harris & Aston-Jones 2003). It seems plausible that opiate withdrawal problems would manifest in human PIA.

Also relevant to the human model is the possible impact of exogenous opiates on developing infant brain and behavior. Infant exposure to exogenous opiates conceivably disrupts PIA either by altering responsiveness to parental cues or by altering the ability to appropriately signal for care (Swain et al., in press). For example, μ -opioid-receptor knockout mouse pups emitted fewer ultrasonic vocalizations on separation from their mothers (Moles et al. 2004), though there is no work yet on the impact of prenatal exogenous opiate exposure on pup behavior. In humans, infants exposed to opiates in utero may experience postpartum withdrawal with the attendant neurobehavioral effects (Barr & Jones 1994) that may make it even more difficult for an opiate-addicted mother, who may herself have impaired parental function, to care for the infant. Also relevant is the intergenerational impact of maternal opiate use. It is well documented that the risk for substance abuse is increased in the offspring of substance-using parents, though the mechanisms are probably multiple. In addition to genetic factors and long-term effects on stress regulatory capacities in the offspring (Vathy 2002), it is possible that manifold mental health problems are transmitted nongenomically through dysregulated parenting.

Converging evidence suggests that parental opiate use may hijack reward neurocircuitry that is crucial for parent–infant attachment and long-term health.

Deficits in affiliative reward: An endophenotype for psychiatric disorders?

Alfonso Troisi^a and Francesca R. D'Amato^b

^aDepartment of Neuroscience, University of Rome Tor Vergata, Rome, 00161, Italy; ^bSection of Psychobiology and Psychopharmacology, Institute of Neuroscience, National Council of Research, Rome, 00137, Italy.
alfonso.troisi@uniroma2.it f.damato@ipsifar.rm.cnr.it

Abstract: Depue & Morrone-Strupinsky's (D&M-S's) model of affiliation meets the criteria advanced for the definition of behavior systems and endophenotypes. We argue that its application in psychiatry could be useful for identifying a biological pathophysiology common to a variety of conditions that are currently classified in very different categories of psychiatric nosography, including autism, schizoid personality, primary psychopathy, and dismissing attachment.

In discussing their novel neurobehavioral model of affiliative bonding, Depue & Morrone-Strupinsky (D&M-S) focus on individual differences in the capacity to experience affiliative reward via μ -opioid postsynaptic receptor activation and its modulators (dopamine, oxytocin, vasopressin, and gonadal steroids). Within certain limits, the existence of such individual differences is likely to reflect normal variation. However, the lower extreme of the distribution in the capacity to experience affiliative reward could represent an endophenotype for psychiatric disorders. Endophenotypes, defined as measurable components unseen by the unaided eye along the pathway between disease and distal genotype, have emerged as an important concept in the study of complex neuropsychiatric diseases (Gottesman & Gould 2003).

Most studies investigating pathological abnormalities in affiliative reward have focused on infantile autism or disorders of the schizophrenia spectrum. In spite of conflicting findings, the opioid-excess hypothesis of autism has attracted considerable interest (Sher 1997), and a dysfunction of the D2 dopamine receptors leading to a reward deficiency syndrome has been implicated in schizoid personality (Blum et al. 2000). However, both autism and schizoid personality involve not only a marked reduction in the desire to engage others socially but also high levels of social disability. In addition, the complexity of the clinical picture of these disorders, which may include concomitant cognitive, psychotic, and obsessive symptoms, makes it difficult to test the hypothesis of a selective impairment of the capacity to experience affiliative reward. We suggest that research aimed at exploring pathological abnormalities in affiliative reward should enlarge its scope to include behavioral syndromes in which a deficit in affiliation-elicited reward is associated with normal social skills (such as primary psychopathy and dismissing attachment) and neuropsychiatric disorders characterized by unusual levels of hypersociability (such as Williams syndrome; Doyle et al. 2004). Here we limit our discussion to primary psychopathy and dismissing attachment.

Primary psychopathy is a pervasive pattern of disregard for the rights of others, and is associated with distinctive emotional and behavioral features. Individuals with this personality disorder are frequently deceitful and manipulative in order to gain personal profit. Even though they may display a glib, superficial charm, these subjects lack empathy and tend to be callous, cynical, and contemptuous of the feelings, rights, and suffering of others. Finally, they display a reckless disregard for their personal safety and are free of symptoms of anxiety (Skeem et al. 2003). Clinicians agree that the core psychopathological feature of primary psychopathy is the incapacity to experience warmth and affection in the absence of any other deficit of social cognition (Herpertz & Sass 2000). Persons with this disorder are capable of accurately assessing the costs and benefits of short-term social interactions, accurately reading others' behavior rules, utilizing self-monitoring information to alter their strategies, and successfully disguising their intentions. Therefore, their deficit in affiliation-elicited reward is not associated with poor social skills or low levels of sociability, as it is case in autism and schizophrenia spectrum disorders. Although there are no data on the brain opioid activity in primary

psychopathy, it is interesting to note that, compared to control subjects, persons with this disorder show less physiological arousal in response to threats of pain or punishment and more tolerance of actual pain or punishment (Veit et al. 2002). There are also preliminary data showing an association between antisocial personality and the A1 allele of the DRD2 gene, a polymorphism linked to dopaminergic deficiency and reward deficiency syndrome (Ponce et al. 2003).

Unlike primary psychopathy, dismissing attachment is not a psychiatric disorder. Rather, dismissing attachment is best conceptualized as a personality trait that can or cannot be associated with a variety of psychiatric disorders, including antisocial psychopathic personality. Dismissing individuals are described by themselves and their friends as somewhat indifferent, cold, and emotionally inexpressive. These qualities are illustrated by Bartholomew's theoretical description of dismissing attachment, typically used in self-report measures of adult attachment style: "I am comfortable without close emotional relationships. It is very important to me to feel independent and self-sufficient, and I prefer not to depend on others or have others depend on me" (Bartholomew & Horowitz 1991, p. 224). In a study aimed at analyzing the relationship between dismissing attachment and sexual intimacy, dismissing individuals were found to avoid intimate behaviors such as holding hands, mutual gazing, cuddling, and kissing (Fraley et al. 1998). Interestingly, dismissing individuals engaged in sexual activities with their partners just as frequently as did nondismissing subjects. Thus, dismissing individuals do not avoid sexual activity per se, but they do avoid the kind of intimacy that, within romantic relationships, most people experience as rewarding and that might facilitate emotional bonding, such as cuddling and expressing affection. Unlike individuals with primary psychopathy, dismissing individuals are likely to be a heterogeneous population comprising persons who are truly indifferent to affiliative reward and others who defensively suppress emotions and behaviors that facilitate attachment formation to prevent separation distress (Fraley et al. 1998). Neurobiological studies inspired by the D&M-S model could distinguish between the two subgroups.

Arguing for the application of a Darwinian approach to the study of mental disorders, McGuire and Troisi (1998) have emphasized the necessity to revise the classification of psychiatric disorders using evolved behavior systems as the building blocks for the construction of more valid nosological categories. D&M-S's model of affiliation meets both the criteria advanced by McGuire and Troisi (1998) for the definition of behavior systems and those proposed by Gottesman and Gould (2003) for the definition of endophenotypes. Its application to the study of psychiatric disorders could be useful for identifying a biological pathophysiology common to a variety of conditions that are currently classified in very different categories of psychiatric nosography. In addition, the neurobehavioral model of affiliative bonding is likely to facilitate the integration of ethological data on experimentally-induced alterations of brain opioid activity in animal models (Moles et al. 2004; Schino & Troisi 1992) with human studies focusing on the genetic and neurobiological correlates of different forms of social attachment (Bartels & Zeki 2004; Insel & Young 2001).

A nonhuman primate perspective on affiliation

Tamara A. R. Weinstein and John P. Capitanio

California National Primate Research Center, University of California, Davis, CA 95616. tweinstein@ucdavis.edu jpcapitanio@ucdavis.edu

Abstract: Primate research suggests that affiliation is a highly complex construct. Studies of primate affiliation demonstrate the need to distinguish between various affiliative behaviors, consider relationships as emergent properties of these behaviors, define affiliation in the context of general environmental responsiveness, and address developmental changes in affiliation across the lifespan.

Depue & Morrone-Strupinsky (D&M-S) have written a masterful review of what is known about the neurobiological underpinnings of affiliation and related processes. As the authors indicate in section 9, however, a substantial disconnect exists between the phenomenon to be explained – affiliation in humans – and the available database – studies of maternal and sexual behavior in rodents. The goal of our commentary is to raise some issues based on non-human primate data regarding the construct of "affiliation," and to add information from that literature that complements the authors' review.

Affiliation is not the same as a preference, relationship, or bond. An individual may possess an affiliative *disposition* while alone on a desert island, but have little opportunity to express affiliative *behaviors*. In addition, *preferences*, *relationships*, or *bonds* imply the involvement (or, at a minimum, tolerance) of a second individual, and, for relationships at least, some degree of longevity. Relationships also have emergent characteristics (e.g., symmetry) that are a product of, but separate from, the individuals' dispositions. Affiliation thus comprises phenomena at multiple levels of analysis including physiological and psychological systems, whole individuals, short-term interactions between individuals, longer-term relationships, and groups (Hinde 1992). Each level necessitates its own descriptive and explanatory concepts, and neurobiological influences become considerably less distinct and direct as levels increase (Feibleman 1954).

Behavioral manifestations of affiliation may not be equivalent. In nonhuman primates, affiliation is inferred from diverse behaviors such as proximity, grooming, physical contact, and play, which develop at varying rates, are differentially prevalent in different types of relationships, and are differentially displayed by males and females (Colvin & Tissier 1985; Cooper & Bernstein 2000; Hayaki 1983; Nakamichi 1989). Moreover, administration of opiate receptor agonists (morphine) or antagonists (naltrexone) does not affect all affiliative behaviors in the same way. For example, Schino and Troisi (1992) found that naltrexone administration to juvenile long-tailed macaques increased their initiations of proximity to their mothers and the number of grooming solicitations displayed, but it did not change the duration of proximity and passive contact and caused a nonsignificant decrease in play. Morphine administration in common marmosets selectively increased the frequency and duration of social play but had no effect on physical contact or allogrooming (Guard et al. 2002). This suggests that the neurobiological underpinnings of various affiliative behaviors may be more different than the authors imply, supporting the idea that these behaviors should be considered as separate, though related, components of affiliation, and highlighting the need to record multiple behavioral measures in any study of the neurobiology of affiliation.

The relationship between affiliation and responsiveness in general is not clear. On the one hand, early studies of social isolation rearing in macaques suggest a link, in that animals so reared demonstrate an unwillingness to engage both the social and the inanimate environment (see review by Capitanio 1986). Other studies of primate early experience also suggest that social interest may be tied to a more active and generalized style of response. For example, compared to monkeys reared with inanimate surro-

gates, monkeys reared with either a mobile surrogate (Eastman & Mason 1975; Mason & Berkson 1975) or a mongrel dog (Capitanio 1984; 1985; Mason 1978; Mason et al. 1991) showed more social interest, including looking at social stimuli, interacting with conspecifics, and interacting in more complex groupings; they also showed greater overall responsiveness, such as willingness to enter a novel area, greater activity and problem-solving ability, and physiological responsiveness. On the other hand, other evidence suggests that there is no clear relationship between affiliation and generalized stimulation seeking, and that the “social” aspects of affiliation may be distinct from more general appetitive and consummatory processes. For example, although some studies of human personality have found sensation seeking to be moderately positively correlated with extraversion (with correlations ranging from 0.20 to 0.50; see Aluja et al. 2003), more detailed analysis has revealed that facets of extraversion particular to affiliation – warmth and gregariousness – have no correlation with sensation seeking (Aluja et al. 2003). This raises the question of whether “social stimuli” are akin to other “classes of stimuli” that activate incentive motivation, or whether social objects and the motivational processes associated with them are fundamentally different from the processes associated with nonsocial stimuli.

Mating behavior and maternal care are not the same as affiliation. Both of these behaviors have probably been acted on strongly by natural selection, which has found many ways of ensuring their presence in a species. Affiliation is one way, but there are others. Mating behavior in orangutans, for example, frequently involves forced copulation by males amid vigorous protests by females (Mitani 1985). Maternal care in the monogamous titi monkey is weak, consisting mainly of nursing. In fact, leaving the infant and mother alone together typically results in agitated behavior on the part of the mother (Hoffman et al. 1995). Neither of these examples suggests “affiliation.” Moreover, the interactions between mothers and pups of most rodent species do not suggest anything more than a caregiving relationship. There is little evidence that mothers recognize individual pups; behaviors directed toward pups are more characteristic of focused reactions to ensure survival rather than of an interactive experience of social enjoyment or warmth, and the relationship between mothers and pups is usually very short-lived, ending abruptly when pups are fully weaned.

Furthermore, the affiliative relationships that contribute to social cohesion in many primate societies (including human societies) are neither caregiving nor sexual (Cooper & Bernstein 2000; Dunbar 1991; Nakamichi & Shizawa 2003). These relationships, sometimes called “friendships,” are long-term, are often established early in life (Berman 1982; de Waal, 1996), and may confer benefits to the interactants such as access to resources (Manson 1994), or may confer no benefit other than the apparent pleasure of companionship (Cooper & Bernstein 2000; Matheson & Bernstein 2000). We contend that these relationships and their associated behaviors are better examples of affiliation than mother–infant or sexual relationships, which often lack the complexity, longevity, and specificity characteristic of friendship bonds.

Affiliation develops. The earliest major behavioral change that a nonhuman primate undergoes during the course of development is a decrease in the amount of time spent with mother and an increase in time spent affiliating (particularly playing) with peers (Hinde & Spencer-Booth 1967; Nakamichi 1989). One of the most prominent changes in the affiliative behavior of nonhuman primates as an individual approaches sexual maturity is the decrease in frequency and duration of play beginning in late infancy or early juvenility, and resulting in little or no play during adulthood (Fagen 1993). Another important developmental change is increasing selectivity of individual preferences for affiliative partners. Kojima (1998) showed that Japanese macaque infants initially interact with a large number of different animals, but as they approach one year of age they select particular individuals with whom they maintain affiliative relationships. Even in adult Japanese macaques, a pattern exists of becoming increasingly selective with age when choos-

ing affiliative partners (Nakamichi 2003). The mechanisms behind many of these transitions are still unknown.

How has affiliation been studied in primates? Affiliation in nonhuman primates is typically inferred from diverse specific behaviors, including proximity, contact, play, and grooming, and some evidence is available on neurobiological correlates. Winslow et al. (2003) found that nursery-reared juvenile rhesus monkeys had lower cerebrospinal fluid (CSF) oxytocin (OT) levels and spent less time engaging in affiliative behavior with peers than did mother-reared animals. In addition, CSF OT levels were significantly positively correlated with time spent affiliating during tests of social interaction. Intracerebroventricular administration of OT in squirrel monkeys increased grooming performed by dominant and subordinate adult males toward females, and also increased affiliative behaviors such as approaches, contact, and huddling in subordinate males (Winslow & Insel 1991b). OT-induced increases in grooming were blocked by prior administration of an OT antagonist. In an interspecies comparison of bonnet and pigtail macaques, Rosenblum et al. (2002) found that the more gregarious and affiliative bonnets had higher CSF OT concentrations than the socially distant pigtails. Schino and Troisi (1992) emphasized the importance of interspecies differences in social tolerance when measuring responses to opiate antagonists, suggesting that affiliative behavioral changes in species with a low degree of social tolerance may be specific to kin relationships, whereas in species with high levels of social tolerance, effects on affiliative behavior may be more general. It remains to be seen whether interspecies differences in behavior will emerge in response to OT administration.

A second approach to studying affiliation in nonhuman primates is to have observers who are familiar with individual animals rate them on a set of traits. Factor analyses of these data have found, in every case, a general dimension, usually referred to as “Sociability,” comprising traits such as affiliative, warm, not solitary, playful (e.g., Capitanio 1999; Stevenson-Hinde & Zunz 1978). Individual differences in Sociability have been linked to a variety of behavioral and physiological consequences (e.g., Maninger et al. 2003). Virtually no neurobiological work has examined affiliation based on the rating methodology, although we have found that animals higher in Sociability have greater dopaminergic sensitivity, as indicated by stronger prolactin responses to haloperidol administration (Ruys et al., in preparation).

Conclusion. Our current knowledge of the psychobiology of affiliation contains a large gap that nonhuman primate research can help fill. D&M-S’s framework provides an excellent starting point for understanding the brain’s role in affiliation. We believe that nonhuman primate research can contribute to such an endeavor in unique ways, affording us a view of affiliation that more closely parallels the processes of interest to us in our own species.

ACKNOWLEDGMENTS

Tamara A. R. Weinstein was supported by training grant MH20006; John P. Capitanio was supported by grants MH49033 and RR00169. We thank William Mason for providing valuable comments on an earlier draft of this commentary.

Serotonin and affiliative behavior

Simon N. Young^a and D. S. Moskowitz^b

^aDepartment of Psychiatry, McGill University, Montreal, Quebec, H3A 1A1 Canada. ^bDepartment of Psychology, McGill University, Montreal, Quebec H3A 1B1 Canada. simon.young@mcgill.ca
dsm@ego.psych.mcgill.ca

Abstract: The possible role of the neurotransmitter serotonin in human affiliative behavior is under-examined in the review by Depue & Morrone-Strupinsky (D&M-S). This commentary reviews evidence indicating that serotonin not only inhibits aggressive behavior that may be detrimental to affiliative bonds with others in a social group but serotonin also enhances prosocial behaviors that may facilitate ties to the social group.

The review by Depue & Morrone-Strupinsky (D&M-S) covers so much ground that inevitably there are areas that suffer relative neglect. The purpose of this response is to expand on how social interactions can be influenced by serotonin, a topic covered only in a two-sentence paragraph in the article. As stated at the end of the penultimate paragraph of section 6.1.3, serotonin “may also promote calm, prosocial interactions, such as allogrooming in vervet monkeys and positive social interaction in young adult humans.” The authors point out at the start of their Concluding Remarks (sect. 9) that “there is a great paucity of *human* neurobiological research on traits that comprise the broad domain of interpersonal behavior.” Serotonin may not be more important than any of the other neurotransmitters mentioned in the article. However, there is a small but growing literature on the role of serotonin in human social interaction, and specifically in behaviors that are involved in affiliation.

The discovery that drugs that potentiate serotonin function have therapeutic effects in various psychiatric disorders led to extensive animal work on the role of serotonin. The traditional view of one aspect of serotonin's role is that it inhibits response to a number of different stimuli (Spont 1992), and there is an extensive literature on the role of serotonin in aggression. Aggression, particularly inappropriate aggression, can lead to social isolation, which, as the authors discuss in section 3.2.3, can lead to an early death in nonhuman primates. Inappropriate aggression, social isolation, and excessive mortality are related to low serotonin levels in rhesus monkeys (Higley et al. 1996). In humans, selective serotonin reuptake inhibitors (SSRIs) can decrease aggression (Coccaro & Kavoussi 1997). Furthermore, SSRIs enhance prosocial behavior in patients with depression (Dubini et al. 1997) and social anxiety disorder (van Vliet et al. 1994). One important question is whether these actions of SSRIs are secondary to the treatment of a disorder, such as pathological aggression, depression, or social anxiety disorder, which disrupts normal social interactions, or whether they have a direct role in the promotion of prosocial behavior. In vervet monkeys, enhancing serotonin function not only decreases aggression but also promotes approach and grooming of other animals (Raleigh et al. 1980), suggesting that serotonin is not just inhibiting response to a stimulus. Recent human placebo-controlled experimental studies suggest that enhanced serotonin function may also promote prosocial behavior in humans.

In studies on healthy volunteers, acute enhancement of serotonin function with either the SSRI paroxetine (Knutson et al. 1998) or with a dietary source of the serotonin precursor tryptophan (Attenburrow et al. 2003) enhanced detection of facial expressions of fear and happiness. Accurate detection of others' moods might contribute to affiliative social interactions. Several studies have shown that enhancing serotonin function also influences social behavior in healthy volunteers. One week of treatment with paroxetine increased affiliative behavior in a dyadic puzzle task (Knutson et al. 1998). In a study of another SSRI, citalopram, given to participants for two weeks, participants were perceived as less submissive by their flatmates and sent more cooperative messages while playing a game with a stranger (Tse & Bond 2002).

The results mentioned thus far were primarily based on observations made in the laboratory or during artificial interactions structured by the investigator. However, advances in methodology have made it possible to study human social interaction in everyday life using an event-contingent recording procedure. This method was developed to examine the multiple occurrences of individuals' social behaviors and their affect in their natural environments rather than in the laboratory. Participants complete a one-page form about their social behaviors immediately after each significant social interaction throughout the day. Abundant evidence has accumulated demonstrating the considerable reliability and validity of this kind of method for assessing interpersonal behavior (Csikszentmihalyi & Larson 1987; Moskowitz 1994). The method developed by Moskowitz (1994) provides assessments of interpersonal behavior corresponding to the two-dimensional

model presented in Figure 1 by D&M-S. In this model, interpersonal behaviors are assessed along two dimensions, dominant-submissive and agreeable-quarrelsome, with the extreme end of quarrelsome behavior corresponding to aggressive behavior. In an event-contingent methodology, these behaviors can vary greatly from one interaction to another, but the reliability of measures aggregated across days increases considerably (Brown & Moskowitz 1998). Using this method, the effect of tryptophan, a nutritional supplement that enhances serotonergic activity, was studied in healthy volunteers using a crossover design during nine days of tryptophan supplementation and nine days of placebo administration (Moskowitz et al. 2001). Tryptophan decreased quarrelsome behaviors and increased dominance. In another study of similar design conducted with participants who had higher than average levels of irritability and hostility, tryptophan not only decreased quarrelsome behaviors but also increased agreeable behaviors (van der Rot et al. 2004). Under some circumstances it also increased the perception of agreeableness in others. The participants were apparently unaware of these changes, as they were not able to guess better than chance when they were on tryptophan and when on placebo.

The studies described suggest that serotonin has a role in promoting affiliative behaviors in human adults in everyday life. This effect is probably not only a result of the ability of serotonin to inhibit aggressive responses but also a result of the ability of serotonin to facilitate prosocial behavior. Serotonin is probably not more important than a variety of other neurotransmitters in regulating social behavior, but the variety of pharmacological and dietary tools available to manipulate serotonin function in humans have helped the study of the role of serotonin to progress.

D&M-S specifically raise the issue of psychobiological processes underlying affiliative bonding. Whether serotonin affects bonding is not yet known. However, animal studies suggest that repetitive, rhythmic, oral buccal motor activity, such as occurs during breast-feeding, activates central serotonergic neurons and serotonin release (Jacobs & Fornal 1995; Rueter et al. 1997), which raises the possibility that activation of serotonin neurons during feeding helps infants bond to their mothers.

The ability of serotonin to enhance recognition of faces as well as alter actual social behavior suggests that serotonin may be acting through more than one mechanism to influence social behavior. Following suggestions of D&M-S, it may be informative to examine further the role of serotonin in changes in the perceptions of others as an incentive for affiliative behaviors and changes in the value and arousal level of rewards associated with affiliative behavior, so as to better understand the complex psychobiological underpinnings of affiliative behavior.

Trust: A temporary human attachment facilitated by oxytocin

Paul J. Zak

Center for Neuroeconomics Studies, Claremont Graduate University, Claremont, CA 91711-6165; Department of Neurology, Loma Linda University Medical Center, Loma Linda, CA 92354; and Gruter Institute for Law and Behavioral Research, Portola Valley, CA 94028. paul.zak@cgu.edu
<http://fac.cgu.edu/~zakp>

Abstract: Trust is a temporary attachment between humans that pervades our daily lives. Recent research has shown that the affiliative hormone oxytocin rises with a social signal of interpersonal trust and is associated with trustworthy behavior (the reciprocation of trust). This commentary reports these results and relates them to the target article's findings for variations in affiliative-related behaviors.

Depue & Morrone-Strupinsky's (D&M-S's) remarkable review of the neurobiology of affiliation lacks only in the paucity of direct human evidence. This commentary reports new findings support-

ing their primary contention that affiliation is an essential human trait.

My lab has been studying the physiology of a temporary human attachment, interpersonal trust. Trust is so frequent in quotidian activities that we hardly notice it. Trust among family members and friends is unsurprising because of the value of repeat bidirectional cooperation. What is surprising is that humans trust unrelated strangers quite easily and often with substantial resources. Consider how many strangers you trust to fly an airplane safely, to prepare your food, and to invest your hard-earned money. A conditional psychology supporting interpersonal trust is essential for humans to live among large numbers of unrelated others in modern societies (Pedersen 2004; Zak 2003; Zak & Knack 2001).

Zak and colleagues hypothesized that this conditional psychology would utilize the neuroendocrine architecture for affiliation and social recognition (Zak et al. 2004). In this study, trust and trustworthiness were operationalized using a paradigm from experimental economics using monetary transfers. Money is used so that participants' decisions to trust others or to be trustworthy have personal costs and benefits, seeking to mimic why humans trust others outside the laboratory. In each experimental session, 12 to 16 subjects from a large California public university earned \$10 for showing up at the lab, were randomly assigned to the role of decision-maker 1 (DM1) or decision-maker 2 (DM2), and were placed in DM1-DM2 dyads through proprietary software. Subjects were informed that their own decisions and those of the other DM in the dyad affected how much money they earned during the experiment, but they were unable to communicate directly with the other DM. There was no deception of any kind.

During the experiment, DM1s were queried by the software to send an integer amount of their \$10 show-up compensation, including zero, to the DM2 in their dyad. Both DMs were advised that whatever DM1 sent to DM2 would be tripled in DM2's account. After DM1s' decisions, the software reported to DM2s the tripled amount that the DM1 in their dyad sent them and the total in their account. DM2s were then prompted to send some integer amount, including zero, to the DM1 in their dyad. Researchers in experimental economics agree that the transfer from DM1 to DM2 is a signal of trust; relatedly, the amount DM2 returns to DM1 is an index of trustworthiness (Smith 1998). Here's the logic: DM1 sacrifices some of his or her show-up earnings by transferring them to an unknown DM2 to signal that the "pie" just got bigger and that the DM1 trusts DM2 to share some of this largess. DM1 can send a stronger trust signal only by sacrificing more of the show-up amount. Similarly, DM2 can only reciprocate trust by taking money out of his or her account – every dollar transferred to a DM1 reduces DM2's earnings one-to-one (and is not tripled).

Each participant was told that he or she would make a single decision and would do so serially. Immediately following each DM's decision, 28 ml of blood was drawn from an antecubital vein. After all decisions, subjects were privately paid their earnings in cash. Each experimental session began at 1:00 p.m., a time of minimum diurnal hormone variation. We conducted two experimental conditions. In the Intention condition, the trust social dilemma just described was implemented; in the Random Draw condition, a separate group of DM1s publicly pulled a numbered ball from an urn. The urn contained 11 balls numbered 0, 1, . . . 10, corresponding to the set of choices that DM1s could make in the Intention condition. The Random Draw condition removes the intentional signaling element from DM1's decision while maintaining the other aspects of the experiment. This allows an identification of the behavioral and endocrine effects of the trust signal.

DM2s who received an intentional trust signal had nearly twice the oxytocin (OT) levels as DM2s in the Random Draw condition (Intention mean OT = 340.87, SD = 130.50 pg/ml; Random Draw mean OT = 197.75, SD = 165.23 pg/ml; *F*-test, one-tailed, *N* = 38, *p* < .004), even though the monetary transfers received by DM2s in both conditions were on average identical (*F*-test, two-tailed, *p* > .87). The two conditions also resulted in different

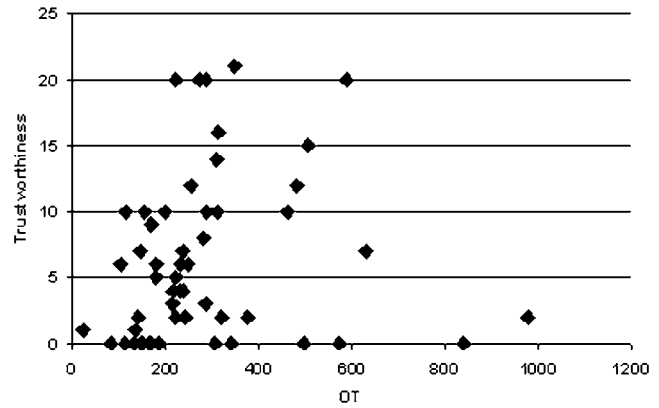

Figure 1 (Zak). OT levels and trustworthy behavior (dollars returned by DM2 to DM1 after tripled transfer from DM1 to DM2) for DM2s receiving an intentional signal trust.

behaviors. DM2s who received an intentional trust signal returned an average of 53% of the amount they received from the DM1 in their dyad. In the Random Draw condition the mean DM2 return to DM1 was zero (*t*-test, two-tailed, *p* > .45).

OT levels in DM2s were also related to their behavior in the Intention condition. Using a multiple regression model, the percentage that DM2s returned to DM1s (relative trustworthiness) was statistically related to OT(+) and OT²(-) (one-tailed *t*-test, *p* < .035), and an indicator of ovulation (progesterone > 3 ng/ml; one-tailed *t*-test, *p* < .036), including age, gender, and a fainting indicator (*N* = 3) as covariates. Our finding that ovulating women were statistically less trustworthy is consistent with evidence that progesterone inhibits OT receptor binding (Grazzini et al. 1998). It provides evidence that oxytocin facilitates trustworthiness directly, rather than indirectly. None of eight other hormones assayed were related to DM2s behaviors directly or indirectly through their effect on OT.

These results support the role of affiliative hormones in responding to an experimental state. We also have evidence supporting D&M-S's assertion that affiliation is a human trait using an extensive social and affect survey. Trustworthy behavior by DM2s was related with three measures of calm affect (*p* < .04), but not robustly with any of the other 189 survey questions. Figure 1 shows a positive relationship between OT and trustworthy behavior in the Intention condition (*N* = 77), with five DM2s who had high OT (> 400 pg/ml) after a trust signal, but were not very trustworthy (return transfer ≤ 7). We investigated traits that differentiated these five "usual" participants from the others and found that they exhibited labile affect on four self-report measures, were usually sexually active, said that they thought others were trustworthy, and evaluated themselves as very trustworthy. They also stated that accumulating wealth while others lived in poverty was acceptable. Though these results are based on a small sample and should be taken with caution, they suggest that a lack of trustworthiness after receiving a signal of trust is associated with identifiable personality traits.

Serotonin, dopamine, and cooperation

Daniel John Zizzo

School of Economics, University of East Anglia, Norwich, NR7 4TJ, United Kingdom. d.zizzo@uea.ac.uk <http://www.uea.ac.uk/~ec601>

Abstract: Whether or not trait affiliation correlates with human behaviour needs investigating. One should be careful generalizing neuropsychological mechanisms for affiliation, and generalizing an analysis based on one or two neuropsychological mechanisms and mostly studies on rodents, to complex human social interactions. Serotonin is an example of a neurotransmitter playing an important role in cooperation and interacting with the dopaminergic system.

Depue & Morrone-Strupinsky (D&M-S) are right to distinguish Agreeableness/affiliation from Extraversion, though one could quibble that Big Five Agreeableness or equivalent constructs are still too general a notion, at least when it comes to the complexity of human personality (e.g., Ashton et al. 2004). If it is behaviour we are interested in, we should worry about the inadequate connection between questionnaire or psycholexical studies on personality types and actual behaviour. One can hypothesize that Agreeableness *should* predict cooperation, but there is very little empirical work demonstrating this link. In current joint work with Marco Perugini and Jonathan Tan, we have been exploring whether Agreeableness predicts cooperation in a repeated public good contribution experiment; preliminary results have been fairly inconclusive (though suggestive of a gender effect), and we plan extra sessions to increase statistical power.

D&M-S are commendably careful to limit their analysis to the affiliation trait. In relation to the discussion of the corticolimbic-atrial circuit for acquisition of context-incentive memories, however, they seem to play their hand rather more generally. This is probably a mistake. We know enough about emotion-driven reinforcement to know that, for example, the amygdala is not always involved. For example, perception of anger-inducing visual stimuli (a clear negative reinforcer) may result in amygdala activation. However, according to Berthoz et al. (2002), no fMRI functional imaging study has been able to detect amygdala activation in response to angry faces, and Sanfey et al.'s (2003) fMRI study on ultimatum game play is consistent with this negative finding. In PET studies where anger was induced without the aid of visual stimuli, the amygdala was not activated (e.g., Dougherty et al. 1999). The same result of no amygdala activation was replicated in a PET study in which subjects recalled events that would make them angry, and were subsequently shown three angry faces (Kimbrell et al. 1999).

The authors highlight the role of dopamine as an encoder of reward. There is indeed considerable evidence (some of which is reviewed in Zizzo 2002b), formalized for example in the model by Schultz et al. (1997), suggesting that the activation level of dopamine neurons works as a "behavioural adaptive critic"; that is, it tells the agent how to adapt its behaviour to successfully deal with the task. The predictability of rewards is essential in modulating human brain response. Redgrave et al. (1999) and Horvitz (2000), however, have noted how dopamine release may be dissociated from hedonic experience to a larger degree than the "behavioural adaptive critic" view would suggest. They observed how sufficiently arousing stimuli of any kind can activate the dopaminergic system: these include unexpected strongly aversive stimuli, but also novel highly salient stimuli without reinforcement value. In this alternative view, saliency, rather than reward, would drive dopamine release. Dopamine would enable an agent to switch attention and corresponding behavioural and cognitive resources to potentially important stimuli.

There are obvious pitfalls, which the authors do recognize, ranging from generalizing an analysis based on one or two neuropsychological mechanisms and mostly studies on rodents to the complexity of human social interactions. Serotonin is an example of a neurotransmitter that is known to play an important role in the development of cooperation and social skills but is almost en-

tirely neglected in the target article (except for a quick nod in the discussion of the consummation phase). In monkeys, there is a positive correlation between social cognitive skills and serotonin levels (e.g., Higley & Suomi 1996), at least within an optimal range. For example, in adolescent male rhesus monkeys, lower levels of serotonin are correlated with high levels of wounding and inappropriate aggression, but not with the kind of contained aggression required from time to time to maintain social status (Higley et al. 1992). As the outcome of inadequate social competence, low serotonin monkeys are likely to develop less affiliative bonds with other monkeys. Mehlmann et al. (1995) found a Pearson correlation of 0.43 between serotonin and time spent grooming and in close proximity with other monkeys; because of their inferior integration in their social group, low serotonin adolescent rhesus monkeys are the first to emigrate from their natal groups. Socially deprived monkeys (grown up alone, without social contacts) present abnormally high levels of serotonin and poor social skills (e.g., Kraemer et al. 1989). In Knutson et al. (1997; 1998), mentally healthy human subjects were found to be significantly more cooperative in a joint problem-solving task if treated with serotonin. In addition, Knutson et al. also took questionnaire measures based on the Buss-Durkee Hostility Inventory Scale and the Watson et al. (1988) Positive and Negative Affect Scale. They found a significantly less "negative affect" and more "positive affect" in subjects with higher blood serotonin levels. The main function of serotonin appears to be cognitive. It determines how optimally agents perceive and behave in social interactions (Zizzo 2002a).

Unfortunately, we know too little about the relationships among the dopamine, norepinephrine, and serotonin systems. It appears that compounds affecting only serotonin also have modulatory effects on dopamine and norepinephrine (Feighner 1999), and it has been hypothesized that serotonin regulates the activity of dopamine neurons (e.g., Steckler & Sahgal 1995). Interestingly, serotonin, dopamine, and norepinephrine are closely correlated in normally reared monkeys, but not in socially deprived monkeys (Kraemer et al. 1989).

More generally, much of the human work on dopamine is based on elementary preferences in simple decision-making tasks, and grand statements about the neural basis of value and reward (as in Montague & Berns 2002) appear somewhat premature in the light of the complexities of the neural development of prosocial motivation and social skills in primates (e.g., Zizzo 2003).

It's a long way up from comparative studies of animals to personality traits in humans

Marvin Zuckerman

Department of Psychology, University of Delaware, Newark, DE 19716. zuckerma@udel.edu

Abstract: Depue & Morrone-Strupinsky (D&M-S) have elaborated a detailed description of the motivational system for affiliation and its neurological basis. This "bottom-up" approach, based almost entirely on studies of nonhuman species, fails to connect with personality differences at the human level. A "top-down" approach looks for common biological markers in human and nonhuman species and relates these to behavior in both.

Depue & Morrone-Strupinsky (D&M-S) have contributed an impressive and ambitious attempt to define a brain-behavioral model for the human trait of affiliation. Previously, Depue and Collins (1999) did the same for the broader trait of extraversion. Their extensive "bottom up" approach (animal brain-behavioral to human trait) is similar to what Gray (1982) did for the traits of anxiety and impulsivity, identifying motivational systems and attempting to show their biological bases in brain systems mediated by specific neurotransmitters. To their credit, Depue and Collins and D&M-S have taken greater pains to define the trait at the human level through factor analyses of questionnaire-measured traits. Gray

(1987) tried to rationally fit his animal-derived dimensions into the Eysenck (1967) three-factor model with questionable success. Bottom up and top-down approaches may not mesh unless there are biological markers at both levels to identify common systems. Behavioral analogies are not sufficient to make the connection. The authors report only one experiment at the human level, whereas more than 95% of the text deals with animal studies. Even here, one particular species, the prairie vole, is relied on for the specific biology of affiliation as compared to the broader question of incentive motivation related to extraversion. There is practically nothing on apes, our nearest cousins in the evolutionary chain. But then chimpanzees, the most closely studied ape, are not monogamous although they exhibit other types of pair bonding. Rats and mice, from which most of the studies are derived, demonstrate only mother–infant bonding. Therefore, we must rely mostly on data from one type of prairie vole for study of heterosexual affiliation. When we get down to specific neurochemical pathways and their functions, one wonders how much species specificity is involved.

I heartily support a comparative approach to the psychobiology of personality (Zuckerman 1984; 1991), but I favor a top-down one in which biological markers associated with the personality and behavioral traits in humans can be identified in other species and associated with behavioral traits in them.

An example of this method is the use of a psychophysiological marker, which augments or reduces the visual or auditory cortical evoked potential (EP) in relation to disinhibited sensation seeking. Augmenting is defined as linearly increasing amplitudes of the EP in response to increasing stimulus intensities. High disinhibitors tend to be augmenters and low disinhibitors tend to be reducers (no increase in EP and even decreases at the highest intensities) (Zuckerman 1990; Zuckerman et al. 1974). Siegel extended the human EP paradigm to cats and found that augmenting and reducing cats demonstrated behavioral differences similar to those of human high and low sensation seekers in response to novel stimuli and situations (Lukas & Siegel 1977; Saxton et al. 1987). The reducer cats showed superior learning in a situation requiring restraint of rate of response to obtain reinforcement. The augmenting cats were too impulsive.

Siegel then extended the EP paradigm to two genetically selected strains of rats and found that nearly all of those in an actively avoidant or aggressive strain were augmenters, whereas nearly all those in a passive low avoidance strain were reducers (Siegel et al. 1993). Now with this physiological link to the human level, the differences between the two strains on behavioral measures assume more significance (Zuckerman 2002). The augmenting strain is more aggressive, willing to ingest alcohol, has high tolerance for barbituates, and self-administers higher intensities of electrical stimulation in reward areas of the limbic brain. The female augmenters spend less time on the nest with their young than do the reducers (low affiliation?). Comparisons of biochemical reactions of the two strains to stress show more dopaminergic reactivity of the augmenting strain in the prefrontal cortex, more serotonergic reactivity of the reducing strain, and more corticotropin releasing factor in the hypothalamus and adrenocortical reaction in the pituitary gland. This kind of top-down approach is able to relate individual differences at the human level with those found among animals by using a common biological marker, in this case the cortical EP response to stimulus intensity.

Endogenous opiates, gonadal hormones, oxytocin (OT), and vasopressin are assumed to play a role in the seeking of affiliative rewards. Opiates are said to work by “bringing affiliative interactions to a gratifying conclusion” (target article, sect. 6.3.3.2). Perhaps one would expect to find low levels of endorphins in persons seeking affiliative rewards. In opiate drug dependents, the opiates seem to obviate the need for affiliation. Sensation seeking is positively related to both extraversion and sociability and negatively related to affiliation (Zuckerman 1979; 1994b). But chronic pain patients with low endorphin levels in cerebrospinal fluid have

higher levels of sensation seeking than those with high levels of endorphins (Johansson et al. 1979). Low levels of endorphins were found in subjects who were augmenters on the EP. Testosterone is positively related to sensation seeking, sociability, sexuality, and aggressiveness but not to affiliative needs. Women tend to be higher than men in affiliation and perhaps this is related to estrogen, but certainly not to testosterone.

Gray (1982; 1987) and Depue and Collins (1999) have given us extremely detailed neurobehavioral concepts of the behavioral expressions of anxiety, extraversion, and affiliation, extrapolated from a rich bed of comparative research, but there is a long way to go in relating these mechanisms to personality differences in normals. The brain was not designed in terms of personality traits, phenology to the contrary. The same tracts and neurotransmitters serve many functions, including perceptual, cognitive, and emotional ones. Identification of particular neuropathways for particular functions is problematical. It ignores the interactions between systems at the molecular levels. D&M-S have given us enough hypotheses to keep neuroscientists busy for many years to come.

Authors' Response

Modeling human behavioral traits and clarifying the construct of affiliation and its disorders

Richard A. Depue and Jeannine V. Morrone-Strupinsky

Laboratory of Neurobiology of Temperament and Personality, Cornell University, Ithaca, NY 14853. rad5@cornell.edu jvm1@cornell.edu

Abstract: Commentary on our target article centers around six main topics: (1) strategies in modeling the neurobehavioral foundation of human behavioral traits; (2) clarification of the construct of affiliation; (3) developmental aspects of affiliative bonding; (4) modeling disorders of affiliative reward; (5) serotonin and affiliative behavior; and (6) neural considerations. After an initial important research update in section R1, our Response is organized around these topics in the following six sections, R2 to R7.

R1. An important update

In our target article, we proposed that (a) a critical component of affiliative bonding is a core capacity to experience reward from interacting with others, and (b) μ -opiates mediate this form of rewarding experience. To date, there had been no direct test of that proposal in animals. Recently, Moles et al. (2004) published results in *Science* that support our proposal; that is, mice lacking the μ -opioid receptor gene showed a severe deficit in attachment behavior. This study also is concordant with Zubieta et al.'s (2003) findings of regulation of human affective responses by limbic μ -opioid neurotransmission, and is consistent with our results of human affiliative response modulation by naltrexone, presented in the target article. Additional work along these lines is strongly encouraged.

R2. Strategies in modeling the neurobehavioral foundation of human behavioral traits

Three commentaries address the general issue of which strategies in modeling the neurobehavioral foundation of human behavioral and personality traits are most effective. Our strategy in this target article, as well as in a previous one (Depue & Collins 1999), is delineated in Figure 2 of the target article. It is a top-down model in terms of behavioral analysis, starting with a detailed analysis of the core behavioral features of a trait (e.g., affiliation) that comprise the main item content of most personality questionnaires. Because we conceive of the core features of personality traits as representing emotional-motivational systems that evolved to recognize, evaluate, and respond to critical stimuli in the environment, which is a framework first proposed by Gray (1973) and more recently in relation to social behavior by Ghazanfar and Santos (2004), a detailed analysis at the human behavioral level should lead to a corresponding behavioral-motivational system in other mammals – at least with respect to the core or central features of the phenotype, if not to all behavioral features. As we note in the target article, there is good reason to assume some concordance between human and other mammal behavioral systems that comprise personality, including affiliation (Byrne & Suomi 1998; Capitanio 1999; Capitanio et al. 1998; Champoux et al. 1997; Gosling 2001; Itoh 2002; Pfaus et al. 1999). If one is ultimately interested in defining the neuroanatomical networks and neuromodulators underlying behavioral-motivational systems, it seems to us that this is the preferred strategy (and has been the main strategy underlying the derivation of animal models to illuminate human behavior and behavioral disorders for decades). It is only in animal research where one can define the neurological-neurochemical links to behavior with sufficient detail to be meaningful. Our strategy progresses by assessing the animal behavioral neurobiology literature associated with a relevant behavioral-motivational system, and that analysis is then used in a bottom-up manner to generate hypotheses about the underlying neurobehavioral foundation of a human behavioral system.

Zuckerman argues that “bottom-up and top-down approaches may not mesh unless there are biological markers at both levels to identify common systems. Behavioral analogies are not sufficient to make the connection.” He favors a top-down approach in which biological markers associated with the personality and behavioral traits in humans can be identified in other species and associated with behavioral traits in them. This seems to us a reasonable strategy, but we believe that it is a weaker one for several reasons. First, there is a reason that Zuckerman provides only *one* example of such a biological marker – augmenting/reducing of cortical evoked potential (EP). No other association of a biological marker with a personality trait is established, though this is not for a lack of trying. There is some headway being made in relating genetic polymorphisms to personality, but only one variable appears to have been reliably demonstrated to date (Munafò et al. 2003). Why is there a paucity of candidate biological markers in humans? We believe that it results from the weakness of the top-down strategy heralded by Zuckerman. The major weakness is that, without being informed with details derived from animal literature, the biological markers have tended to be relatively nonspecific in two ways. First, the

biological variables themselves used in human studies have tended to lack specificity. For example, (a) cortisol can reflect many different physiological and stimulus events, (b) use of pharmacological agonists not specific as to receptor subtype diffuses conclusions, (c) cortical EP reflects many neurological processes, and (d) psychophysiological measures of autonomic processes (long a favorite set of measures) are less capable of reflecting central neural processes directly, and so forth. If no specific hypothesis about the association of biology and behavior is derived from animal literature, there is insufficient guidance for selecting specific biological variables in humans.

This nonspecificity leads to a second weakness of the top-down biological strategy; that is, nonspecific variables are associated with many different brain networks and neuromodulators, and with many different psychological processes. As discussed by **Zuckerman**, augmenting/reducing cortical EP is related in animals to several behavioral features (restraint, impulsivity, avoidance, aggression, alcohol ingestion, tolerance to barbiturates, level of stimulation for reward, females spending less time on nests with young) and several neuromodulators (dopamine, serotonin, corticotropin-releasing hormone, testosterone, and adrenocortical reaction in the pituitary gland), as well as to several human personality traits (sensation seeking, extraversion, sociability, affiliation). What are we to make of such a large number of nonspecific associations, and how do they help us to understand the relation of human behavioral traits to animal traits? This may be one reason that, outside of the studies by Zuckerman and his students, EP has not generally illuminated the specific neurobehavioral nature of any personality trait.

Panksepp & Moskal's comments are relevant to these latter points. They believe that one must perform “optimal levels of analysis” at both the animal behavioral-neurobiology level and at the human behavioral-psychological level. Although they applaud our analysis at the human psychological trait level, they believe that we have provided a *too* detailed analysis at the neuroscience level – that the level of detail is not useful for generating hypotheses about the neurobehavioral nature of psychological traits or “functions” at the human level. We could not disagree more. If anything, one of the problems with biological formulations of human behavioral (personality) traits has been their lack of specific details, such that one hardly knows where to begin specific experiments of the hypotheses. It may be that Panksepp's own truly remarkable insight published in 1980 (cf. Panksepp et al. 1980) concerning an association between opiates and affiliation did not generate significant attention, as he and Moskal justifiably lament in their commentary, until lately. Indeed, 18 years later in Nelson and Panksepp's review of opiates and social attachment (Nelson & Panksepp 1998), there is insufficient specificity, in our view, about the nature of that association to lead to specific empirical work. Without specific details, the problem of diffuse associations with multiple psychological functions, as discussed here, is present.

We would emphasize that we agree with **Panksepp & Moskal's** implicit point, that an array of specific neuroscience details that are not integrated around behavioral functions in animals would leave the reader lost as to how to proceed empirically. In our view, we do not do that at all. We strived to integrate the neuroscience details around behavioral functions that we believe are crucial underpinnings

to the formation and maintenance of affiliative bonds, specifically different forms of reward processes, the processing of affiliative cues in particular, and the acquisition and maintenance of affiliative memories. Within the domain of each behavioral process, we attempted to provide as much detail as the literature justified. We can see no advantage in ignoring the details in favor of an overview that is too simplistic to lead to specific hypotheses *about the relation between specific biological variables (e.g., μ -opiates) and specific behavioral functions (e.g., affiliative reward).*

In his thoughtful commentary, **Munafò** provides examples of why nonspecificity is problematic. In the genetic domain, he notes that “if we are to ascertain the genetic determinants that influence the development of these traits we will be far more likely to be successful if a clear neurobiological pathway is described through which such determinants may exert their influence. This, in turn, will enable far more specific predictions to be made regarding the candidate genes that one might reasonably expect to be associated with these traits.” This was certainly borne out in the Moles et al. (2004) study, which successfully associated specifically μ -opiate receptor gene function and attachment. Moreover, Munafò makes the excellent point that “any subsequent development of a psychometric instrument will require close integration with genetic data, for example, to enable the selection of individual questionnaire items on the basis of their association with selected candidate genes.”

Panksepp & Moskal's argument is one heard from others who criticize “reductionistic” approaches to complex human behavior. Hence, another point is worth making. It is the details of the association of neurobiological variables and psychological processes that are critical for empirical testing of hypotheses. For example, just to pronounce that opiates are related to affiliation would not lead to the specific study of Moles et al. (2004), nor lead to a test of our hypothesis by assessing specifically μ -opiate receptor gene polymorphisms in humans in relation to affiliation. In addition, if one wanted to test the hypothesis that dopamine functioning is related to extraversion, as we have suggested (Depue & Collins 1999), such tests would likely be more revealing if the details of the association of dopamine to psychological functions are known. Thus, it is important to know not simply that dopamine generally facilitates incentive behavior but rather that dopamine D1 receptors in the nucleus accumbens facilitate (1) the association of contextual cues with reward and (2) the ability of those cues to subsequently motivate conditioned responses (target article), or that dopamine D1 receptors in the dorsolateral prefrontal cortex facilitate visuospatial working memory (Luciana et al. 1998). Knowing such details provides the foundation for empirical tests that employ specific dopamine D1 receptor agonists and specific psychological functions (e.g., Pavlovian contextual conditioning, visuospatial working memory), all of which might lead to more specific tests, for instance, of a relation between dopamine and extraversion (Depue & Morrone-Strupinsky, under review).

Thus, in our view, attending to the fine neuroscience details of animal behavior provides more specific hypotheses for studying that neuroscience in humans, both at the genetic level and at the level of neurochemical associations with complex behavior. Such specificity at all levels – behavioral features of a trait, as well as its putative neurobiology and genetics – seems particularly important when con-

sidering complex behavioral traits in humans, for, as **Munafò** astutely notes, not all phenotypic features of a trait, nor measures of those features, are likely to be equally related to a trait's underlying neurobiology or genes. As Munafò puts it, “future research should integrate genetic, behavioral and psychometric research in [specific detail] if the nature of complex behavioral traits is to be fully understood.”

R3. Clarifying the construct of affiliation

Several thoughtful commentaries concern the various components comprising the construct of affiliation, and all basically view our treatment of the construct as too limited. Most of the comments extend the notion of affiliation to many different aspects of social relations among individuals and groups of individuals. **Glassman & Buettner** even usefully extend our constructs to sociability and the role of human community in both ontological human development and human evolution. Therefore, we will try to clarify our definition of the construct discussed in the target article. This can best be done by first outlining the extensions to the construct proposed in the various commentaries.

Weinstein & Capitanio provide an excellent mini-review of the different components they believe should be incorporated in the construct of affiliation. They draw attention to an important distinction that we believe captures the essence of our definition versus other definitions presented in the commentaries. They suggest a distinction between the affiliative disposition of an individual and the larger array of affiliative behaviors that emerge from interactions with other individuals and within groups of individuals. Thus, they note that affiliation is more than a preference or bond, and that relationships are a product of, but separate from, the individual's affiliative disposition. Thus, in primates, initiation and duration of proximity, grooming solicitations, passive contact, frequency and duration of social play, generalized style of social response, and behavior in complex groupings may not all be direct or equivalent manifestations of an affiliative disposition, and hence may not all have a similar neurobiology. They also suggest that affiliation and level of sensation seeking, which they interpret as a proxy for extraversion, or warmth and gregariousness, *which it clearly is not* (Depue & Collins 1999), are not correlated. Moreover, they argue that mating behavior and maternal care are not the same as affiliation. Indeed, they view friendship bonds, which they note may confer no benefit other than the apparent pleasure of companionship, as a better model of affiliation than mother–infant or sexual relationships. For example, they see as a problem for our formulation that interactions between mothers and pups of most rodent species do not suggest anything more than a caregiving relationship, which is not characterized by the experience of social enjoyment or warmth, and which is usually very short-lived. And, finally, they note that affiliation develops, and that with age and experience primates become more selective in their choice of partners.

Brown & Brown extend the construct of affiliation further, noting that social relationships do not just confer benefits, but also have potentially serious costs associated with them, including time and energy spent in territoriality and dominance behavior, possible aggression from others, and social rejection, all of which may be associated with ap-

proach versus withdraw motivational conflicts. Furthermore, conflicting motivations arise when human social bonds, once formed, require altruistic behavior in the form of caregiving to an ill mate, the elderly, and so forth. Thus, they conclude that our model of affiliative bonding, which relies on reward mechanisms, fails to accommodate these motivational conflicts.

Itoh & Izumi indicate that we do not account for the dynamic process of affiliation, the ebb and flow in quantity and quality of affiliative behavior in a relationship over time. Much of the discussion appears to be concerned with “state” affiliative status, rather than a trait disposition for affiliative bonding, which is more our focus. Indeed, Itoh & Izumi state that “the utilization of personality inventory techniques for defining personality traits tends to average out temporal dynamics in behaviors.” Yes, that is exactly what trait estimates do, and it is that average affiliative disposition that interests us. We do, however, discuss in section 8 the dynamic aspects inherent in the acquisition of affiliative bonds as a function of individual differences in affiliative disposition. Itoh & Izumi also point out that we do not discuss the processes involved in the degradation of affiliative bonds, which is true but was not our focus, even though it is an important area of study. But to conclude that we treat affiliative bonds as “a nondecreasing function of time” is incorrect; this simply was not our intention. Indeed, we provide a temporal view of the acquisition and maintenance of affiliative bonds in such a manner that one can, theoretically at least, account for dissolution of bonds, in part, on the basis of extinction of associations between the cues of the affiliative object and reward. Because of space limitations, we could not treat this important topic in any detailed way.

Potter extends the construct of affiliation to the notion of *adopting* something and to second-order, more abstract, affiliative attachments to such things as ethnic groups, ideas, sports teams, religious values, ideals, and even rocks and trees in some Native American groups. This is an interesting problem that likely involves several different processes, including perhaps complex processes of imitation and identification. Whether and how such attachments involve activation of affiliative bonding mechanisms would need to be conceptually postulated and studied.

Finally, in an interesting commentary, **Zak** suggests that the construct of affiliation be extended to even temporary human interactions that involve the establishment of even brief periods of trust in another, which Zak finds elevates peripheral oxytocin levels in blood. Others have shown that humans make a rapid, implicit judgment as to the trustworthiness of another’s face, and that this judgment is associated with variations in amygdala activation (Winston et al. 2002). Thus, whether perception of trust may also serve as an affiliative stimulus that elicits neurobiological processes that facilitate subsequent interpersonal behavior, and that may eventually lead to the establishment of a bond, is an intriguing research question and one that ought to be pursued.

In writing our target article, we predicted that these criticisms would be forthcoming. In section 3.2, we attempted, apparently not successfully, to explain that our focus was much narrower than an affiliation construct that includes all the phenomena discussed here. We treated this problem, probably too briefly, under the term “sociability” rather than “affiliation.” Sociability, affiliation, interpersonal be-

havior – whichever term one wishes to use to refer to the larger domain of social interactions – is a much broader construct than trait affiliation, as we defined it. Affiliation as we defined it in the target article is psychometrically independent from the broader construct of sociability (Lucas et al. 2000). Unfortunately, terminological difficulties often obfuscate the more important issues.

Accordingly, let us try to clarify our construct of affiliation in relation to these commentaries. We believe that central to the broader array of affiliative phenomena that emerge from complex social interactions is a core capacity to experience reward elicited by specific affiliative stimuli, especially those that involve both sexual touch and nonsexual soft, caressive tactile stimulation. This rewarding experience is subjectively experienced as warmth and affection. We believe this capacity is the sine qua non of affiliative bonding. The commentaries by **Miller** and **Katz** recognize our position quite well, and Miller places this capacity within a broader system of bonding that is interesting. Indeed, Katz raises the question of whether the subjective experience of warmth and affection is a basic feeling that accompanies affiliative reward and perhaps other forms of consummatory reward (as well as more abstract, deeply felt reward from, e.g., symmetry in knowledge structures), feelings that may be present unconsciously in lower animals but may emerge into conscious awareness in higher mammals. As Katz suggests, perhaps such feelings are not dissimilar in nature from the warmth experienced by humans and lizards when basking in the sun. As we discussed in the target article, Uvnas-Moberg (1997) and MacLean (1986) have also suggested that basic feelings associated with affiliative bonding originated in physiological and chemical processes associated with warmth, feeding, touch, and so forth. As we also noted in the target article, distinct pathways have evolved, particularly in mammals, for processing soft as opposed to hard tactile stimulation, and both forms of touch can activate opiate responses, indicating that the later-evolving soft touch system used the existing opiate response system as a mediator of warm, calm, affectionate feelings. Moreover, whereas these basic feelings may have originally been unconscious, central representation of the neurobiological and neurochemical processes associated with these feelings has more recently evolved, most highly in primates, particularly within the anterior insular cortex, in which magnitude of neural activity is correlated with conscious experience of emotional feelings (Critchley et al. 2004). In agreement with **Weinstein & Capitanio** and with Miller, we should probably have referred to this core capacity to experience affiliative reward and its subjective representations as comprising an *affiliative disposition* that provides a necessary foundation for an individual’s acquisition and maintenance of close affiliative bonds. The notion of disposition is certainly in better accord with the concepts of personality traits held by many, and connotes a capacity for, rather than an end state of, affiliation.

We would argue that this affiliative disposition is necessary for the development of many of the phenomena included under the construct of affiliation in the commentaries. We believe it originated with mother–infant bonding, and, in contrast to **Weinstein & Capitanio**’s criticism, whether this bond is short-lived or long-term seems to us irrelevant to the origin and existence of such a capacity in the mother–infant pair and for the importance of that capacity to promote acquisition of an affiliative bond. Wein-

stein & Capitanio will have to explain, other than by labeling it as *caregiving*, an alternative mechanism for why mothers stick around and care for their offspring, even if only for a short time. In addition, as Weinstein & Capitanio state, friendships may confer no benefit other than the apparent pleasure of companionship. We could not agree more. But from which process does that pleasure derive? Weinstein & Capitanio do not address this, but we believe that the same affiliative reward capacity can explain this phenomenon, as well as the pleasure derived from mother–infant interactions, sexual mate interactions, and tactile stimulation during play, without the need to introduce a new process or mechanism for bonding within different types of social relationship. We do not, however, wish to suggest that this core capacity accounts for all forms of affiliative behavior or sociability. As **Brown & Brown** note, even a broad “evolutionary view of altruistic and self-sacrificing behavior that typically occurs between close relationship partners is not inconsistent with a reward sensitivity as a necessary *precondition* for forming affiliative bonds.” And, finally, as noted earlier, we believe that our view of the processes involved in bond acquisition and maintenance can meaningfully inform, if not totally account for, **Itoh & Izumi**’s emphasis on bond dissolution. In sum, then, our focus is admittedly a narrow one, being limited to the putative basic mechanisms that provide a necessary foundation for the initial acquisition of affiliative bonds, and for the maintenance of those bonds via social memories in organisms characterized by longer-term affiliative bonds.

R4. Developmental aspects of affiliative bonding

In section 7.3 of our target article, we discussed literature relevant to experiential effects on variation between individuals in affiliative disposition and behavior. Our focus in that discussion was on the potential effects of variation in naturally occurring affiliative experience on an individual’s expression of affiliative behavior, as it is clear that there are strong postnatal effects of social experience inside and outside the family that influence human trait levels of affiliation (Tellegen et al. 1988). In their excellent commentary, **Carter, Bales & Porges (Carter et al.)** extend our target article discussion in section 7.3 by discussing research which shows that prenatal and neonatal exposure to oxytocin (OT) and vasopressin (VP) can generate sustained variation in affiliative behavior, presumably via various mechanisms such as receptor binding. On the basis of such evidence and other studies, **Levine** suggests that OT and VP not be seen as having a “mere facilitatory role” in affiliative behavior, but rather a complementary and interacting role to opiates. For us, facilitatory is equally complementary and parallel, as shown in Figure 3 in the target article; what we believe the evidence indicates is that OT and VP do not mediate the affiliative reward necessary to acquire an affiliative bond. **Swain, Mayes & Leckman (Swain et al.)** similarly demonstrate that endogenous and exogenous exposure to opiates early in life can have a pronounced influence on affiliative behavior, and in the exogenous case they can dysregulate the neural circuitry involved in parenting. Taken together, the implication of these commentaries is that exposure to such neuropeptides during critical times of development may alter trait levels of social behavior permanently via effects mediated by alterations in

parental behavior or by direct neurochemical effects on offspring neural development.

It will be important to establish the extent to which naturally occurring variation in others’ affiliative behaviors (as opposed to early pharmacological manipulation of OT, VP, and opiates) in later postnatal periods can affect long-lasting individual differences in offspring affiliative behavior. Elegant studies by Meaney et al. (2001) and Weaver et al. (2004) clearly suggest that this is a possible source of individual differences in that variation in the style of mothering influences in a long-term manner the degree of stress reactivity and subsequent mothering behavior of offspring. These issues are ones that have attracted attention only relatively recently, but deep conceptual development of the permanent effects of experience on neurobehavioral systems will be needed for this reason: Personality traits, including stress reactivity (anxiety, neuroticism, negative emotionality), extraversion, and affiliation are remarkably stable from adolescence across the life-span. It may well be that the effects of experience are trait-dependent – that a trait-like, stable range of functioning, established on the basis of genetic effects, of neurobiological variables underlying a trait modify the extent to which experience can modify those same neurobiological variables, and hence the phenotypic characteristics of that trait. (See section 7 of the target article and Depue and Collins [1999] for a fuller discussion.)

R5. Modeling disorders of affiliative reward

Three commentaries raise the possibility that dysfunction in, and/or naturally low extremes of, an affiliative reward process, as we have defined it in the target article, may give rise to certain forms of psychiatric and personality disorder. All of these commentaries are especially welcome because we do not address this general area in the target article. The commentary by **Behrendt** provides a novel explanation of autism in reference to our model of affiliative reward. These notions ultimately rely on Panksepp et al.’s (1980) insightful hypothesis that the social deficits of autism may be related to excessive opiate activity, rendering the afflicted individual with little need for externally elicited affiliative reward (Sher 1997). Behrendt, however, provides a more mechanistic discussion, based on recent research, of how autistic individuals may lack adequate responsiveness to affiliative stimuli, and hence subsequent affiliative reward, because of deficits in (a) orienting visually to caregiver social cues, such as smiles and faces, (b) being able to cortically represent the emotional state (e.g., affiliative state) of another, and/or (c) facilitating the processing of social cues because of a lack of oxytocin. Any of these deficits would impair the ability of the autistic individual to form affiliative memories (i.e., associate affiliative cues of the caregiver with affiliative reward), and hence the ability to acquire and maintain long-term affiliative bonds. These hypotheses are novel and deserve empirical exploration.

What we find refreshing in the commentaries of **Pizzagalli & Deveney** and **Troisi & D’Amato** is that they suggest that extreme behavioral variation and/or dysfunctional behavior may have their origins in naturally occurring neurobehavioral systems. Put differently, these systems may provide the foundation in which extreme variation or dysregulation creates behavioral disorder. We applied the same

logic previously to affective disorders (Depue & Iacono 1989) and recently to personality disorders (Depue & Lenzenweger, in press; 2005), so these excellent extensions of such a model are most welcome. Several points are worth considering. In their commentary, Pizzagalli & Deveney suggest that major depressive disorder (MDD) may result from dysfunctional variables that influence the capacity to experience reward (anhedonia). It is important to consider, as we are sure Pizzagalli & Deveney have, that MDD is likely to be an exceedingly heterogeneous group of disorders that may involve dysfunction in several naturally occurring behavioral systems. For example, capacity to experience reward could derive from dysfunction in either consummatory or incentive reward systems, as outlined in the target article. The behavioral features associated with dysfunction in these two systems would likely differ substantially, as might their neurobiology. For instance, Pizzagalli & Deveney note the findings relating MDD to dopamine dysfunction. We would suggest that such findings could equally implicate the incentive system, and we have previously modeled the association of dopamine functioning, the incentive motivational system, and bipolar affective disorder (Depue & Iacono 1989). In this model, a dysfunction in the dopamine system, or a system that strongly modulates the dopamine system, causes extreme fluctuations in dopamine functioning, creating hypomanic/manic behavior when elevated, and depression when low. Note that the depression in bipolar disorder is characterized by an absence of positive affective reactivity more than negative affectivity, which is in keeping with the phenotypic characteristics of the low extreme in a dimension of positive affect in the normal population (Watson & Tellegen 1985). We have shown that it is this dimension, akin to extraversion at a trait level, which is related to dopamine functioning (Depue et al. 1994; Depue & Morrone-Strupinsky, under review). It may be that other forms of MDD reflect a deficit in the capacity to experience consummatory reward, and in this case a model based on opiate dysfunction might apply as aptly. Furthermore, because MDD frequently presents as a mixture of depression and anxiety, MDD in this case might represent a joint dysfunction in reward systems and an anxiety system.

The commentary by Troisi & D'Amato considers the emergence of personality disorders from extreme variation in an affiliative reward process, focusing on schizoid, antisocial, and dismissing attachment (the latter being, simply, extremely weak attachment to others). We also have modeled these conditions as involving an extremely low capacity in affiliative reward (Depue & Lenzenweger, in press; 2005). The phenotype described for dismissing attachment appears to represent the extremely low end of a dimension of affiliative reward, where individuals feel little pleasure, warmth, or affection in interacting with others, and hence display little affiliative behavior (e.g., holding hands, mutual gazing, cuddling, kissing). This phenotype is exactly like that characterized by the extreme low end of Tellegen's trait measure of Social Closeness (Tellegen & Waller, in press). This appears to be a prototypical instance of a primary deficit in affiliative reward capacity. Like Troisi & D'Amato, we have suggested that schizoid disorder is characterized by reduced affiliative reward, but we have added a reduced functioning in all other affective behavioral systems, including positive emotionality (extraversion) and negative emotionality (anxiety, neuroticism) (Depue & Lenzenweger 2005). In contrast, antisocial personality may emerge

from a combination of low affiliative reward, reduced anxiety, and elevated aggression and impulsivity. We describe the neurobehavioral systems underlying all of these traits in Depue and Lenzenweger (2005).

The emergence of different forms of weak affiliative reward is illustrated more formally in Figure R1, where the nature of an individual's interpersonal behavior is dependent on the relative strength of agentic extraversion and affiliation. Agentic extraversion is associated with social engagement and dominance, whereas affiliation reflects the capacity to experience reward from affiliative interactions. As discussed in section 2 of the target article, theories and research on interpersonal behavior have demonstrated that these two traits are independent and characterize most of the variance in interpersonal behavior. As illustrated in Figure R1, their interaction produces substantive differences in interpersonal style. Affiliation at the high end modulates the dominance and competitive aggression of agentic extraversion, creating an *amiable* interpersonal style ranging from follower to leader depending on the level of agentic extraversion. Perhaps more relevant to personality disturbance, the low end of affiliation manifests as aloof, cold, and uncaring, which ranges from isolated and submissive to manipulative and domineering with increasing levels of agentic extraversion. The left lower quadrant is reminiscent of clinical descriptions of schizoid behavior, whereas the lower right is more in keeping with antisocial behavior.

An additional trait interaction alluded to by Troisi & D'Amato seems particularly relevant to characterizing interpersonal behavior in personality disturbance – that is, an interaction between affiliation and separation anxiety or distress. The latter trait is rarely assessed in personality inventories, but it is a significant influence in most interpersonal relations at one time or another, and becomes impairing at extreme levels (e.g., borderline personality disorder). Although manifestation of separation anxiety or distress is correlated with the existence of an affiliative bond, we take the position with others (Insel 1997; Nelson & Panksepp 1998; Panksepp 1998; Young et al. 1998) that processes underlying affiliative bonding are not the same as those involved in social separation distress. Affectively, affiliation and separation are distinctly different and not two sides of a coin. Separation is characterized by the presence of frustration, protest, and anxiety, and not just the absence of warmth and pleasure (and vice versa). In fact, there are data that support a bidimensional organization of affiliation and separation distress because the neural pathways underlying affiliative engagement (e.g., maternal behavior) are different from those that allow for inhibition of separation distress (Eisenberger et al. 2003; Insel 1997; Nelson & Panksepp 1998).

As outlined in the target article, separation anxiety or distress may reflect the anxiety of *uncertainty* generated by removal of protective and supportive social safety cues. From a broader evolutionary perspective, separation leading to social isolation can be characterized as unconditionally aversive, having *no discrete, explicit stimulus source* – similar to the human experience of being in unfamiliar environments, or in the dark, or open spaces (Davis & Shi 1999; Davis et al. 1997; White & Depue 1999). In humans, social isolation, rejection, and/or ostracization generate a sense of anxiety, guilt, and apprehension. It may be that separation anxiety or distress is associated with other related traits such as rejection sensitivity and dependency, both of which reflect anxiety over social isolation. This system would be as-

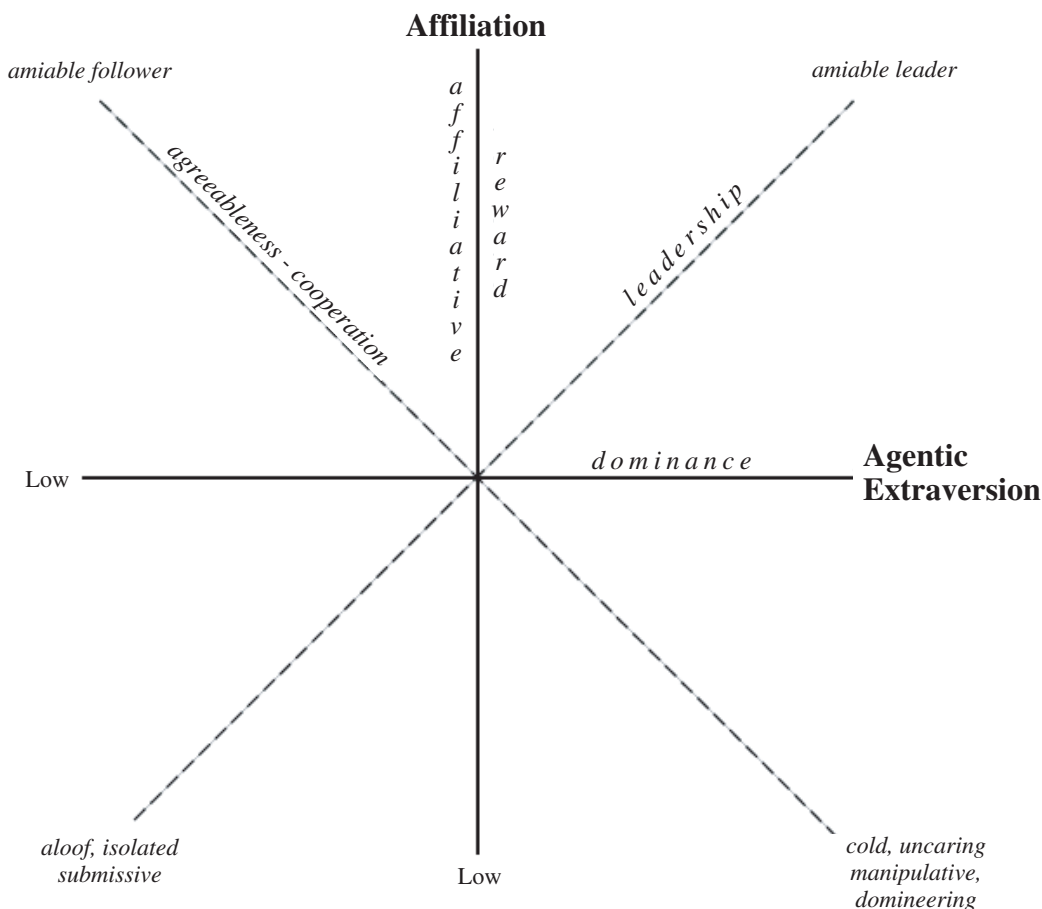

Figure R1. Interaction of the higher-order personality traits of agentic extraversion and affiliation.

sociated with neural networks involved in recognition of social uncertainty and rejection, experience of psychic pain (Eisenberger et al. 2003), and expression of anxiety.

As illustrated in Figure R2, the dimension of separation distress is portrayed as one of degree of dependency on other people for support and feelings of security. In interaction with affiliation, the four quadrants can be seen to represent four different social attachment styles frequently described in the literature: (1) *secure* (upper left), where the individual is affectively bonded and not overly distraught with anxiety about losing that bond, and is therefore socially gratified; (2) *ambivalent* (upper right), where the individual is adequately bonded but has intense anxiety about separation from the bond, thereby vacillating between the desire for closeness and a protective interpersonal distance. It is in this quadrant that one might expect borderline-, avoidant-, and dependent-like interpersonal disturbance. Moreover, when this quadrant is accompanied by elevation on the higher-order trait of anxiety, the interpersonal disturbance will also be associated with alienation and suspicion of the motives of others, because interpersonal alienation is a strong marker of this trait (Tellegen & Waller, in press); (3) *avoidant-anxious* (lower right), where the individual is not affectively bonded but is anxious about being isolated and alone and thereby avoids loneliness through nonbonded, nonaffective interpersonal relations; and (4) *no affective attachment* (lower left), where there is

an absence of affiliative bonding and little anxiety in being separated from social contact, resulting in a stable absence of social attachment that characterizes schizoid-like interpersonal disturbance.

R6. Serotonin and affiliative behavior

Three commentaries focus on the role of serotonin in affiliative behavior. These are all excellent commentaries that make a good case for further research on the influence of serotonin. **Young & Moskowitz**, and to some extent **Zizzo**, provide a particularly concise, informative overview of serotonin's effects on aggression, which can interfere with social bonding and prosocial behavior, per se. They are correct that we did not treat this topic as comprehensively as it deserves, but our conclusion in the target article is much the same as theirs; that is, serotonin promotes calm, prosocial interactions. It will be important to discover the source of this positive modulation, which we believe is likely to be related to serotonin's inhibitory modulation of behavioral reactivity to most sensory inputs, particularly so for visual input, and to serotonin's inhibitory modulation of other neurotransmitters of broad distribution, such as dopamine (see supporting evidence for this in the commentary by **Netter, Reuter & Hennig** [Netter et al.]) (Depue & Collins 1999; Depue & Lenzenweger 2005; Depue & Spont 1986; Spont 1992).

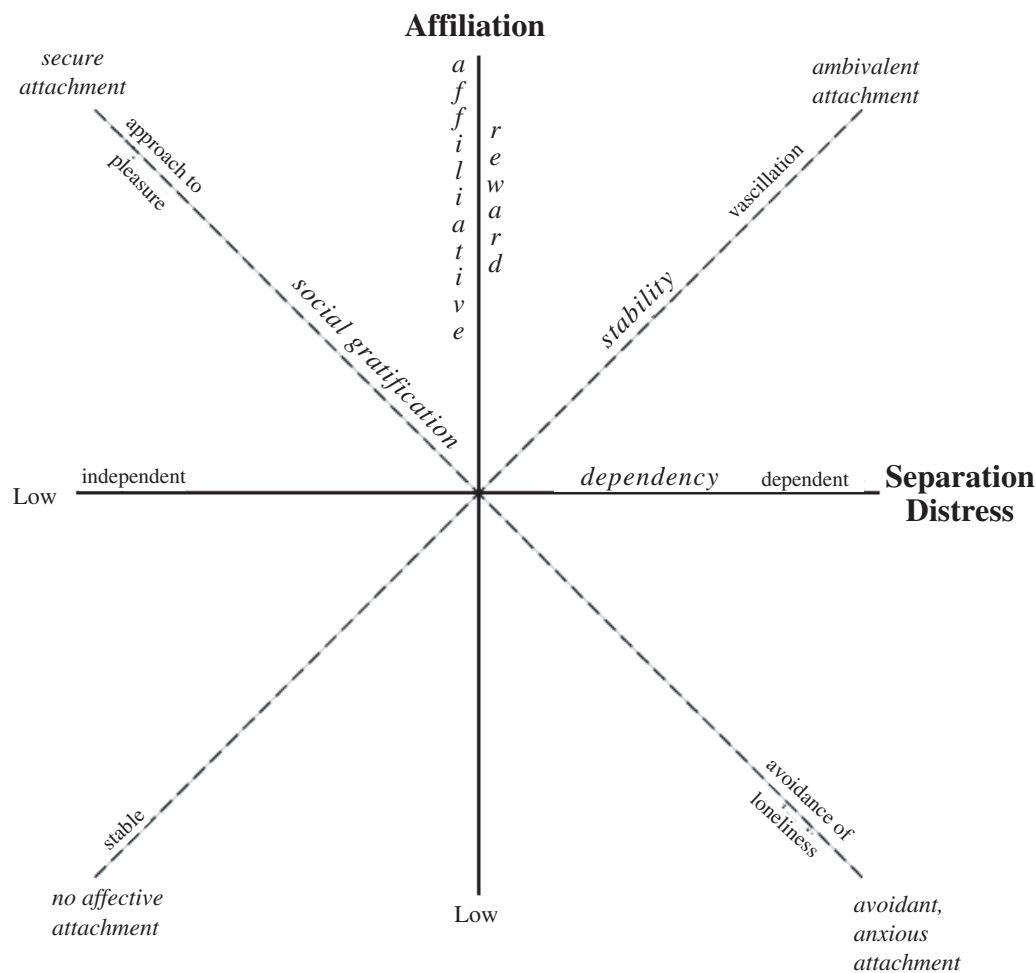

Figure R2. Interaction of the higher-order personality trait of affiliation and separation distress.

Moreover, serotonin provides a strong inhibitory feedback modulation of arousal via input to brainstem nuclei that integrate central nervous system arousal and activate autonomic nervous system activity (particularly, the medullary paragiganticocellularis nucleus) and via modulation of hippocampal-induced inhibition of cortisol reactivity at times of stress. These effects would provide a calming effect during naturally arousing social interactions, which Porges (2001) has emphasized as a facilitator of effective affiliative engagement. The elegant studies by **Netter et al.** discussed in their commentary provide a model for the type of empirical research required to better understand serotonin's effects on neurobiological and behavioral variables. In addition, their finding with COMT activity is also fascinating, and suggests that proficient removal of catecholamines from the synaptic cleft, hence limiting their effects in a timely manner, promotes affiliative bonding behavior, as indexed by Panksepp's new scale, CARE.

R7. Neural considerations

The commentary by **O'Donnell**, whose work significantly informed the neurobiological modeling in the target article, provides several important suggestions for improving our neural model of affiliative processes. It is quite clear, and

hence there is no need for us to comment further. In addition, we could not agree more, and we emphasize here that dopamine is not simply a reward signal but rather it is critical for encoding the saliency of cues that are to be associated with reward. As we stated in the target article: "variation in DA input to the NAS will modulate the strength of the contextual ensemble, and hence the capacity of the ensemble to elicit incentive motivation, positive affect, and approach behavior. *This then represents the encoding by DA of incentive salience of contextual ensembles.*" (target article, sect. 6.2.1.6, paragraph 4, emphasis in original).

References

Letters "a" and "r" appearing before authors' initials refer to target article and response, respectively.

- aan het Rot, M., Moskowitz, D. S., Pinar, G. & Young, S. N. (2004) Social behavior and mood in everyday life: The effect of tryptophan in high trait-quarrelsome individuals. Paper presented at the Meeting of the Canadian College of Neuropsychopharmacology, Kingston, Ontario, May 29–June 1, 2004 (Abstract). [SNY]
- Adolphs, R. (2003) Cognitive neuroscience of human social behavior. *Nature Reviews Neuroscience* 4:165–78. [aRAD]
- Adolphs, R., Damasio, H., Tranel, D., Cooper, G. & Damasio, A. R. (2000) A role

- for somatosensory cortices in the visual recognition of emotion as revealed by three-dimensional lesion mapping. *Journal of Neuroscience* 20:2683–90. [R-PB]
- Aggleton, J. (1992) *The amygdala: Neurobiological aspects of emotion, memory, and mental dysfunction*. Wiley-Liss. [aRAD]
- (2000) *The amygdala: A functional analysis*. Oxford University Press. [aRAD]
- Agmo, A., Barreau, S. & Lemaire, V. (1997) Social motivation in recently weaned rats is modified by opiates. *Developmental Neuroscience* 19:505–20. [aRAD]
- Agmo, A. & Berenfeld, R. (1990) Reinforcing properties of ejaculation in the male rat: Role of opioids and dopamine. *Behavioral Neuroscience* 104:177–82. [aRAD]
- Agmo, A. & Gomez, M. (1993) Sexual reinforcement is blocked by infusion of naloxone into the medial preoptic area. *Behavioral Neuroscience* 107:812–18. [aRAD]
- Agren, G., Olsson, C., Uvnas-Moberg, K. & Lundberg, T. (1997) Olfactory cues from an oxytocin-injected male rat can reduce energy less in its cagemates. *NeuroReport* 8:2551–55. [aRAD]
- Aharon, I., Etcoff, N., Ariety, D., Chabris, C., O'Connor, E. & Breiter, H. (2001) Beautiful faces have variable reward value: fMRI and behavioral evidence. *Neuron* 32:537–51. [aRAD]
- Ahmed, S., Stinus, L., Le Moal, M. & Cador, M. (1993) Controlling interindividual differences in the unconditioned response to amphetamine in the study of environment-dependent sensitization. *Behavioral Pharmacology* 4:355–64. [aRAD]
- Ahmed, S. H., Cador, M., Le Moal, M. & Stinus, L. (1995) Amphetamine-induced conditioned activity in rats: Comparison with novelty-induced activity and role of the basolateral amygdala. *Behavioral Neuroscience* 109(4):723–33. [aRAD]
- Ainsworth, M. D. S. (1991) Attachments and other affectional bonds across the life cycle. In: *Attachment across the life cycle*, ed. C. M. Parkes, J. Stevenson-Hinde & P. Marris, pp. 33–51. Routledge. [WBM]
- Alcock, J. (2001) *Animal behavior*, 7th edition. Sinauer. [SLB]
- Alexander, G., Crutcher, M. & DeLong, M. (1990) Basal ganglia-thalamocortical circuits: Parallel substrates for motor, oculomotor, "prefrontal" and "limbic" functions. In: *Progress in brain research*, vol. 85, ed. H. Uylings, C. Van Eden, J. De Bruin, M. Corner & M. Feenstra. Elsevier. [aRAD]
- Alexander, G. E. & Crutcher, M. D. (1990) Functional architecture of basal ganglia circuits: Neural substrates of parallel processing. *Trends in Neuroscience* 13:266–71. [PO]
- Aluja, A., Garcia, O. & Garcia, L. F. (2003) Relationships among extraversion, openness to experience, and sensation seeking. *Personality and Individual Differences* 35:671–80. [TARW]
- Amalric, M., Cline, E., Martinez, J., Bloom, F. & Koob, G. (1987) Rewarding properties of β -endorphin as measured by conditioned place preference. *Psychopharmacology* 91:14–19. [aRAD]
- American Psychiatric Association (1994) *Diagnostic and statistical manual of mental disorders*, 4th edition. American Psychiatric Association. [DAP]
- Annett, L., McGregor, A. & Robbins, T. (1989) The effects of ibotenic acid lesions of the nucleus accumbens on spatial learning and extinction in the rat. *Behavioural Brain Research* 31:231–42. [aRAD]
- Aosaki, T., Graybiel, A. M. & Kimura, M. (1994) Effect of nigrostriatal dopamine system on acquired neural responses in the striatum of behaving monkeys. *Science* 265(5170):412–15. [aRAD]
- Aoyagi, K., Oomura, Y. & Shimizu, N. (1992) Concurrent measurement of serotonin metabolism and single neuron activity changes in the lateral hypothalamus of freely behaving rats. *Behavioral Brain Research* 49:205–12. [aRAD]
- Apicella, P., Ljungberg, T., Scarnati, E. & Schultz, W. (1991) Responses to reward in monkey dorsal and ventral striatum. *Experimental Brain Research* 85:491–511. [aRAD]
- Argiolas, A. & Gessa, G. L. (1991). Central functions of oxytocin. *Neuroscience and Biobehavioral Reviews* 15:217–31. [aRAD]
- Ashby, C. (1996) The modulation of dopaminergic neurotransmission by other neurotransmitters. CRC Press. [aRAD]
- Ashton, M. C., Lee, K., Perugini, M., Szarota, P., de Vries, R. E., Di Blas, L., Boies, K. & De Raad, B. (2004) A six factor structure of personality descriptive adjectives: Solutions from psycholexical studies in seven languages. *Journal of Personality and Social Psychology* 86:356–66. [DJZ]
- Aston-Jones, G., Rajkowski, J., Kubiak, P., Valentino, R. & Shiptley, M. (1996) Role of the locus coeruleus in emotional activation. In: *The emotional motor system*, ed. G. Holstege, R. Bandler & C. Saper. Elsevier. [aRAD]
- Atkinson, J. W., Heyns, R. W. & Veroff, J. (1954) The effect of experimental arousal of the affiliation motive on thematic apperception. *Journal of Abnormal and Social Psychology* 49:405–10. [DSL]
- Attenburrow, M. J., Williams, C., Odontiadis, J., Reed, A., Powell, J., Cowen, P. J. & Harmer, C. J. (2003) Acute administration of nutritionally sourced tryptophan increases fear recognition. *Psychopharmacology* 169:104–07. [SNY]
- Aureli, F. (1997) Post-conflict anxiety in nonhuman primates: The mediating role of emotion in conflict resolution. *Aggressive Behavior* 23:315–28. [KI]
- Aylward, E. H., Minshew, N. J., Goldstein, G., Honeycutt, N. A., Augustine, A. M., Yates, K. O., Barta, P. E. & Pearson, G. D. (1999) MRI volumes of amygdala and hippocampus in non-mentally retarded autistic adolescents and adults. *Neurology* 53:2145–50. [R-PB]
- Azaryan, A., Coughlin, L., Buzas, B., Clock, B. & Cox, B. (1996) Effects of chronic cocaine treatment on mu- and delta-opioid receptor mRNA levels in dopaminergically innervated brain regions. *Journal of Neurochemistry* 66:443–48. [aRAD]
- Bale, T. & Dorsa, D. (1995a) Sex differences in and effects of estrogen on oxytocin receptor messenger ribonucleic acid expression on the ventromedial hypothalamus. *Endocrinology* 136:27–32. [aRAD]
- (1995b) Regulation of oxytocin receptor messenger ribonucleic acid in the ventrolateral hypothalamus by testosterone and its metabolites. *Endocrinology* 136:5135–38. [aRAD]
- Bales, K. & Carter, C. S. (2003a) Developmental exposure to oxytocin facilitates partner preferences in male prairie voles (*Microtus ochrogaster*). *Behavioral Neuroscience* 117:854–59. [CSC]
- (2003b) Sex differences and developmental effects of oxytocin on aggression and social behavior in prairie voles (*Microtus ochrogaster*). *Hormones and Behavior* (Special issue on Aggressive and Violent Behavior) 44:178–84. [CSC]
- Bales, K., Lewis-Reese, A. & Carter, C. S. (2003) Neonatal handling affects male monogamous behaviors in prairie voles (*Microtus ochrogaster*). *Developmental Psychobiology* 43:246. [CSC]
- Bales, K. L., Pfeifer, L. A. & Carter, C. S. (2004a) Sex differences and developmental effects of manipulations of oxytocin on alloparenting and anxiety in prairie voles. *Developmental Psychobiology* 44:123–31. [CSC]
- Bales, K. L., Plotsky, P. M., Young, L. J., Lim, M. M., Grotte, N. & Carter, C. S. (2004b) Neonatal manipulations of oxytocin have sexually dimorphic effects on vasopressin receptor binding in monogamous prairie voles. *Society for Neuroscience Abstracts* 758.13. [CSC]
- Bals-Kubik, R., Ableitner, A., Herz, A. & Shippenberg, T. S. (1993) Neuroanatomical sites mediating the motivational effects of opioids as mapped by the conditioned place preference paradigm in rats. *Journal of Pharmacology and Experimental Therapeutics* 264(1):489–95. [aRAD]
- Bandler, R. & Keay, K. (1996) Columnar organization in the midbrain periaqueductal gray and the integration of emotional expression. In: *The emotional motor system*, ed. G. Holstege, R. Bandler & C. Saper. Elsevier. [aRAD]
- Barbas, H. (1995) Anatomic basis of cognitive-emotional interactions in the primate prefrontal cortex. *Neuroscience and Biobehavioral Reviews* 19:499–510. [aRAD]
- Barlow, D. H. (2002) *Anxiety and its disorders: The nature and treatment of anxiety and panic*, 2nd edition. Guilford Press. [aRAD]
- Bar-On, B. (1994) Meditations on national identity. *Hypatia Spring* 9(2):40–62. [NNP]
- Baron-Cohen, S., Leslie, A. M. & Frith, U. (1985) Does the autistic child have a "theory of mind"? *Cognition* 21:37–46. [R-PB]
- Barr, G. & Jones, K. (1994) Opiate withdrawal in the infant. *Neurotoxicology and Teratology* 16:219–25. [JES]
- Bartels, A. & Zeki, S. (2004) The neural correlates of maternal and romantic love. *NeuroImage* 21(3):1155–66. [PO, JP, JES, AT]
- Bartholomew, K. & Horowitz, L. M. (1991) Attachment styles among young adults: A test of a four-category model. *Journal of Personality and Social Psychology* 61:226–44. [AT]
- Bauman, M. & Kemper, T. (1985) Histo-anatomic observations of the brain in early infantile autism. *Neurology* 35:866–74. [R-PB]
- Baumeister, A., Hurry, M., Curtis, W., Chaney, T., Wof, E. & Leoni, R. (1993) The antinociceptive and motivational effects of intranasal injection of opioid agonists. *Neuropharmacology* 32:1299–1303. [aRAD]
- Baxter, M. G. & Murray, E. A. (2002) The amygdala and reward. *Nature Reviews Neuroscience* 3:563–74. [aRAD]
- Beauchamp, G. K. & Yamazaki, K. (1997) HLA and mate selection in humans: Commentary. *American Journal of Human Genetics* 61:494–96. [aRAD]
- Bechara, A., Damasio, H., Tranel, D. & Damasio, A. (1997) Deciding advantageously before knowing the advantageous strategy. *Science* 275:1293–95. [aRAD]
- Bechara, A., Tranel, D., Damasio, H., Adolphs, R., Rockland, C. & Damasio, A. (1995) Double dissociation of conditioning and declarative knowledge relative to the amygdala and hippocampus in humans. *Science* 269:1115–18. [aRAD]
- Begg, A., Wickens, J. & Arbuthnott, G. (1993) A long-lasting effect of dopamine on synaptic transmission in the corticostriatal pathway, in vitro. *Proceedings of the 11th International Australasian Winter Conference on Brain Research. International Journal of Neuroscience* 17:201–12. [aRAD]
- Belknap, J. K., Mogil, J., Helms, M., Richards, S., O'Toole, L., Beergeson, S. &

- Buck, K. (1995) Localization to chromosome 10 of a locus influencing morphine analgesia in crosses derived from C57BL/6 and DBA/2 strains. *Life Sciences* 57:PL117–28. [aRAD]
- Bennett, M. R. & Hacker, P. M. S. (2003) *Philosophical foundations of neuroscience*. Blackwell. [JP]
- Berman, C. M. (1982) The ontogeny of social relationships with group companions among free ranging infant rhesus monkeys *Macaca mulatta* 1. Social networks and differentiation. *Animal Behaviour* 30(1):149–62. [TARW]
- Bernstein, I. S., Judge, P. G. & Ruehlmann, T. E. (1993) Kinship, association, and social relationships in rhesus monkeys (*Macaca mulatta*). *American Journal of Primatology* 31:41–53. [KI]
- Berretta, N. & Jones, R. S. (1996) Tonic facilitation of glutamate release by presynaptic N-methyl-D-aspartate autoreceptors in the entorhinal cortex. *Neuroscience* 75(2):339–44. [aRAD]
- Berrettini, W. H., Alexander, R. C., Ferraro, T. N. & Vogel, W. (1994a) A study of oral morphine preference in inbred mouse strains. *Psychiatric Genetics* 4:81–86. [aRAD]
- Berrettini, W. H., Ferraro, T. N., Alexander, R. C., Buchberg, A. M. & Vogel, W. H. (1994b) Quantitative trait loci mapping of three loci controlling morphine preference using inbred mouse strains. *Nature Genetics* 7:54–58. [aRAD]
- Berrettini, W. H., Hoehe, M., Ferraro, T. N., DeMaria, P. & Gotthel, E. (1997) Human mu opioid receptor gene polymorphisms and vulnerability to substance abuse. *Addiction and Biology* 2:303–08. [aRAD]
- Berridge, K. C. (1999) Pleasure, pain, desire, and dread: Hidden core processes of emotion. In: *Well-being: The foundations of hedonic psychology*, ed. D. Kahneman, E. Diener & N. Schwarz. Russell Sage. [aRAD, LDK]
- (2004) Pleasure, unfelt affect, and irrational desire. In: *Feelings and emotions: The Amsterdam symposium*, ed. A. S. R. Manstead, N. Frijda & A. Fischer. Cambridge University Press. [LDK]
- Berthoz, S., Armony, J. L., Blair, R. J. R. & Dolan, R. J. (2002) An fMRI study of intentional and unintentional (embarrassing) violations of social norms. *Brain* 125:1696–1708. [DJZ]
- Bindra, D. (1978) How adaptive behavior is produced: A perceptual-motivation alternative to response reinforcement. *Behavioral and Brain Sciences* 1:41–91. [aRAD]
- Bissiere, S., Humeau, Y. & Luthi, A. (2003) Dopamine gates LTP induction in lateral amygdala by suppressing feedforward inhibition. *Nature Neuroscience* 6:587–92. [aRAD]
- Blackburn, J. R., Phillips, A. G., Jakubovic, A. & Fibiger, H. C. (1989) Dopamine and preparatory behavior: II. A neurochemical analysis. *Behavioral Neuroscience* 103:15–23. [aRAD]
- Blake, M., Stein, E. & Czech, D. (1987) Drinking-induced alterations in reward pathways: An in vivo autoradiographic analysis. *Brain Research* 413:111–19. [aRAD]
- Blass, E. M. (1992) The ontogeny of motivation: Opioid bases of energy conservation and lasting affective change in rat and human infants. *Current Directions in Psychological Science* 1(4):116–20. [aRAD]
- Blass, E. M., Shide, D. J., Zaw-Man, C. & Sorrentino, J. (1995) Mother as shield: Differential effects of contact and nursing on pain responsivity in infant rats – Evidence for nonopioid mediation. *Behavioral Neuroscience* 109:342–53. [JES]
- Block, N. (1995) On a confusion about a function of consciousness. *Behavioral and Brain Sciences* 18:227–47. Updated in *The nature of consciousness: Philosophical debates*, ed. N. Block, O. Flanagan & G. Güzeldere. MIT Press, 1997. [LDK]
- (1997) Biology versus computation in the study of consciousness. (Response to Continuing Commentary on Block 1995). *Behavioral and Brain Sciences* 20:159–65. [LDK]
- (2002) Some concepts of consciousness. In: *Philosophy of mind: Classical and contemporary readings*, ed. D. Chalmers. Oxford University Press. [LDK]
- Blum, K., Braverman, E. R., Holder, J. R., Lubar, J. F., Monastra, V. J., Miller, D., Lubar, J. O., Chen, T. J. & Comings, D. E. (2000) Reward deficiency syndrome: A biogenetic model for the diagnosis and treatment of impulsive, addictive, and compulsive behaviors. *Journal of Psychoactive Drugs* 32(Suppl. i–iv):1–112. [AT]
- Bodkin, J. L., Zornberg, G. L., Lucas, S. E. & Cole, J. O. (1995) Buprenorphine treatment of refractory depression. *Journal of Clinical Psychopharmacology* 16:49–57. [JP]
- Bond, C., LaForge, K. S., Tian, M., Melia, D., Zhang, S., Borg, L., Gong, J., Schluger, J., Strong, J. A., Leal, S. M., Tischfield, J. A., Kreek, M. J. & Yu, L. (1998) Single-nucleotide polymorphism in the human mu opioid receptor gene alters β -endorphin binding and activity: Possible implications for opiate addiction. *Proceedings of the National Academy of Sciences USA* 95:9608–13. [aRAD]
- Bouyer, J., Miller, R. & Pickel, V. (1984) Ultrastructural relation between cortical efferents and terminals containing enkephalin-like immunoreactivity in rat neostriatum. *Regulatory Peptides* 8:105–15. [aRAD]
- Bowman, E., Aigner, T. & Richmond, B. (1996) Neural signals in the monkey ventral striatum related to motivation for juice and cocaine rewards. *Journal of Neurophysiology* 75:1061–73. [aRAD]
- Bozarth, M. (1987) Ventral tegmental reward system. In: *Brain reward systems and abuse*, ed. J. Engel & L. Oreland. Raven Press. [aRAD]
- (1994) Opiate reinforcement processes: Re-assembling multiple mechanisms. *Addiction* 89:1425–34. [aRAD]
- Breiter, H., Aharon, I., Kahneman, D., Dale, A. & Shizgal, P. (2001) Functional imaging of neural responses to expectancy and experience of monetary gains and losses. *Neuron* 30:619–39. [aRAD]
- Breiter, H. C., Gollub, R. L., Weisskoff, R. M., Kennedy, D. N., Makris, N., Berke, J. D., Goodman, J. M., Kantor, H. L., Gastfriend, D. R., Riorden, J. P., Mathew, R. T., Rosen, B. R. & Hyman, S. E. (1997) Acute effects of cocaine on human brain activity and emotion. *Neuron* 19:591–611. [aRAD]
- Bremner, J. D., Innis, R. B., Salomon, R. M., Staib, L. H., Ng, C. K., Miller, H. L., Bronen, R. A., Krystal, J. H., Duncan, J., Rich, D. P., Lawrence, H., Malison, R., Dey, H., Soufer, R. & Charney, D. S. (1997) Positron emission tomography measurement of cerebral metabolic correlates of tryptophan depletion-induced depressive relapse. *Archives of General Psychiatry* 54:364–74. [DAP]
- Bremner, J. D., Vythilingam, M., Vermetten, E., Nazeer, A., Adil, J., Khan, S., Staib, L. H. & Charney, D. S. (2002) Reduced volume of orbitofrontal cortex in major depression. *Biological Psychiatry* 51:273–79. [DAP]
- Bridges, R. & Ronsheim, P. (1987) Immunoreactive beta-endorphin concentrations in brain and plasma during pregnancy in rats. *Neuroendocrinology* 45:381–88. [aRAD]
- Bridges, R. S. & Grimm, C. T. (1982) Reversal of morphine disruption of maternal behavior by concurrent treatment with the opiate antagonist naloxone. *Science* 218:166–68. [JES]
- Brothers, L. & Ring, B. (1992) A neuroethological framework for the representation of minds. *Journal of Cognitive Neuroscience* 4(2):107–18. [aRAD]
- Brown, C. H., Russell, J. A. & Leng, G. (2000) Opioid modulation of magnocellular neurosecretory cell activity. *Neuroscience Research* 36:97–120. [aRAD]
- Brown, J., Bullock, D. & Crossberg, S. (1999) How the basal ganglia use parallel excitatory and inhibitory learning pathways to selectively respond to unexpected rewarding cues. *Journal of Neuroscience* 19:10502–11. [DSL]
- Brown, K. W. & Moskowitz, D. S. (1998) Dynamic stability of behavior: The rhythms of our interpersonal lives. *Journal of Personality* 66:105–34. [SNY]
- Brown, S. L. (1999) *The origins of investment: Testing a theory of close relationships*. Dissertation Abstracts, Arizona State University. [SLB]
- Brown, S. L. & Brown, R. M. (in press) Selective investment theory: Recasting the functional significance of close relationships. *Psychological Inquiry* [SLB]
- Buettner, C. (2004) *Parties, police and pandemonium: An exploratory study of mixed-issue campus disturbances*. Doctoral dissertation, Ohio State University. (Dissertation Abstracts International). [MG]
- Buss, A. & Plomin, R. (1984) *Temperament: Early developing personality traits*. Erlbaum. [aRAD]
- Buss, D. (1989) Sex differences in human mate preferences: Evolutionary hypotheses tested in 37 cultures. *Behavioral and Brain Sciences* 12:1–14. [aRAD]
- Byrne, G. & Suomi, S. J. (1998) Relationship of early infant state measures to behavior over the first year of life in the tufted capuchin monkey (*Cebus apella*). *American Journal of Primatology* 44(1):43–56. [aRAD]
- Byrnes, E. & Bridges, R. (2000) Endogenous opioid facilitation of maternal memory in rats. *Behavioral Neuroscience* 114:797–804. [aRAD]
- Cacioppo, J., Berston, G., Adolphs, R., Carter, C., Davidson, R., McClintock, M., McEwen, B., Meaney, M., Schacter, D. & Sternberg, E., eds. (2002) *Foundations in social neuroscience*. MIT Press. [aRAD]
- Cador, M., Taylor, J. & Robbins, T. (1991) Potentiation of the effects of reward-related stimuli by dopaminergic-dependent mechanisms in the nucleus accumbens. *Psychopharmacology* 104:377–85. [aRAD]
- Cahill, L. & McGaugh, J. (1990) Amygdaloid complex lesions differentially affect retention of tasks using appetitive and aversive reinforcement. *Behavioral Neuroscience* 104:532–43. [aRAD]
- (1998) Mechanisms of emotional arousal and lasting declarative memory. *Trends in Neuroscience* 21:294–99. [aRAD]
- Caine, S. & Koob, G. (1993) Modulation of cocaine self-administration in the rat through D-3 dopamine receptors. *Science* 260:1814–16. [aRAD]
- Calabresi, P., Pisani, A., Mercuri, N. B., & Bernardi, G. (1996) The corticostriatal projection: From synaptic plasticity to dysfunctions of the basal ganglia. *Trends in the Neurosciences* 19(1):19–24. [aRAD]
- Calabresi, P., Saiardi, A., Pisani, A., Baik, J. H., Centonze, D., Mercuri, N. B., Bernardi, G. & Borrelli, E. (1997) Abnormal synaptic plasticity in the striatum of mice lacking dopamine D2 receptors. *Journal of Neuroscience* 17(12):4536–44. [aRAD]
- Calamandrei, G. & Keverne, E. B. (1994) Differential expression of fos protein in

- the brain of female mice dependent on pup sensory cues and maternal experience. *Behavioral Neuroscience* 108(1):113–20. [aRAD]
- Caldwell, J., Brooks, P., Jirkowski, G., Barakat, A., Lund, P. & Pedersen, C. (1989) Estrogen alters oxytocin mRNA levels in the preoptic area. *Journal of Neuroendocrinology* 1:273–78. [aRAD]
- Caldwell, J., Walker, C., Pedersen, C., Barakat, A. & Mason, G. (1994) Estrogen increases affinity of oxytocin receptors in the medial preoptic area anterior hypothalamus. *Peptides* 15:1079–84. [aRAD]
- Callahan, P., Baumann, M. & Rabil, J. (1996) Inhibition of tuberoinfundibular dopaminergic neural activity during suckling: Involvement of mu and kappa opiate receptor subtypes. *Journal of Neuroendocrinology* 8:771–76. [aRAD]
- Capitatio, J. P. (1984) Early experience and social processes in rhesus macaques: I. Dyadic social interaction. *Journal of Comparative Psychology* 98:35–44. [TARW]
- (1985) Early experience and social processes in rhesus macaques (*Macaca mulatta*): II. Complex social interaction. *Journal of Comparative Psychology* 99(2):133–44. [TARW]
- (1986) Behavioral pathology. In: *Comparative primate biology, vol. 2A*, ed. G. Mitchell & J. Erwin, pp. 411–454. Alan R. Liss. [TARW]
- (1999) Personality dimensions in adult male rhesus macaques: Prediction of behaviors across time and situation. *American Journal of Primatology* 47:299–320. [arRAD, TARW]
- Capitatio, J. P., Mendoza, S. P. & Lerche, N. W. (1998) Individual differences in peripheral blood immunological and hormonal measures in adult male rhesus macaques (*Macaca mulatta*): Evidence for temporal and situational consistency. *American Journal of Primatology* 44(1):29–41. [arRAD]
- Carlezon, W., Boundy, V., Haile, C., Lane, S., Kalb, R., Neve, R. & Nestler, E. (1997) Sensitization to morphine induced by viral-mediated gene transfer. *Science* 277:812–14. [aRAD]
- Carlezon, W., Haile, C., Coopersmith, R., Hayashi, Y., Malinow, R., Neve, R. & Nestler, E. (2000) Distinct sites of opiate reward and aversion within the midbrain identified using a herpes simplex virus vector expressing GluR1. *Journal of Neuroscience* 20(RC62):1–5. [aRAD]
- Carlezon, W. & Wise, R. (1996) Rewarding actions of phencyclidine and related drugs in nucleus accumbens shell and frontal cortex. *Journal of Neuroscience* 16:3112–22. [aRAD]
- Carmichael, S. & Price, J. (1995) Limbic connections of the orbital and medial prefrontal cortex in macaque monkeys. *Journal of Comparative Neurology* 363:615–41. [aRAD]
- Carr, D. & Sesack, S. (2000) Projections from the rat prefrontal cortex to the ventral tegmental area: Target specificity in the synaptic associations with mesoaccumbens and mesocortical neurons. *Journal of Neuroscience* 20:3864–73. [aRAD]
- Carr, G., Fibiger, H. & Phillips, A. (1989) Conditioned place preference as a measure of drug reward. In: *The neuropharmacological basis of reward*, ed. J. Libman & S. Cooper. Oxford University Press. [aRAD]
- Carroll, K., Ball, S., Nich, C., O'Connor, P., Eagan, D., Frankforter, T., Triffleman, E., Shi, J. & Rounsaville, B. (2001) Targeting behavioral therapies to enhance naltrexone treatment of opioid dependence. *Archives of General Psychiatry* 58:755–61. [aRAD]
- Carter, C. S. (1992) Oxytocin and sexual behavior. *Neuroscience and Biobehavioral Reviews* 16:131–44. [aRAD]
- (1998) Neuroendocrine perspectives on social attachment and love. *Psychoneuroendocrinology* 23(8):779–818. [SLB, CSC, aRAD]
- (2003) Developmental consequences of oxytocin. *Physiology and Behavior* 79:383–97. [CSC]
- Carter, C. S. & Keever, E. B. (2002) The neurobiology of social affiliation and pair bonding. In: *Hormones, Brain, and Behavior*, ed. D. Pfaff. Academic Press. [CSC]
- Carter, C. S., DeVries, A. C. & Getz, L. L. (1995) Physiological substrates of mammalian monogamy: The prairie vole model. *Neuroscience and Biobehavioral Reviews* 19(2):303–14. [CSC, aRAD]
- Carter, S., Lederhendler, I. & Kirkpatrick, B. (1997) *The integrative neurobiology of affiliation, vol. 807*. New York Academy of Sciences. [aRAD]
- Cassidy, J. (1999) The nature of the child's ties. In: *Handbook of attachment: Theory, research, and clinical applications*, ed. J. Cassidy & P. R. Shaver. Guilford Press. [aRAD]
- Cassidy, J. & Shaver, P., eds. (1999) *Handbook of attachment: Theory, research, and clinical applications*. Guilford Press. [NNP]
- Cattell, R., Eber, H. & Tatsuoka, M. (1980) *Handbook for the Sixteen Personality Questionnaire (16PF)*. Institute for Personality and Ability Testing. [aRAD]
- Cepeda, C. & Levine, M. S. (1998) Dopamine and N-methyl-D-aspartate receptor interactions in the neostriatum. *Developmental Neuroscience* 20: 1–18. [PO]
- Champoux, M., Higley, J. D. & Suomi, S. J. (1997) Behavioral and physical characteristics of Indian and Chinese-Indian hybrid rhesus macaque infants. *Developmental Psychobiology* 31(1):49–63. [arRAD]
- Chen, L. & Huang, L.-Y. M. (1991) Sustained potentiation of NMDA receptor-mediated glutamate responses through activation of protein kinase C by a μ opioid. *Neuron* 7:319–26. [aRAD]
- Cho, M. M., DeVries, C., Williams, J. R. & Carter, C. S. (1999) The effects of oxytocin and vasopressin on partner preferences in male and female prairie voles (*Microtus ochrogaster*). *Behavioral Neuroscience* 113:1071–79. [CSC, DSL]
- Chowdhury, M. & Fillenz, M. (1991) Presynaptic adenosine A2 and N-methyl-D-aspartate receptors regulate dopamine synthesis in rat striatal synaptosomes. *Journal of Neurochemistry* 56:1783–88. [aRAD]
- Christie, M. J., Summers, R. J., Stephenson, J. A., Cook, C. J. & Beart, P. M. (1987) Excitatory amino acid projections to the nucleus accumbens septi in the rat: A retrograde transport study utilizing D³H]aspartate and [³H]GABA. *Neuroscience* 22(2):425–39. [aRAD]
- Church, A. T. (1994) Relating the Tellegen and five-factor models of personality structure. *Journal of Personality and Social Psychology* 67:898–909. [aRAD]
- Church, T. & Burke, P. (1994) Exploratory and confirmatory tests of the big five and Tellegen's three- and four-dimensional models. *Journal of Personality and Social Psychology* 66:93–114. [aRAD]
- Churchill, L., Roques, B. P. & Kalivas, P. W. (1995) Dopamine depletion augments endogenous opioid-induced locomotion in the nucleus accumbens using both μ 1 and δ opioid receptors. *Psychopharmacology* 120: 347–55. [aRAD]
- Cismareco, A. S. & Montagner, H. (1990) Mothers' discrimination of their neonates' cry in relation to cry acoustics: The first week of life. *Early Child Development and Care* 65:3–11. [aRAD]
- Clelland, C., Nakamura, Y., Howland, E., Morgan, N., Edwards, K. & Backonja, M. (1996) Effects of oral morphine on cold pressor tolerance time and neuropsychological performance. *Neuropsychopharmacology* 15:252–62. [aRAD]
- Cloninger, C. R. (1986) A unified biosocial theory of personality and its role in the development of anxiety states. *Psychiatric Developments* 3:167–226. [aRAD, MRM]
- Cloninger, C. R., Przybeck, R. & Svrakic, D. (1991) The Tridimensional Personality Questionnaire. U.S. normative data. *Psychological Reports* 69:1047–57. [PN]
- Cloninger, C. R., Svrakic, D. & Przybeck, T. (1993) A psychobiological model of temperament and character. *Archives of General Psychiatry* 50:975–90. [aRAD]
- Coccaro, E. F. & Kavoussi, R. J. (1997) Fluoxetine and impulsive aggressive behavior in personality-disordered subjects. *Archives of General Psychiatry* 54:1081–88. [SNY]
- Collins, P. & Depue, R. (1992) A neurobehavioral systems approach to developmental psychopathology: Implications for disorders of affect. In: *Developmental psychopathology, vol. 4*, ed. D. Cicchetti. University of Rochester Press. [aRAD]
- Colman, H., Nabekura, J. & Lichtman, J. (1997) Alterations in synaptic strength preceding axon withdrawal. *Science* 275:356–61. [aRAD]
- Colvin, J. & Tissier, G. (1985) Affiliation and reciprocity in sibling and peer relationships among free-ranging immature male rhesus monkeys *Macaca mulatta*. *Animal Behaviour* 33(3):959–77. [TARW]
- Comoli, E., Coizet, V., Boyes, J., Bolam, J. P., Canteras, N. S., Quirk, R. H., Overton, P. G. & Regrave, P. (2003) A direct projection from superior colliculus to substantia nigra for detecting salient visual events. *Nature Neuroscience* 6:974–80. [aRAD]
- Comrey, A. (1970) *Manual for the Comrey Personality Scales*. Educational and Industrial Testing Service. [aRAD]
- Conger, R., Ge, S., Elder, G., Lorenz, F. & Simons, R. (1994) Economic stress, coercive family process and developmental problems of adolescents. *Child Development* 65:541–61. [aRAD]
- Cooper, M. A. & Bernstein, I. S. (2000) Social grooming in assamese macaques (*Macaca assamensis*). *American Journal of Primatology* 50(1):77–85. [TARW]
- Corrigall, W. & Vaccarino, F. (1988) Antagonist treatment in nucleus accumbens or periaqueductal grey affects heroin self-administration. *Pharmacology Biochemistry and Behavior* 30:433–50. [aRAD]
- Corter, C. & Fleming, A. (1995) Psychobiology of maternal behavior in human beings. In: *Handbook of parenting*, ed. M. Bornstein. Erlbaum. [aRAD]
- Costa, P. & McCrae, R. (1985) *The NEO Personality Inventory manual*. Psychological Assessment Resources. [aRAD]
- (1989) *The NEO-PI/NEO-FFI manual supplement*. Psychological Assessment Resources. [aRAD]
- (1994) *Revised NEO Personality Inventory (NEO-PI-R) and NEO Five-Factor Inventory (NEO-FFI) professional manual*. Psychological Assessment Resources. [aRAD]
- Costa, P. T. Jr. & McCrae, R. R. (1997) Stability and change in personality assessment: The revised NEO personality inventory in the year 2000. *Journal of Personality Assessment* 68:86–94. [MRM]
- Courchesne, E., Karns, C. M., Davies, H. R., Ziccardi, R., Carper, R. A., Tigue, Z. D., Chisum, H. J., Moses, P., Pierce, K., Lord, C., Lincoln, A. J., Pizzo, S.,

- Schreibman, L., Haas, R. H., Akshoomoff, N. A. & Courchesne, R. Y. (2001) Unusual brain growth patterns in early life in patients with autistic disorder. *Neurology* 57:245–54. [R-PB]
- Crews, D. (1998) The evolutionary antecedents to love. *Psychoneuroendocrinology* 23:751–64. [aRAD]
- Critchley, H. C., Wiens, S., Rotstein, P., Ohman, A. & Dolan, R. J. (2004) Neural systems supporting interoceptive awareness. *Nature Neuroscience* 7:189–95. [rRAD]
- Crowley, J. J., Oslin, D. W., Patkar, A. A., Gotthel, E., DeMaria, P. A. Jr., O'Brien, C. P., Berrettini, W. H. & Grice, D. E. (2003) A genetic association study of the mu opioid receptor and severe opioid dependence. *Psychiatric Genetics* 13:169–73. [MRM]
- Cruz, M. & Del Cerro, R. (1998) Role of the vomeronasal input in maternal behavior. *Psychoneuroendocrinology* 23(8):905–26. [aRAD]
- Csiffary, A., Ruttner, Z., Toth, Z. & Palkovits, M. (1992) Oxytocin nerve fibers innervate β -endorphin neurons in the arcuate nucleus of the rat hypothalamus. *Neuroendocrinology* 56:429–35. [aRAD]
- Csikszentmihalyi, M. & Larson, R. (1987) Validity and reliability of the experience sampling method. *Journal of Nervous and Mental Diseases* 175:526–36. [SNY]
- Cunningham, S. & Kelley, A. (1992) Opiate infusion into nucleus accumbens: Contrasting effects on motor activity and responding for conditioned reward. *Brain Research* 588:104–14. [aRAD]
- Curran, F. & Watson, S. (1995) Dopamine receptor mRNA expression patterns by opioid peptide cells in the nucleus accumbens of the rat: A double in situ hybridization study. *Journal of Comparative Neurology* 361:57–76. [aRAD]
- da Costa, A., de la Riva, C., Guevara-Guzman, R. & Kendrick, K. (1999) C-fos and c-jun in the paraventricular nucleus play a role in regulating peptide gene expression, oxytocin and glutamate release, and maternal behaviour. *European Journal of Neuroscience* 11:2199–10. [aRAD]
- Dahlin, S., Hu, X.-T., Xue, C.-J. & Wolf, M. (1994) Lesions of prefrontal cortex amygdala, but not fimbria for fornix, prevent sensitization of amphetamine-stimulated horizontal locomotor activity. *Abstracts of the Society for Neuroscience* 20:1621. [aRAD]
- Damasio, A. R. (1994) *Descartes' error: Emotion, reason, and the human brain*. Grosset/Putnam. [aRAD]
- (1999) *The feeling of what happens: Body and emotion in the making of consciousness*. Harcourt. [aRAD, LDK]
- (2003) *Looking for Spinoza: Joy, sorrow, and the feeling brain*. Harcourt. [LDK]
- D'Amato, F. R. & Pavone, F. (1993) Endogenous opioids: A proximate reward mechanism for kin selection? *Behavioral and Neural Biology* 60:79–83. [aRAD]
- (1995) Reunion of separated sibling mice: Neurobiological and behavioral aspects. *Behavioral Neurology and Biology* 65:9–16. [aRAD]
- Damsma, G., Pfaus, J., Wenkstern, D., Phillips, A. & Fibiger, H. (1992) Sexual behavior increases dopamine transmission in the nucleus accumbens and striatum of male rats: Comparison with novelty and locomotion. *Behavioral Neuroscience* 106:181–91. [aRAD]
- Dantzer, R., Bluthé, R., Koob, G. & Le Moal, M. (1987) Modulation of social memory in male rats by neurohypophysial peptides. *Psychopharmacology* 91:363–68. [aRAD]
- Dantzer, R., Koob, G., Bluthé, R. & Le Moal, M. (1988) Septal vasopressin modulates social memory in male rats. *Brain Research* 457:143–47. [aRAD]
- Darwin, C. (1860) *On the origin of species by means of natural selection, or, The preservation of favoured races in the struggle for life*. J. Murray. [MG]
- David, V. & Cazala, P. (2000) Anatomical and pharmacological specificity of the rewarding effect elicited by microinjections of morphine into the nucleus accumbens of mice. *Psychopharmacology* 150:24–34. [aRAD]
- Davidson, R. J., Pizzagalli, D., Nitschke, J. B. & Putnam, K. (2002) Depression: Perspectives from affective neuroscience. *Annual Review of Psychology* 53:545–74. [DAP]
- Davis, K. L., Panksepp, J. & Normansell, L. (2003) The affective neuroscience personality scales: Normative data and implications. *Neuro-Psychoanalysis* 5:57–69. [PN, JP]
- Davis, M. (1992) The role of the amygdala in conditioned fear. In: *The amygdala: Neurological aspects of emotion, memory, and mental dysfunction*, ed. J. Aggleton. Wiley. [aRAD]
- Davis, M. & Shi, C. (1999) The extended amygdala: Are the central nucleus of the amygdala and the bed nucleus of the stria terminalis differentially involved in fear versus anxiety. *Annals of the New York Academy of Sciences* 877:281–91. [aRAD]
- Davis, M., Walker, D. & Lee, Y. (1997) Roles of the amygdala and bed nucleus of the stria terminalis in fear and anxiety measured with the acoustic startle reflex. *Annals of the New York Academy of Sciences* 821:305–31. [aRAD]
- Davis, P. Zhang, S. & Bandler, R. (1996) Midbrain and medullary regulation of respiration and vocalization. In: *The emotional motor system*, ed. G. Holstege, R. Bandler & C. Saper. Elsevier. [aRAD]
- Dawkins, R. (1976) *The selfish gene*. Oxford University Press. [MG]
- Dawson, G., Ashman, S. B., Panagiotides, H., Hessel, D., Self, J., Yamada, E. & Embry, L. (2003) Preschool outcomes of children of depressed mothers: Role of maternal behavior, contextual risk, and children's brain activity. *Child Development* 74:1158–75. [DAP]
- Dawson, G., Frey, K., Panagiotides, H., Osterling, J. & Hessel, D. (1997a) Infants of depressed mothers exhibit atypical frontal brain activity: A replication and extension of previous findings. *Journal of Child Psychology and Psychiatry and Allied Disciplines* 38:179–86. [DAP]
- Dawson, G., Frey, K., Panagiotides, H., Yamada, E., Hessel, D. & Osterling, J. (1999) Infants of depressed mothers exhibit atypical frontal electrical brain activity during interactions with mother and with a familiar, nondepressed adult. *Child Development* 70:1058–66. [DAP]
- Dawson, G., Panagiotides, H., Klinger, L. G. & Spieker, S. (1997b) Infants of depressed and nondepressed mothers exhibit differences in frontal brain electrical activity during the expression of negative emotions. *Developmental Psychology* 33:650–56. [DAP]
- de Kloet, E., Voorhuis, E., Boschma, Y. & Elands, J. (1986) Estradiol modulates density of putative "oxytocin receptors" in discrete brain regions. *Neuroendocrinology* 44:415–21. [aRAD]
- de Olmos, J. & Heimer, L. (1999) The concepts of the ventral striatopallidum system and extended amygdala. In: *Advancing from the ventral striatum to the extended amygdala*, ed. J. F. McGinty. *Annals of the New York Academy of Sciences* 877:71–90. [aRAD]
- de Waal, F. B. M. (1996) Macaque social culture: Development and perpetuation of affiliative networks. *Journal of Comparative Psychology* 110(2):147–54. [TARW]
- (2000) Primates – A natural heritage of conflict resolution. *Science* 289:586–90. [KI]
- DeFonseca, F., Rubio, P., Martin-Calderon, J., Barak-Caine, S., Koob, G. & Navarro, M. (1995) The dopamine receptor agonist 7-OH-DPAT modulates the acquisition and expression of morphine-induced place preference. *European Journal of Pharmacology* 274:47–55. [aRAD]
- Dellmann-Jenkins, M., Bernard-Paolucci, T. S. & Ruching, B. (1994) Does distance make the heart grow fonder? A comparison of college students in long-distance and geographically close dating relationships. *College Student Journal* 28(2):212–19. [aRAD]
- Depue, R. A. (1995) Neurobiological factors in personality and depression. *European Journal of Personality* 9:413–39. [PN]
- Depue, R. A. & Collins, P. F. (1999) Neurobiology of the structure of personality: Dopamine, facilitation of incentive motivation, and extraversion. *Behavioral and Brain Sciences* 22:491–569. [aRAD, MRM, PN, MZ]
- Depue, R. A. & Iacono, W. (1989) Neurobehavioral aspects of affective disorders. *Annual Review of Psychology* 40:457–92. [rRAD]
- Depue, R. A. & Lenzenweger, M. F. (in press) A multidimensional, neurobehavioral model of personality disorders. In: *Personality and psychopathology*, ed. R. Krueger & L. Tackett. Guilford Press. [rRAD]
- (2005) A neurobehavioral dimensional model of personality disturbance. In: *Major theories of personality disorder*, ed. M. F. Lenzenweger & J. Clarkin, pp. 391–454. Guilford Press. [rRAD]
- (2001) Personality disorders as emergent phenotypes arising from interacting neurobehavioral systems underlying personality traits. In: *Handbook of personality disorders*, ed. W. J. Livesly. Guilford. [PN]
- Depue, R. A. & Morrone-Strupinsky, J. (under review) On the nature of extraversion: Dopamine facilitation of context-reward associative processes. [rRAD]
- Depue, R. A., Luciana, M., Arbisi, P., Collins, P. & Leon, A. (1994) Dopamine and the structure of personality: Relation of agonist-induced dopamine D2 activity to positive emotionality. *Journal of Personality and Social Psychology* 67:485–98. [rRAD, PN]
- Depue, R. A. & Spoont, M. (1986) Conceptualizing a serotonin trait: A behavioral dimension of constraint. *Annals of the New York Academy of Sciences* 487:47–62. [aRAD]
- Deutch, A., Bourdelais, A. & Zahm, D. (1993) The nucleus accumbens core and shell: Accumbal compartments and their functional attributes. In: *Limbic motor circuits and neuropsychiatry*, ed. P. Kalivas & C. Barnes. CRC Press. [aRAD]
- DeVries, A. C., DeVries, M. B., Taymans, S. E. & Carter, C. S. (1996) The effects of stress on social preferences are sexually dimorphic in prairie voles. *Proceedings of the National Academy of Sciences USA* 93:11980–84. [CSC]
- DeWaele, J., Kianmaa, K. & Gianoulakis, C. (1994) Spontaneous and thanol-stimulated in vitro release of β -endorphin by the hypothalamus of AA and ANA rats. *Alcoholism: Clinical and Experimental Research* 18:1468–73. [aRAD]
- (1995) Distribution of the μ and δ opioid binding sites in the brain of the

- alcohol-preferring AA and alcohol-avoiding ANA lines of rats. *Journal of Pharmacology and Experimental Therapeutics* 275:518–27. [aRAD]
- Di Chiara, G. (1995) The role of dopamine in drug abuse viewed from the perspective of its role in motivation. *Drug and Alcohol Dependence* 38:95–137. [aRAD]
- Di Chiara, G. & North, R. A. (1992) Neurobiology of opiate abuse. *Trends in the Physiological Sciences* 13:185–93. [aRAD]
- Diego, M. A., Field, T., Hernandez-Reif, M., Cullen, C., Schanberg, S. & Kuhn, C. (2004) Prepartum, postpartum, and chronic depression effects on newborns. *Psychiatry* 67:63–80. [DAP]
- Digman, J. (1990) Personality structure: Emergence of the five-factor model. *Annual Review of Psychology* 41:417–40. [aRAD]
- Dixon, A. (1998) *Primate sexuality*. Oxford University Press. [aRAD]
- Domjan, M., Cusato, B. & Villarreal, R. (2000) Pavlovian feed-forward mechanisms in the control of social behavior. *Behavioral and Brain Sciences* 23:1–29. [aRAD]
- Doty, R. & Rissler, J. (1989) Influence of the D-2 dopamine receptor agonist quinpirole on the odor detection performance of rats before and after spiperone administration. *Psychopharmacology* 98:310–15. [aRAD]
- Doty, R., Li, C., Bagla, A., Huang, W., Pfeffer, C., Brosvic, G. & Rissler, J. (1998) SKF 38393 enhances odor detection performance. *Psychopharmacology* 136:75–82. [aRAD]
- Dougherty, D. D., Shin, L. M., Alpert, N. M., Pitman, R. K., Orr, S. P., Lasko, M. P., Macklin, M. L., Fischman, A. J. & Rauch, S. L. (1999) Anger in healthy men: A PET study using script-driven imagery. *Biological Psychiatry* 46:466–72. [DJZ]
- Doyle, T. F., Bellugi, U., Korenberg, J. R. & Graham, J. (2004) “Everybody in the world is my friend”: Hypersociability in young children with Williams’ syndrome. *American Journal of Medical Genetics* 124A:263–73. [AT]
- Drago, F., Caldwell, J., Pedersen, C., Continnella, G., Scapagnini, U. & Prange, A. (1986) Dopamine neurotransmission in the nucleus accumbens may be involved in oxytocin-enhanced grooming behavior of the rat. *Pharmacology, Biochemistry and Behavior* 24:1185–88. [aRAD]
- Drago, F., Contarino, A. & Busa, L. (1999) The expression of neuropeptide-induced excessive grooming behavior in dopamine D1 and D2 receptor-deficient mice. *European Journal of Pharmacology* 365:125–31. [aRAD]
- Drevets, W. C. (2001) Neuroimaging and neuropathological studies of depression: Implications for cognitive-emotional features of mood disorders. *Current Opinion in Neurobiology* 11:240–49. [aRAD]
- Drevets, W. C., Gautier, C., Price, J. C., Kupfer, D. J., Kinahan, P. E., Grace, A. A., Price, J. L. & Mathis, C. A. (2001) Amphetamine-induced dopamine release in human ventral striatum correlates with euphoria. *Biological Psychiatry* 49:81–96. [aRAD]
- Drevets, W. C., Price, J. L., Simpson, J. J., Todd, R. D., Reich, T., Vannier, M. & Raichle, M. E. (1997) Subgenual prefrontal cortex abnormalities in mood disorders. *Nature* 386:824–27. [DAP]
- Dubini, A., Bosc, M. & Polin, V. (1997) Noradrenaline-selective versus serotonin-selective antidepressant therapy: Differential effects on social functioning. *Journal of Psychopharmacology* 11:S17–S23. [SNY]
- Dudai, U. (1989) *The neurobiology of memory: Concepts, findings, trends*. Oxford University Press. [aRAD]
- Dunbar, R. (1991) Functional significance of social grooming in primates. *Folia Primatologica* 57:121–31. [TARW]
- Duvauchelle, C., Fleming, S. & Kornetsky, C. (1996) Involvement of delta- and mu-opioid receptors in the potentiation of brain-stimulation reward. *European Journal of Pharmacology* 316:137–43. [aRAD]
- Dworkin, S., Guerin, G., Goeders, N. & Smith, J. (1988) Kainic acid lesions of the nucleus accumbens selectively attenuate morphine self-administration. *Pharmacology, Biochemistry and Behavior* 29:175–81. [aRAD]
- Eastman, R. F. & Mason, W. A. (1975) Looking behavior in monkeys raised with mobile and stationary artificial mothers. *Developmental Psychobiology* 8:213–21. [TARW]
- Eibl-Eibesfeldt, I. (1975). *Ethology: The biology of behavior*, 2nd edition. Holt, Rinehart & Winston. [SLB]
- Eisenberg, L. & Earls, F. (1975) Poverty, social depreciation and child development. In: *American handbook of psychiatry*, ed. D. Amburg. Basic Books. [aRAD]
- Eisenberger, N. I., Lieberman, M. D. & Williams, K. D. (2003) Does rejection hurt? An fMRI study of social exclusion. *Science* 302:290–92. [aRAD]
- Eisler, R. & Levine, D. S. (2002) Nurture, nature, and caring: We are not prisoners of our genes. *Brain and Mind* 3:9–52. [DSL]
- Elliott, R., Frith, C. & Dolan, R. (1997) Differential response to positive and negative feedback in planning and guessing tasks. *Neuropsychologia* 35:1395–1404. [aRAD]
- Elmer, G. I., Pieper, J. O., Goldberg, S. R. & George, F. R. (1995) Opioid operant self-administration, analgesia, stimulation and respiratory depression in μ -deficient mice. *Psychopharmacology* 117:23–31. [aRAD]
- Emery, N. J. & Amaral, D. G. (2000) The role of the mygdala in primate social cognition. In: *Cognitive neuroscience of emotion*, ed. R. D. Lane & L. Nadel. Oxford University Press. [aRAD]
- Engelmann, M., Ebner, K., Wotjak, C. T. & Landgraf, R. (1998) Endogenous oxytocin is involved in short-term olfactory memory in female rats. *Behavioural Brain Research* 90:89–94. [aRAD]
- Engelmann, M., Wotjak, C. T., Neumann, I., Ludwig, M. & Landgraf, R. (1996) Behavioral consequences of intracerebral vasopressin and oxytocin: Focus on learning and memory. *Neuroscience and Biobehavioral Reviews* 20(3):341–58. [aRAD]
- Escalona, A., Field, T., Nadel, J. & Lundy, B. (2002) Brief report: Imitation effects on children with autism. *Journal of Autism and Developmental Disorders* 32:141–44. [R-PB]
- Ettenberg, A., Pettit, H., Bloom, F. & Koob, G. (1982) Heroin and cocaine intravenous self-administration in rats: Mediation by separate neural systems. *Psychopharmacology* 78:204–09. [aRAD]
- Everitt, B. (1990) Sexual motivation: A neural and behavioral analysis of the mechanisms underlying appetitive and copulatory responses of male rats. *Neuroscience and Biobehavioral Review* 14:217–32. [aRAD]
- Everitt, B. & Robbins, T. (1992) Amygdala-ventral striatal interactions and reward-related processes. In: *The amygdala: Neurobiological aspects of emotion, memory, and mental dysfunction*, ed. J. Aggleton. Wiley-Liss. [aRAD]
- Everitt, B., Parkinson, J., Olmstead, M., Arroyo, M., Robledo, P. & Robbins, T. (1999) Associative processes in addiction and reward: The role of amygdala-ventral striatal subsystems. In: *Advancing from the ventral striatum to the extended amygdala*, ed. J. F. McGinty. *Annals of the New York Academy of Sciences* 877:412–38. [aRAD]
- Eysenck, H. J. (1967) *The biological basis of personality*. Charles C. Thomas. [MZ]
- (1990) Biological dimensions of personality. In: *Handbook of personality: Theory and research*, ed. L. A. Pervin, pp. 244–276. Guilford. [MRM]
- Eysenck, H. J. & Eysenck, M. W. (1985) *Personality and individual differences: A natural science approach*. Plenum. [aRAD]
- Eysenck, H. J. & Eysenck, S. B. G. (1975) *Manual of the Eysenck Personality Questionnaire*. Educational and Industrial Testing Service. [aRAD]
- Fabre-Nys, C., Ohkura, A. & Kendrick, K. M. (1997) Male faces and odours evoke differential patterns of neurochemical release in the mediobasal hypothalamus of the ewe during oestrus: An insight into sexual motivation? *European Journal of Neuroscience* 9:1666–77. [aRAD]
- Fagen, R. (1993) Primate juveniles and primate play. In: *Juvenile primates: Life history, development, and behavior*, ed. M. E. Pereira & L. A. Fairbanks, pp. 182–196. Oxford University Press. [TARW]
- Fanon, F. (1982) *Black skin, white masks*, trans. C. M. Markmann. Grove. [NNP]
- Faurion, A., Cerf, B., Le Bihan, D. & Pillias, A. M. (1998) fMRI study of taste cortical areas in humans. *Annals of the New York Academy of Sciences* 855:535–45. [PO]
- Feibleman, J. K. (1954) Theory of integrative levels. *British Journal for the Philosophy of Science* 5:59–66. [TARW]
- Feighner, J. P. (1999) Mechanism of action of antidepressant medications. *Journal of Clinical Psychiatry* 60(S4):4–11. [DJZ]
- Feldman, R., Greenbaum, C. W. & Yirmiya, N. (1999) Mother-infant affect synchrony as an antecedent of the emergence of self-control. *Developmental Psychology* 35:223–31. [R-PB]
- Ferguson, J., Young, L., Hearn, E., Mtzuk, M., Insel, T. R. & Winslow, J. (2000) Social amnesia in mice lacking the oxytocin gene. *Nature Genetics* 25:284–88. [aRAD]
- (2001) Oxytocin in the medial amygdala is essential for social recognition in the mouse. *Journal of Neuroscience* 21:8278–85. [aRAD]
- Ferrante, F. (1996) Principles of opioid pharmacotherapy. *Journal of Pain and Symptom Management* 11:265–73. [aRAD]
- Fibiger, H. & Phillips, A. (1987) Role of catecholamine transmitters in brain reward systems: Implications for the neurobiology of affect. In: *Brain reward systems and abuse*, ed. J. Engel & L. Orelund. Raven. [aRAD]
- Field, T. (1995) Infants of depressed mothers. *Infant Behavior and Development* 18:1–13. [DAP]
- Field, T., Healy, B., Goldstein, S. & Guthertz, M. (1990) Behavior-state matching and synchrony in mother-infant interactions of non-depressed versus depressed dyads. *Developmental Psychology* 26:7–14. [DAP]
- Field, T., Sanders, C. & Nadel, J. (2001) Children with autism display more social behaviors after repeated imitation sessions. *Autism* 5:317–23. [R-PB]
- Fisher-Beckfield, D. & McFall, R. M. (1982) Development of competence inventory for college men and evaluation of relationships between competence and depression. *Journal of Consulting and Clinical Psychology* 50:697–705. [DAP]
- Fleming, A. S., Korsmit, M. & Deller, M. (1994) Rat pups are potent reinforcers to the maternal animal: Effects of experience, parity, hormones, and dopamine function. *Psychobiology* 22(1):44–53. [aRAD]
- Fleming, A. S., O’Day, D. H. & Kraemer, G. W. (1999) Neurobiology of mother–infant interactions: Experience and central nervous system plasticity across

- development and generations. *Neuroscience and Biobehavioral Reviews* 23:673–85. [aRAD]
- Floyd, K. (2002) Human affection exchange: V. Attributes of the highly affectionate. *Communication Quarterly* 50:135–52. [WBM]
- Forsling, M. (1986) Regulation of oxytocin release. In: *Current topics in Neuroendocrinology, vol 6. Neurobiology of oxytocin*, ed. D. Gantner. Springer-Verlag. [aRAD]
- Fowles, D. C. (1987) Application of a behavioral theory of motivation to the concepts of anxiety and impulsivity. *Journal of Research in Personality* 21:417–35. [aRAD]
- Fraley, R. C., Davis, K. E. & Shaver, P. R. (1998) Dismissing-avoidance and the defensive organization of emotion, cognition, and behavior. In: *Attachment theory and close relationships*, ed. J. A. Simpson & W. S. Rholes. Guilford. [AT]
- Freund, T., Powell, J. & Smith, J. D. (1984) Tyrosine hydroxylase-immunoreactive boutons in synaptic contact with identified striatonigral neurons, with particular reference to dendritic spines. *Neuroscience* 13:1189–1215. [aRAD]
- Frey, S. & Petrides, M. (2000) Orbitofrontal cortex: A key prefrontal region for encoding information. *Proceedings of the National Academy of Sciences* 97:8723–27. [aRAD]
- Frost, J. J., Douglass, K., Mayberg, H., Dannals, R., Links, J., Wilson, A., Ravert, H., Crozier, W. & Wagner, H. (1989) Multicompartmental analysis of [¹¹C]-carfentanil binding to opiate receptors in humans measured by positron emission tomography. *Journal of Cerebral Blood Flow Metabolism* 9:398–409. [aRAD]
- Frost, J. J., Mayberg, H., Fisher, R., Douglass, K., Dannals, R., Links, J., Wilson, A., Ravert, H., Rosenbaum, A. & Snyder, S. (1988) Mu-opiate receptors measured by positron emission tomography are increased in temporal lobe epilepsy. *Annals of Neurology* 23:231–37. [aRAD]
- Fullard, W. & Reiling, A. M. (1976) An investigation of Lorenz's "babyness." *Child Development* 47(4):1191–93. [aRAD]
- Fuller, T. A., Russchen, F. T. & Price, J. L. (1987) Sources of presumptive glutamatergic/aspartergic afferents to the rat ventral striatopallidal region. *Journal of Comparative Neurology* 258(3):317–38. [aRAD]
- Gaffan, D. (1992) Amygdala and the memory of reward. In: *The amygdala: Neurobiological aspects of emotion, memory, and mental dysfunction*, ed. J. Aggleton. Wiley-Liss. [aRAD]
- Gallagher, M. & Holland, P. (1994) The amygdala complex: Multiple roles in associative learning and attention. *Proceedings of the National Academy of Sciences USA* 91:11771–76. [aRAD]
- Gallagher, M., McMahan, R. & Shoenbaum, G. (1999) Orbitofrontal cortex and representation of incentive value in associative learning. *Journal of Neuroscience* 19:6610–14. [aRAD]
- Garcia, J. L. A. (2001) Is being Hispanic an identity? Reflections on J. J. E. Gracia's account. *Philosophy and Social Criticism* 27(2):29–43. [NNP]
- Gaspar, P., Berger, B., Febrvet, A., Vigny, A. & Henry, J. P. (1989) Catecholamine innervation of the human cerebral cortex as revealed by comparative immunohistochemistry of tyrosine hydroxylase and dopamine-beta-hydroxylase. *Journal of Comparative Neurology* 279:249–71. [DAP]
- Gelernter, J., Kranzler, H. & Cubells, J. (1999) Genetics of two μ opioid receptor gene (OPRM1) exon I polymorphisms: Population studies, and allele frequencies in alcohol- and drug-dependent subjects. *Molecular Psychiatry* 4:476–83. [aRAD]
- Gerber, G. & Wise, R. (1989) Pharmacological regulation of intravenous cocaine and heroin self-administration in rats: A variable dose paradigm. *Pharmacology, Biochemistry and Behavior* 32:527–31. [aRAD]
- Gerrits, M., Ramsey, N., Wolterink, G. & van Ree, J. (1994) Lack of evidence for an involvement of nucleus accumbens dopamine D1 receptors in the initiation of heroin self-administration in the rat. *Psychopharmacology* 94:486–94. [aRAD]
- Gerrits, M., Wiegant, V. & van Ree, J. (1999) Endogenous opioids implicated in the dynamics of experimental drug addiction: An in vivo autoradiographic analysis. *Neuroscience* 89:1219–27. [aRAD]
- Chazanfar, A. A. & Santos, L. R. (2004) Primate brains in the wild: The sensory bases for social interactions. *Nature Reviews Neuroscience* 5:609–16. [rRAD]
- Gianoulakis, C. (1993) Endogenous opioids and excessive alcohol consumption. *Journal of Psychiatry and Neuroscience* 18:148–56. [aRAD]
- Gianoulakis, C. & deWaele, J. (1994) Genetics of alcoholism. *Metabolism and Brain Disorders* 9:105–31. [aRAD]
- Gianoulakis, C., deWaele, J. & Kiiianmaa, K. (1992) Differences in the brain and pituitary beta-endorphin system between the alcohol-preferring AA and alcohol-avoiding ANA rats. *Alcoholism: Clinical and Experimental Research* 16:453–59. [aRAD]
- Gianoulakis, C., Krishnan, B. & Thavundayil, J. (1996) Enhanced sensitivity of pituitary beta-endorphin to ethanol in subjects at high risk of alcoholism. *Archives of General Psychiatry* 53:250–57. [aRAD]
- Gingrich, B., Liu, Y., Cascio, C., Wang, Z. & Insel, T. R. (2000) Dopamine D2 receptors in the nucleus accumbens are important for social attachment in female prairie voles (*Microtus ochrogaster*). *Behavioral Neuroscience* 114(1):173–83. [aRAD]
- Goldberg, L. (1981) Language and individual differences: The search for universals in personality lexicons. In: *Review of personality and social psychology, vol. 2*, ed. L. Wheeler. Sage. [aRAD]
- Goldberg, L. & Rosolack, T. (1994) The big five factor structure as an integrative framework. In: *The developing structure of temperament and personality from infancy to adulthood*, ed. C. Halverson, G. Kohnstamm & R. Marten. Erlbaum. [aRAD]
- Goldman-Rakic, P. S. (1987) Circuitry of the prefrontal cortex and the regulation of behavior by representational memory. In: *Handbook of physiology*, ed. V. Mountcastle. American Physiological Society. [aRAD]
- Gonon, F. (1988) Nonlinear relationship between impulse flow and dopamine released by rat midbrain dopamine neurons as studied by *in vivo* electrochemistry. *Neuroscience* 24:19–32. [aRAD]
- Gozaalka, B. & Lester, G. (1987) Oxytocin-induced facilitation of lordosis behaviour in rats is progesterone-dependent. *Neuropeptides* 10:55–65. [aRAD]
- Gosling, S. (2001) From mice to men: What can we learn about personality from animal research? *Psychological Bulletin* 127:45–86. [aRAD]
- Gotlib, I. H. & Asarnow, R. F. (1979) Interpersonal and impersonal problem-solving skills in mildly and clinically depressed university students. *Journal of Consulting and Clinical Psychology* 47:86–95. [DAP]
- Goto, Y. & O'Donnell, P. (2002) Timing-dependent limbic-motor synaptic integration in the nucleus accumbens. *Proceedings of the National Academy of Sciences USA* 99:13189–93. [PO]
- Gottesman, I. I. & Gould, T. D. (2003) The endophenotype concept in psychiatry: Etymology and strategic intentions. *American Journal of Psychiatry* 160:636–45. [AT]
- Gottfried, J. A., O'Doherty, J. & Dolan, R. J. (2003) Encoding predictive reward value in human amygdala and orbitofrontal cortex. *Science* 301:1104–07. [aRAD]
- Gottman, J., Swanson, C. & Swanson, K. (2002) A general systems theory of marriage: Nonlinear difference equation modeling of marital interaction. *Personality and Social Psychology Review* 6:326–40. [KI]
- Grace, A. (1991) Phasic versus tonic dopamine release and the modulation of dopamine system responsivity. *Neuroscience* 41:1–24. [aRAD]
- Gracy, K. N. & Pickel, V. M. (1996) Ultrastructural immunocytochemical localization of the N-methyl-D-aspartate (NMDA) receptor and tyrosine hydroxylase in the shell of the rat nucleus accumbens. *Brain Research* 739:169–81. [aRAD]
- Gracy, K. N., Svings, A. L. & Pickel, V. M. (1997) Dual ultrastructural localization of μ -opioid receptors and NMDA-type glutamate receptors in the shell of the rat nucleus accumbens. *Journal of Neuroscience* 17(12):4839–48. [aRAD]
- Graves, F. C., Wallen, K. & Maestripieri, D. (2002) Opioids and attachment in rhesus macaque abusive mothers. *Behavioral Neuroscience* 116:489–93. [aRAD]
- Gray, J. A. (1973) Causal theories of personality and how to test them. In: *Multivariate analysis and psychological theory*, ed. J. R. Royce. Academic Press. [aRAD]
- (1982) *The neuropsychology of anxiety: An enquiry into the function of the septohippocampal system*. Oxford University Press. [MZ]
- (1987) The neuropsychology of emotion and personality. In: *Cognitive neurochemistry*, ed. S. M. Stahl, S. D. Iverson & E. C. Goodman, pp. 171–190. Oxford University Press. [MZ]
- (1992) Neural systems, emotion and personality. In: *Adaptation, learning and affect*, ed. J. Madden, S. Mattheyse & J. Barchas. Raven Press. [aRAD]
- Gray, J. A., Feldon, J., Rawlings, J., Hemsley, D. & Smith, A. (1991) The neuropsychology of schizophrenia. *Behavioral and Brain Sciences* 14:1–84. [aRAD]
- Gray, J. R. (2001) Emotional modulation of cognitive control: Approach-withdrawal states double-dissociate spatial from verbal two-back task performance. *Journal of Experimental Psychology: General* 130:436–52. [SLB]
- (2004) Integration of emotion and cognitive control. *Current Directions in Psychological Science* 13:46–48. [SLB]
- Gray, J. R., Braver, T. S. & Raichle, M. E. (2002) Integration of emotion and cognition in the lateral prefrontal cortex. *Proceedings of the National Academy of Sciences, USA* 99: 4115–20. [SLB]
- Graybiel, A. (1995) Building action repertoires: Memory and learning functions of the basal ganglia. *Current Opinion in Neurology* 5:733–41. [aRAD]
- (1997) The basal ganglia and cognitive pattern generators. *Schizophrenia Bulletin* 23:459–69. [aRAD]
- (1998) The basal ganglia and chunking of action repertoires. *Neurobiology of learning and memory* 70(1–2):119–136. [aRAD]
- Grazzini, E., Guillon, G., Mouillac, B. & Zingg, H. H. (1998) Inhibition of oxytocin

- receptor function by direct binding of progesterone. *Nature* 392:509–12. [PJZ]
- Green, L. A., Fein, D., Modahl, C., Feinstein, C., Waterhouse, L. & Morris, M. (2001) Oxytocin and autistic disorder: Alterations in peptide forms. *Biological Psychiatry* 50:609–13. [R-PB]
- Greenough, W. & Black, J. (1992) Induction of brain structure by experience: Substrates for cognitive development. In: *Minnesota symposia on child psychology, vol. 24*, ed. M. Gunnar & C. Nelson. University of Minnesota Press. [aRAD]
- Greenwald, M., June, H., Stitzer, M. & Marco, A. (1996) Comparative clinical pharmacology of short-acting mu opioids in drug abusers. *Journal of Pharmacology and Experimental Therapeutics* 277:1228–36. [aRAD]
- Grill, H. & Coons, E. (1976) The CNS weighting of external and internal factors in feeding behavior. *Behavioral Biology* 18:563–69. [aRAD]
- Groenewegen, H. (1988) Organization of the afferent connections of the mediodorsal thalamic nucleus related to the mediodorsal-prefrontal topography. *Neuroscience* 24:379–92. [aRAD]
- Groenewegen, H., Berendse, H., Meredith, G., Haber, S., Voorn, P., Wolters J. & Lohman A. (1991) Functional anatomy of the ventral, limbic system-innervated striatum. In: *The mesolimbic dopamine system: Motivation to action*, ed. P. Willner & J. Scheel-Kruger. Wiley. [aRAD]
- Groenewegen, H., Berendse, H., Wolters J. & Lohman A. (1990) The anatomical relationship of the prefrontal cortex with the striatopallidal system, the thalamus and the amygdala: Evidence for a parallel organization. In: *The prefrontal cortex: Its structure, function, and pathology*, ed. H. Uylings, C. Van Eden, J. De Bruin, M. Corner & M. Feenstra. Elsevier. [aRAD]
- Groenewegen, H., Mulder, A. B., Beijer, A. V. J., Wright, C. I., Lopes da Silva, F. & Pennartz, C. M. A. (1999a) Hippocampal and amygdaloid interactions in the nucleus accumbens. *Psychobiology* 27(2):149–64. [aRAD]
- Groenewegen, H., Wright, C., Beijer, A. & Voorn, P. (1999b) Convergence and segregation of ventral striatal inputs and outputs. In: *Advancing from the ventral striatum to the extended amygdala*, ed. J. F. McGinty. *Annals of the New York Academy of Sciences* 877:49–63. [aRAD]
- Grossberg, S. (2000) The complementary brain: Unifying brain dynamics and modularity. *Trends in Cognitive Sciences* 4:233–46. [DSL]
- Groves, P., Garcia-Munoz, M., Linder, J., Manley, M., Martone, M. & Young, S. (1995) Elements of the intrinsic organization and information processing in the neostriatum. In: *Models of information processing in basal ganglia*, ed. J. Houk, J. Davis & D. Beiser. MIT Press. [aRAD]
- Guard, H. J., Newman, J. D. & Roberts, R. L. (2002) Morphine administration selectively facilitates social play in common marmosets. *Developmental Psychobiology* 41:37–49. [TARW]
- Guilford, J. P. & Zimmerman, W. (1949) *The Guilford-Zimmerman Temperament Survey: Manual*. Sheridan Supply. [aRAD]
- Haber, S. N., Fudge, J. L. & McFarland, N. R. (2000) Striatonigrostriatal pathways in primates form an ascending spiral from the shell to the dorsolateral striatum. *Journal of Neuroscience* 20:2369–82. [PO]
- Hammock, A. S. & Young, L. J. (2002) Variation in the vasopressin V1a receptor promoter and expression: Implications for inter- and intraspecific variation in social behaviour. *European Journal of Neuroscience* 16:399–402. [aRAD]
- Harlow, H. (1958) The nature of love. *American Psychologist* 13(12):673–85. [NNP]
- Harlow, H. & Zimmerman, R. (1996) Affective responses in the infant monkey. In: *Foundations of animal behavior: Classic papers with commentaries*, ed. L. Houck & L. Drickamer, pp. 376–387. University of Chicago Press. [NNP]
- Harris, G. C. & Aston-Jones, G. (2003) Altered motivation and learning following opiate withdrawal: Evidence for prolonged dysregulation of reward processing. *Neuropsychopharmacology* 28(5):865–71. [JES]
- Harris, J. (1995) Where is the child's environment? A group socialization theory of development. *Psychological Review* 102(3):458–89. [MG]
- Harris, N. S., Courchesne, E., Townsend, J., Carper, R. A. & Lord, C. (1999) Neuroanatomic contributions to slowed orienting of attention in children with autism. *Brain Research. Cognitive Brain Research* 8:61–71. [R-PB]
- Hayaki, H. (1983) The social interactions of juvenile Japanese monkeys on Koshima Islet Japan. *Primates* 24(2):139–53. [TARW]
- Hebb, D. O. (1949) *The organization of behavior*. Wiley. [aRAD]
- Heimer L (2003) A new anatomical framework for neuropsychiatric disorders and drug abuse. *American Journal of Psychiatry* 160:1726–39. [aRAD]
- Heimer, L., Alheid, G. & Zahm, D. (1993) Basal forebrain organization: An anatomical framework for motor aspects of drive and motivation. In: *Limbic motor circuits and neuropsychiatry*, ed. P. Kalivas & C. Barnes. CRC Press. [aRAD]
- Helgeson, V. (1994) Relation of agency and communion to well-being. *Psychological Bulletin* 116:412–28. [aRAD]
- Henriksen, S. & Giacchino, J. (1993) Functional characteristics of nucleus accumbens neurons: Evidence obtained from *in vivo* electrophysiological recordings. In: *Limbic motor circuits and neuropsychiatry*, ed. P. Kalivas & C. Barnes. CRC Press. [aRAD]
- Henriques, J. B. & Davidson, R. J. (2000) Decreased responsiveness to reward in depression. *Cognition and Emotion* 14:711–24. [DAP]
- Henry, J. & Wang, S. (1998) Effects of early stress on adult affiliative behavior. *Psychoneuroendocrinology* 23:863–75. [SLB, aRAD]
- Herbert, J. (1993) Peptides in the limbic system: Neurochemical codes for coordinated adaptive responses to behavioural and physiological demand. *Progress in Neurobiology* 41:723–91. [aRAD]
- Hernandez-Avila, C. A., Covault, J., Gelernter, J. & Kranzler, H. R. (2004) Association study of personality factors and the Asn40Asp polymorphism at the mu-opioid receptor gene (OPRM1). *Psychiatric Genetics* 14:89–92. [MRM]
- Hernandez-Avila, C. A., Wand, G., Luo, X., Gelernter, J. & Kranzler, H. R. (2003) Association between the cortisol response to opioid blockade and the Asn40Asp polymorphism at the mu-opioid receptor locus (OPRM1). *American Journal of Medical Genetics* 118B:60–65. [MRM]
- Herpertz, S. C. & Sass, H. (2000) Emotional deficiency and psychopathy. *Behavioral Science and Law* 18:567–80. [AT]
- Herz, A. (1998) Opioid reward mechanisms: A key role in drug abuse? *Canadian Journal of Physiology and Pharmacology* 76:252–58. [aRAD]
- Heyser, C., Roberts, A., Schulteis, G. & Koob, G. (1999) Central administration of an opiate antagonist decreases oral ethanol self-administration in rats. *Alcohol Clinical and Experimental Research* 23:1468–76. [aRAD]
- Higley, J. D. & Suomi, S. J. (1996) Effect of reactivity and social competence on individual responses to severe stress in children: Investigations using nonhuman primates. In: *Intense stress and mental disturbance in children*, ed. C. R. Pfeffer. American Psychiatric Press. [DJZ]
- Higley, J. D., Mehlman, P. T., Higley, S. B., Fernald, B., Vickers, J., Lindell, S. G., Taub, D. M., Suomi, S. J. & Linnoila, M. (1996) Excessive mortality in young free-ranging male nonhuman primates with low cerebrospinal fluid 5-hydroxyindoleacetic acid concentrations. *Archives of General Psychiatry* 53:537–43. [SNY]
- Higley, J. D., Suomi, S. J. & Linnoila, M. (1992) A longitudinal assessment of CSF monoamine metabolite and plasma cortisol concentrations in young rhesus monkeys. *Biological Psychiatry* 32:127–45. [DJZ]
- Hikosaka, K. & Watanabe, M. (2000) Delay activity of orbital and lateral prefrontal neurons of the monkey varying with different rewards. *Cerebral Cortex* 10:263–71. [aRAD]
- Hillegaart, V., Alster, P., Uvnas-Moberg, K. & Ahlenius, S. (1998) Sexual motivation promotes oxytocin secretion in male rats. *Peptides* 19:39–45. [aRAD]
- Hilliard, S., Domjan, M., Nguyen, M. & Cusato, B. (1998) Dissociation of conditioned appetitive and consummatory sexual behavior: Satiation and extinction tests. *Animal Learning and Behavior* 26(1):20–33. [aRAD]
- Hinde, R. A. (1992) Developmental psychology in the context of other behavioral sciences. *Developmental Psychobiology* 28(6):1018–29. [TARW]
- Hinde, R. A. & Spencer-Booth, Y. (1967) The behaviour of socially living rhesus monkeys in their first two and a half years. *Animal Behaviour* 15:169–96. [TARW]
- Hobson, P. (1986) The autistic child's appraisal of emotion. *Journal of Child Psychology and Psychiatry* 27:321–42. [R-PB]
- Hoebel, B., Monaco, A., Hernandez, L., Aulisi, E., Stanley, B. & Lenard, L. (1983) Self-injection of amphetamine directly into the brain. *Psychopharmacology* 81:158–63. [aRAD]
- Hofer, M. (1997) Hidden regulators: Implications for a new understanding of attachment, separation, and loss. In: *Attachment theory: Social, developmental, and clinical perspectives*, ed. S. Goldberg, R. Muir & J. Kerr. Analytic Press. [aRAD]
- Hofer, M., Shair, H. & Murowchick, E. (1989) Isolation distress and maternal comfort responses of two-week old rat pups reared in social isolation. *Developmental Psychobiology* 22:553–66. [aRAD]
- Hoffman, K. A., Mendoza, S. P., Hennessy, M. B. & Mason, W. A. (1995) Responses of infant titi monkeys, *Callicebus moloch*, to removal of one or both parents: Evidence for paternal attachment. *Developmental Psychobiology* 28:399–407. [TARW]
- Hogan, R. (1983) A socioanalytic theory of personality. In: *1982 Nebraska Symposium on Motivation*, ed. M. Page. University of Nebraska Press. [aRAD]
- Hol, T., Niesink, M., van Ree, J. & Spruijt, B. (1996) Prenatal exposure to morphine affects juvenile play behavior and adult social behavior in rats. *Pharmacology, Biochemistry, and Behavior* 55:615–18. [aRAD]
- Holstege, G. (1991) Descending motor pathways and the spinal motor system: Limbic and nonlimbic components. *Progress in Brain Research* 87:307–56. [aRAD]
- (1992) The emotional motor system. *European Journal of Morphology* 30:67–81. [aRAD]
- Horvitz, J. C. (2000) Mesolimbocortical and nigrostriatal dopamine responses to salient non-reward events. *Neuroscience* 96:651–56. [PO, DJZ]
- Houdi, A., Bardo, M. & van Loon, G. (1989) Opioid mediation of cocaine-induced hyperactivity and reinforcement. *Brain Research* 497:195–98. [aRAD]

- Houk, J., Adams, J. & Barto, A. (1995) A model of how the basal ganglia generate and use neural signals that predict reinforcement. In: *Models of information processing in the basal ganglia*, ed. J. Houk, J. Davis & D. Beiser. MIT Press. [aRAD]
- Hughes, J. R., Pleasants, C. N. & Pickens, R. W. (1985) Measurement of reinforcement in depression: A pilot study. *Journal of Behavior Therapy and Experimental Psychiatry* 16:185–88. [DAP]
- Hull, E. M., Du, J., Lorrain, D. S. & Matuszewich, L. (1995) Extracellular dopamine in the medial preoptic area: Implications for sexual motivation and hormonal control of copulation. *Journal of Neuroscience* 15(11):7465–71. [aRAD]
- Hulting, A., Grenback, E., Pineda, R., Coya, R., Uvnas-Moberg, K., Meister, B. & Hokfelt, T. (1996) Effect of oxytocin on growth hormone release in vitro. *Regulatory Peptides* 67:69–73. [aRAD]
- Hurley, J. R. (1998) Agency and communion as related to “big five” self-representations and subsequent behavior in small groups. *Journal of Psychology* 132:337–51. [aRAD]
- Hyztia, P. & Kianmaa, K. (2001) Suppression of ethanol responding by centrally administered CTOP and naltrindole in AA and Wistar rats. *Alcohol Clinical and Experimental Research* 25:25–33. [aRAD]
- Ikemoto, S. & Panksepp (1996) Dissociations between appetitive and consummatory responses by pharmacological manipulations of reward-relevant brain regions. *Behavioral Neuroscience* 110:331–45. [aRAD]
- (1999) The role of nucleus accumbens dopamine in motivated behavior: A unifying interpretation with special reference to reward-seeking. *Brain Research Reviews* 31:6–41. [JP]
- Insel, T. (1992) Oxytocin – A neuropeptide for affiliation: Evidence from behavioral, receptor autoradiographic, and comparative studies. *Psychoneuroendocrinology* 17(1):3–35. [SLB, aRAD]
- Insel, T. R. (1997) A neurobiological basis of social attachment. *American Journal of Psychiatry* 154(6):726–33. [aRAD, JES]
- Insel, T. R. & Hulihan, T. (1995) A gender specific mechanism for pair bonding: Oxytocin and partner preference formation in monogamous voles. *Behavioral Neuroscience* 109:782–89. [aRAD]
- Insel, T. R. & Shapiro, L. E. (1992) Oxytocin receptor distribution reflects social organization in monogamous and polygamous voles. *Proceedings of the National Academy of Sciences USA* 89:5981–85. [aRAD]
- Insel, T. R. & Winslow, J. T. (1998) Serotonin and neuropeptides in affiliative behaviors. *Biological Psychiatry* 44:207–19. [aRAD]
- Insel, T. R. & Young, L. J. (2001) The neurobiology of attachment. *Nature Reviews Neuroscience* 2:129–36. [JP, AT]
- Insel, T. R., Preston, S. & Winslow, J. (1995) Mating in the monogamous male: Behavioral consequences. *Physiology & Behavior* 57:615–27. [aRAD]
- Insel, T. R., Young, L. & Wang, Z. (1997) Molecular aspects of monogamy. *Annals of the New York Academy of Sciences* 807:302–16. [aRAD]
- Insel, T. R., Young, L., Witt, D. & Crews, D. (1993) Gonadal steroids have paradoxical effects on brain oxytocin receptors. *Journal of Neuroendocrinology* 5:619–28. [aRAD]
- Itoh, K. (2002) Personality research with non-human primates: Theoretical formulation and methods. *Primates* 43:249–61. [aRAD, KI]
- Ivell, R. & Russell, J. (1996) Oxytocin: Cellular and molecular approaches in medicine and research. *Reviews in Reproduction* 1:13–18. [aRAD]
- Izard, C. (1994) Innate and universal facial expressions: Evidence from developmental and cross-cultural research. *Psychological Bulletin* 115:288–99. [R-PB]
- Jackson, D. (1984) *Personality Research Form Manual*, 3rd edition. Research Psychologists Press. [aRAD]
- Jackson, M. & Moghaddam, B. (2001) Amygdala regulation of nucleus accumbens dopamine output is governed by the prefrontal cortex. *Journal of Neuroscience* 21:676–81. [aRAD]
- Jacobs, B. L. & Fornal, C. A. (1995) Activation of 5-HT neuronal activity during motor behavior. *Seminars in the Neurosciences* 7:401–08. [SNY]
- Jaeger, R. & van der Kooy, D. (1996) Separate neural substrates mediate the motivating and discriminative properties of morphine. *Behavioral Neuroscience* 110:181–201. [aRAD]
- Jamner, L. D. & Leigh, H. (1999) Repressive/defensive coping, endogenous opioids and health. *Psychiatry Research* 85:17–31. [aRAD]
- Jaskiw, G., Tizabi, Y., Lipska, B., Kolachana, B., Wyatt, R. & Gilad, G. (1991) Evidence for a frontocortical-septal glutamatergic pathway and compensatory changes in septal glutamate uptake after cortical and fornix lesions in the rat. *Brain Research* 550:7–10. [aRAD]
- Jensen, J., McIntosh, A. R., Crawley, A. P., Mikulis, D. J., Remington, G. & Kapur, S. (2003) Direct activation of the ventral striatum in anticipation of aversive stimuli. *Neuron* 40:1251–57. [PO]
- Jezova, D., Juranlova, E., Mosnarova, A., Kriska, M. & Skultetyova, I. (1996) Neuroendocrine response during stress with relation to gender differences. *Acta Neurobiologia Experientia* 56:779–85. [aRAD]
- Jirkowski, G., Caldwell, J., Pilgrim, C., Stumpf, W. & Pedersen, C. (1989) Changes for immunostatin and for oxytocin in forebrain of the female rat during late pregnancy, parturition and early lactation. *Cell Tissue Research* 256:411–17. [aRAD]
- Jodogne, C., Marinelli, M., Le Moal, M. & Piazza, P. V. (1994) Animals predisposed to develop amphetamine self-administration show higher susceptibility to develop contextual conditioning of both amphetamine-induced hyperlocomotion and sensitization. *Brain Research* 657(1–2):236–44. [aRAD]
- Jog, M. S., Kubota, Y., Connolly, C. I., Hillegaart, J. & Graybiel, A. M. (1999) Building neural representations of habits. *Science* 286:1745–49. [aRAD]
- Johnson, A. E. (1992) The regulation of oxytocin receptor binding in the ventromedial hypothalamic nucleus by gonadal steroids. *Annals of the New York Academy of Sciences* 652:357–73. [aRAD]
- Johnson, B. & Ait-Daoud, N. (2000) Neuropharmacological treatments for alcoholism: Scientific basis and clinical findings. *Psychopharmacology* 149:327–44. [aRAD]
- Johnson, M. (2001) Functional brain development in humans. *Nature Reviews Neuroscience* 2:475–83. [R-PB]
- Johnson, M. H., Dziurawiec, S., Ellis, H. & Morton, J. (1991) Newborn’s preferential tracking of face-like stimuli and its subsequent decline. *Cognition* 40:1–19. [R-PB]
- Johnson, S., Seutin, V. & North, R. (1992) Burst firing in dopamine neurons induced by N-Methyl-D-Aspartate: Roles of electrogenic sodium pump. *Science* 258:665–67. [aRAD]
- Johnson, S. W. & North, R. A. (1992) Opioids excite dopamine neurons by hyperpolarization of local interneurons. *Journal of Neuroscience* 12(2):483–88. [aRAD]
- Kaitz, M., Good, A., Rokem, A. M. & Eidelman, A. I. (1987) Mothers’ recognition of their newborns by olfactory cues. *Developmental Psychobiology* 20(6):587–91. [aRAD]
- Kalin, N. H., Shelton, S. E. & Lynn, D. E. (1995) Opiate systems in mother and infant primates coordinate intimate contact during reunion. *Psychoneuroendocrinology* 20:735–42. [JES]
- Kalivas, P. (1995) Interactions between dopamine and excitatory amino acids in behavioral sensitization to psychostimulants. *Drug and Alcohol Dependence* 37:95–100. [aRAD]
- Kalivas, P. & Alesdatter, J. (1993) Involvement of NMDA receptor stimulation in the VTA and amygdala in behavioral sensitization to cocaine. *Journal of Pharmacology and Experimental Therapeutics* 267:486–95. [aRAD]
- Kalivas, P., Bush, L. & Hanson, G. (1995) High and low behavioral response to novelty is associated with differences in neurotensin and substance P content. *Annals of the New York Academy of Sciences* 873:164–67. [aRAD]
- Kalivas, P., Churchill, L. & Klitenick, M. (1993) The circuitry mediating the translation of motivational stimuli into adaptive motor responses. In: *Limbic motor circuits and neuropsychiatry*, ed. P. Kalivas & C. Barnes. CRC Press. [aRAD]
- Kalivas, P. W., Churchill, L. & Romanides, A. (1999) Involvement of the pallidum-thalamocortical circuit in adaptive behavior. In: *Advancing from the ventral striatum to the extended amygdala*, ed. J. F. McGinty. *Annals of the New York Academy of Sciences* 877:64–70. [aRAD]
- Kalivas, P. W. & Stewart, J. (1991) Dopamine transmission in the initiation and expression of drug- and stress-induced sensitization of motor activity. *Brain Research Reviews* 16(3):223–44. [aRAD]
- Kandel, E. R., Schwartz, J. H. & Jessell, T. M. (1991) *Principles of Neural Science*, 3rd edition. Appleton & Lange. [aRAD]
- Karen, R. (1994) *Becoming attached: Unfolding the mystery of the infant–mother bond and its impact on later life*. Warner Books. [NNP]
- Karnath, H.-O. (2001) New insights into the functions of the superior temporal cortex. *Nature Reviews Neuroscience* 2:568–76. [aRAD]
- Katzen-Perez, K., Jacobs, D., Lincoln, A. & Ellis, R. (2001) Opioid blockade improves human recognition memory following physiological arousal. *Pharmacology, Biochemistry and Behavior* 70:77–84. [aRAD]
- Kehoe, P. & Blass, E. (1989) Conditioned opioid release in ten-day-old rats. *Behavioral Neuroscience* 103:423–38. [aRAD]
- Kehoe, P. & Boylan, C. B. (1994) Behavioral effects of kappa-opioid-receptor stimulation on neonatal rats. *Behavioral Neuroscience* 108(2):418–23. [aRAD]
- Kelley, A. (1999a) Neural integrative activities of nucleus accumbens subregions in relation to learning and motivation. *Psychobiology* 27:198–213. [aRAD]
- (1999b) Functional specialization of ventral striatal compartments in appetitive behaviors. In: *Advancing from the ventral striatum to the extended amygdala*, ed. J. F. McGinty. *Annals of the New York Academy of Sciences* 877:71–90. [aRAD]
- Kelley, A., Bless, E. & Swanson, C. (1996) Investigation of the effects of opiate antagonists infused into the nucleus accumbens on feeding and sucrose drinking in rats. *Journal of Pharmacology and Experimental Therapeutics* 278:1499–1507. [aRAD]
- Kemper, C., Verbaten, M. N., Cuperus, J. M., Camfferman, G. & van Engeland, H.

- (1998) Abnormal saccadic eye movements in autistic children. *Journal of Autism and Developmental Disorders* 28:61–67. [R-PB]
- Kemper, T. L. & Bauman, M. (1998) Neuropathology of infantile autism. *Journal of Neuropathology and Experimental Neurology* 57:645–52. [R-PB]
- Kendrick, K. & Keverne, E. (1989) Effects of intracerebroventricular infusions of naltrexone and phentolamine on central and peripheral oxytocin release and on maternal behaviour induced by vaginocervical stimulation in the ewe. *Brain Research* 505:329–32. [aRAD]
- Kendrick, K. M. (2000) Oxytocin, motherhood and bonding. *Experimental Physiology* 85:111S–124S. [aRAD]
- Kendrick, K. M., Da Costa, A. P. A., Broad, K. D., Ohkura, S., Guevara, R., Levy, F. & Keverne, E. B. (1997) Neural control of maternal behaviour and olfactory recognition of offspring. *Brain Research Bulletin* 44(4):383–95. [aRAD]
- Kendrick, K. M., Levy, F. & Keverne, E. B. (1992) Changes in the sensory processing of olfactory signals induced by birth in sheep. *Science* 256:833–36. [aRAD]
- Keverne, E. B. (1996) Psychopharmacology of maternal behaviour. *Journal of Psychopharmacology* 10(1):16–22. [aRAD]
- Keverne, E. B. & Kendrick, K. M. (1991) Morphine and corticotrophin-releasing factor potentiate maternal acceptance in multiparous ewes after vaginocervical stimulation. *Brain Research* 540:55–62. [aRAD]
- (1992) Oxytocin facilitation of maternal behavior in sheep. *Annals of the New York Academy of Science* 652:83–101. [SLB]
- (1994) Maternal behaviour in sheep and its neuroendocrine regulation. *Acta Paediatrica Supplement* 397:47–56. [aRAD]
- Keverne, E. B., Levy, F., Pointron, P. & Lindsay, D. (1983) Vaginal stimulation: An important determinant of maternal bonding in sheep. *Science* 219:81–83. [aRAD]
- Keverne, E. B., Martensz, N. D. & Tuite, B. (1989) Beta-endorphin concentrations in cerebrospinal fluid of monkeys are influenced by grooming relationships. *Psychoneuroendocrinology* 14(1–2):155–61. [aRAD, JES]
- Keverne, E. B., Nevison, C. M. & Martel, F. L. (1997) Early learning and the social bond. In: *The integrative neurobiology of affiliation*, vol. 807, ed. C. S. Carter, I. I. Lederhendler & B. Kirkpatrick. New York: Academy of Sciences. [aRAD]
- Khachaturian, H., Schafer, M. & Lewis, M. (1993) Anatomy and function of the endogenous opioid systems. In: *Handbook of experimental pharmacology*, ed. A. Herz. Springer-Verlag. [aRAD]
- Kim, S., Grant, J., Adson, D. & Shin, Y. (2001) Double-blind naltrexone and placebo comparison study in the treatment of pathological gambling. *Biological Psychiatry* 49:914–21. [aRAD]
- Kimbrell, T. A., George, M. S., Parekh, P. I., Ketter, T. A., Podell, D. M., Danielson, A. M., Repella, J. D., Benson, B. E., Willis, M. W., Herscovitch, P. & Post, R. M. (1999) Regional brain activity during transient self-induced anxiety and anger in healthy adults. *Biological Psychiatry* 46:454–65. [DJZ]
- Kimura, T., Tanizawa, O., Mori, K., Brownstein, M. & Okyama, H. (1992) Structure and expression of a human oxytocin receptor. *Nature* 356:526–29. [aRAD]
- Kinsley, C. H., Morse, A. C., Zoumas, C., Corl, S. & Billack, B. (1995) Intracerebroventricular infusions of morphine, and blockade with naloxone, modify the olfactory preferences for pup odors in lactating rats. *Brain Research Bulletin* 37:103–07. [JES]
- Kitamura, Y., Miyazaki, A. & Nomura, Y. (1993) Stimulatory effects of protein kinase C and calmodulin kinase II on N-methyl-D-aspartate receptor/channels in the postsynaptic density of rat brain. *Journal of Neurochemistry* 61:100–09. [aRAD]
- Klitenick, M., Deutch, A., Churchill, L. & Kalivas, P. (1992) Topography and functional role of dopaminergic projections from the ventral mesencephalic tegmentum to the ventral pallidum. *Neuroscience* 50:371–82. [aRAD]
- Knapp, C. & Kornetsky, C. (1994) Bromocriptine, a D₂ receptor agonist, lowers the threshold for rewarding brain stimulation. *Pharmacology, Biochemistry, and Behavior* 49:901–04. [aRAD]
- Knox, S. S. & Uvnas-Moberg, K. (1998) Social isolation and cardiovascular disease: An atherosclerotic pathway? *Psychoneuroendocrinology* 23(8):877–90. [aRAD]
- Knutson, B., Cole, S., Wolkowitz, O., Reus, V., Chan, T. & Moore, E. (1997) Serotonergic intervention increases affiliative behavior in humans. *Annals of the New York Academy of Sciences* 807:492–93. [DJZ]
- Knutson, B., Wolkowitz, O. M., Cole, S. W., Chan, T., Moore, E. A., Johnson, R. C., Terpstra, J., Turner, R. A. & Reus, V. I. (1998) Selective alteration of personality and social behavior by serotonergic intervention. *American Journal of Psychiatry* 155:373–79. [SNY, DJZ]
- Kojima, Y. (1998) Continuity of affiliative relationships among infants and juveniles in a free-ranging group of Japanese monkeys (*Macaca fuscata*). *Psychological Reports* 82:691–700. [TARV]
- Koob, G. (1992) Drugs of abuse: Anatomy, pharmacology, and function of reward pathways. *Trends in Pharmacological Science* 13:177–98. [aRAD]
- (1999) The role of the striatopallidal and extended amygdala systems in drug addiction. *Annals of the New York Academy of Sciences* 877:412–38. [aRAD]
- Koob, G., Robledo, P., Markou, A. & Caine, S. B. (1993) The mesocorticolimbic circuit in drug dependence and reward – A role for the extended amygdala? In: *Limbic motor circuits and neuropsychiatry*, ed. P. Kalivas & C. Barnes. CRC Press. [aRAD]
- Koob, G. F. & Le Moal, M. (1997) Drug abuse: Hedonic homeostatic dysregulation. *Science* 278:52–58. [aRAD, JES]
- Kosobud, A., Harris, G. & Chapin, J. (1994) Behavioral associations of neuronal activity in the ventral tegmental area of the rat. *Journal of Neuroscience* 14:7117–29. [aRAD]
- Kovacs, G., Sarnyai, Z., Barbarcz, E., Szabo, G. & Telegdy, A. (1990) The role of oxytocin–dopamine interactions in cocaine-induced locomotor hyperactivity. *Neuropharmacology* 29:365–68. [aRAD]
- Kraemer, G. W. (1992) A psychobiological theory of attachment. *Behavioral and Brain Sciences* 15:493–541. [aRAD]
- Kraemer, G. W., Ebert, M. H., Schmidt, D. E. & McKinney, W. T. (1989) A longitudinal study of the effect of different social rearing conditions on cerebrospinal fluid norepinephrine and biogenic amine metabolites in rhesus monkeys. *Neuropsychopharmacology* 2:175–89. [DJZ]
- Kranzler, H. R. (2000) Pharmacotherapy of alcoholism: Gaps in knowledge and opportunities for research. *Alcohol and Alcoholism* 35:537–47. [aRAD]
- Krebs, M., Desce, J., Kemel, M., Gauchy, C., Godeheu, G., Cheramy, A. & Glowinski, J. (1991) Glutamate control of dopamine release in the rat striatum: Evidence for presynaptic N-methyl-D-aspartate receptors on dopaminergic nerve terminals. *Journal of Neurochemistry* 56:81–85. [aRAD]
- Kropotkin, P. (1902) *Mutual aid; a factor of evolution*. McClure, Philips. [MG]
- Krug, R., Pietrowsky, R., Fehm, H. L. & Born, J. (1994) Selective influence of menstrual cycle on perception of stimuli with reproductive significance. *Psychosomatic Medicine* 56:410–17. [aRAD]
- Krzyszowska, E., Ryan, D. & Braswell, S. (1998) Potency ratios of morphine and morphine-6-beta-glucuronide analgesia elicited from the periaqueductal gray, locus coeruleus or rostral ventromedial medulla of rats. *Brain Research* 799:329–33. [aRAD]
- Kuribara, H. (1996) Effects of interdose interval on ambulatory sensitization to methamphetamine, cocaine, and morphine in mice. *European Journal of Pharmacology* 316:1–5. [aRAD]
- La Buda, C., Sora, I., Uhl, G. & Fuchs, G. (2000) Stress-induced analgesia in mu-opioid receptor knockout mice reveals normal function of the delta-opioid receptor system. *Brain Research* 869:1–10. [aRAD]
- Laasonen-Balk, T., Kuikka, J., Viinamaki, H., Husso-Saastamoinen, M., Lehtonen, J. & Tiihonen, J. (1999) Striatal dopamine transporter density in major depression. *Psychopharmacology* 144:282–85. [DAP]
- Lacerda, A. L. T., Keshavan, M. S., Hardan, A. Y., Yorbik, O., Brambilla, P., Sassi, R. B., Nicoletti, M., Mallinger, A. G., Frank, E., Kupfer, D. J. & Soares, J. C. (2004) Anatomic evaluation of the orbitofrontal cortex in major depressive disorder. *Biological Psychiatry* 55:353–58. [DAP]
- Lachman, H. M., Papolos, D. F., Saito, T., Yu, Y. M., Szumlanski, C. L. & Weinshilboum, R. M. (1996) Human catechol-O-methyltransferase pharmacogenetics: Description of a functional polymorphism and its potential application to neuropsychiatric disorders. *Pharmacogenetics* 6:243–50. [PN]
- Larsson, K. & Ahlenius, S. (1999) Brain and sexual behavior. In: *Advancing from the ventral striatum to the extended amygdala*, ed. J. F. McGinty. *Annals of the New York Academy of Sciences* 877:292–308. [aRAD]
- Lavolette, S. R., Gallegos, R. A., Henriksen, S. J. & van der Kooy, D. (2004) Opiate state controls bi-directional reward signaling via GABA-A receptors in the ventral tegmental area. *Nature Neuroscience* 10:160–69. [aRAD]
- Le Moal, M. & Simon, H. (1991) Mesocorticolimbic dopaminergic network: Functional and regulatory roles. *Physiological Reviews* 71:155–234. [aRAD]
- Leckman, J. F. & Herman, A. (2002) Maternal behavior and developmental psychopathology. *Biological Psychiatry* 51:27–43. [JES]
- Leckman, J. F. & Mayes, L. (1998) Understanding developmental psychopathology: How useful are evolutionary accounts? *Journal of the Academy of Child and Adolescent Psychiatry* 37:1011–21. [JES]
- Leckman, J. F., Feldman, R., Swain, J. E., Eicher, V., Thompson, N. & Mayes, L. C. (2004) Primary parental preoccupations revisited: Circuits, genes, and the critical role of the environment. *Journal of Neural Transmission* 111:753–71. [JES]
- LeDoux, J. (1987) Emotion. In: *Handbook of physiology*, ed. V. Mountcastle. American Physiological Society. [aRAD]
- (1998) *The emotional brain*. Simon & Schuster. [aRAD]
- LeDoux, J., Cicchetti, P., Xagoraris, A. & Romanski, L. (1990) The lateral amygdaloid nucleus: Sensory interface of the amygdala in fear conditioning. *Journal of Neuroscience* 10:1062–69. [aRAD]
- Lee, A., Clancy, S. & Fleming, A. S. (1998) Mother rats bar-press for pups: Effects of lesions of the mpoa and limbic sites on maternal behavior and operant

- responding for pup-reinforcement. *Behavioural Brain Research* 100:15–31. [aRAD]
- Legradi, G., Rand, W., Hitz, S., Nillni, E., Jackson, I. & Lechan, R. (1996) Opiate withdrawal increases ProTRH gene expression in the ventrolateral column of the midbrain periaqueductal gray. *Brain Research* 729:10–19. [aRAD]
- Leone, P., Pocock, D. & Wise, R. A. (1991) Morphine–dopamine interaction: Ventral tegmental morphine increases nucleus accumbens dopamine release. *Pharmacology, Biochemistry and Behavior* 39:469–72. [aRAD]
- Lerman, C., Wileyto, E. P., Patterson, F., Rukstalis, M., Audrain-McGovern, J., Restine, S., Shields, P. G., Kaufmann, V., Redden, D., Benowitz, N. & Berrettini, W. H. (2004) The functional mu opioid receptor (OPRM1) Asn40Asp variant predicts short-term response to nicotine replacement therapy in a clinical trial. *Pharmacogenomics* 4:184–92. [MRM]
- Levine, D. S. (in press) Angels, devils, and censors in the brain. *Complexus* 3(3) [DSL]
- Levine, S. (2001) Primary social relationships influence the development of the hypothalamic-pituitary-adrenal axis in the rat. *Physiology and Behavior* 73:255–60. [CSC]
- Levy, F., Kendrick, K., Keverne, E., Piketty, V. & Poindron, P. (1992) Intracerebral oxytocin is important for the onset of maternal behavior in inexperienced ewes delivered under peridural anesthesia. *Behavioral Neuroscience* 106:427–32. [aRAD]
- Lewinsohn, P. M. (1974) A behavioral approach to depression. In: *The psychology of depression: Contemporary theory and research*, ed. R. J. Friedman & M. M. Katz. Wiley. [DAP]
- Lewinsohn, P. M., Mischel, W., Chaplin, W. & Barton, R. (1980) Social competence and depression: The role of illusory self-perceptions. *Journal of Abnormal Psychology* 89:203–12. [DAP]
- Leyton, M. & Stewart, J. (1992) The stimulation of central kappa opioid receptors decreases male sexual behavior and locomotor activity. *Brain Research* 594:56–74. [aRAD]
- Li, S., Cullen, W. K., Anwyl, R. & Rowan, M. J. (2003) Dopamine-dependent facilitation of LTP induction in hippocampal CA1 by exposure to spatial novelty. *Nature Neuroscience* 6:526–31. [aRAD]
- Lim, M. M., Hammock, E. A. D. & Young, L. J. (2004a) The role of vasopressin in the genetic and neural basis of monogamy. *Journal of Neuroendocrinology* 16:325–32. [CSC]
- Lim, M. M., Wang, Z. X., Olazabal, D. E., Ren, X. H., Terwilliger, E. F. & Young, L. J. (2004b) Enhanced partner preference in a promiscuous species by manipulating the expression of a single gene. *Nature* 429(6993):754–57. [CSC]
- Lindow, S. W., van der Spuy, Z. M., Hendricks, M. S., Nugent, F. A. & Dunne, T. T. (1993) The effect of morphine and naloxone administration on maternal oxytocin concentration in late pregnancy. *Clinical Endocrinology* 39:671–75. [aRAD]
- Liotti, M., Mayberg, H. S., McGinnis, S., Brannan, S. L. & Jerabek, P. (2002) Unmasking disease-specific cerebral blood flow abnormalities: Mood challenge in patients with remitted unipolar depression. *American Journal of Psychiatry* 159:1830–40. [DAP]
- Liste, I., Rozas, G., Guerra, M. J. & Labandeira-Garcia, J. L. (1995) Cortical stimulation induces fos expression in striatal neurons via NMDA glutamate and dopamine receptors. *Brain Research* 700(1–2):1–12. [aRAD]
- Lorberbaum, J. P., Newman, J. D., Horwitz, A. R., Dubno, J. R., Lydiard, R. B., Hamner, M. B., Bohning, D. E. & George, M. S. (2002) A potential role for thalamocingulate circuitry in human maternal behavior. *Biological Psychiatry* 51(6):431–45. [JES]
- Lorrain, D., Riolo, J., Matuszewich, S., Hull, E. (1999) Lateral hypothalamic serotonin inhibits nucleus accumbens dopamine: Implications for sexual satiety. *Journal of Neuroscience* 19:7648–52. [aRAD]
- Lu, W., Chen, H., Xue, C. & Wolf, M. (1997) Repeated amphetamine administration alters the expression of mRNA for AMPA receptor subunits in rat nucleus accumbens and prefrontal cortex. *Synapse* 26:269–78. [aRAD]
- Lucas, R. E., Diener, E., Grob, A., Suh, E. & Shao, L. (2000) Cross-cultural evidence for the fundamental features of extraversion. *Journal of Personality and Social Psychology* 79:452–68. [aRAD]
- Luciana, M., Collins, P. & Depue, R. (1998) Opposing roles for dopamine and serotonin modulation of visuospatial delayed-response performance. *Cerebral Cortex* 8:218–26. [rRAD]
- Lukas, J. H. & Siegel, J. (1977) Cortical mechanisms that augment or reduce evoked potentials in cats. *Science* 196:73–75. [MZ]
- Machado, C. J. & Bachevalier, J. (2003) Non-human primate models of childhood psychopathology: The promise and the limitations. *Journal of Child Psychology and Psychiatry* 44:64–87. [R-PB]
- MacLean, P. (1986) Ictal symptoms relating to the nature of affects and their cerebral substrate. In: *Emotion: Theory, research, and experience, vol. 3: Biological foundations of emotion*, ed. E. Plutchik & H. Kellerman. Academic Press. [aRAD]
- Maestro, S., Muratori, F., Cavallaro, M. C., Peo, F., Stern, D., Golse, B. & Palacios
- Espaca, F. (2002) Attentional skills during the first 6 months of age in autism spectrum disorder. *Journal of the American Academy of Child and Adolescent Psychiatry* 41:1239–45. [R-PB]
- Magee, J. & Johnston, D. (1997) Synaptically controlled, associative signal for Hebbian plasticity in hippocampal neurons. *Science* 275:209–13. [aRAD]
- Makin, J. W. & Porter, R. H. (1989) Attractiveness of lactating females' breast odors to neonates. *Child Development* 60:803–10. [aRAD]
- Malenka, R. & Nicoll, R. (1999) Long-term potentiation. A decade of progress? *Science* 285:1870–74. [aRAD]
- Maninger, N., Capitanio, J. P., Mendoza, S. P. & Mason W. A. (2003) Personality influences tetanus-specific antibody response in adult male rhesus macaques after removal from natal group and housing relocation. *American Journal of Primatology* 61:73–83. [TARW]
- Mann, P. E., Kinsley, C. H. & Bridges, R. S. (1991) Opioid receptor subtype involvement in maternal behavior in lactating rats. *Neuroendocrinology* 53:487–92. [aRAD, JES]
- Mann, P. E., Pasternak, G. W. & Bridges, R. S. (1990) Mu 1 opioid receptor involvement in maternal behavior. *Physiology and Behavior* 47:133–38. [SLB]
- Manson, J. H. (1994) Mating patterns, mate choice, and birth season heterosexual relationships in free-ranging rhesus macaques. *Primates* 35:417–33. [TARW]
- Mansour, A., Khachaturian, H., Lewis, M., Akil, H. & Watson, S. (1988) Anatomy of CNS opioid receptors. *Trends in Neuroscience* 11:308–314. [aRAD]
- Mao, J., Price, D. & Mayer, D. (1994) Thermal hyperalgesia in association with the development of morphine tolerance in rats: Roles of excitatory amino acid receptors and protein kinase C. *Journal of Neuroscience* 14:2301–12. [aRAD]
- Mao, J., Price, D., Phillips, L., Lu, J. & Mayer, D. (1995) Increase in protein kinase C gamma immunoreactivity in the spinal cord of rats associated with tolerance to the analgesic effects of morphine. *Brain Research* 677:257–67. [aRAD]
- Marinelli, M. & White, F. (2000) Enhanced vulnerability to cocaine self-administration is associated with elevated impulse activity of midbrain dopamine neurons. *Journal of Neuroscience* 20:8876–85. [aRAD]
- Mark, G., Blander, D. & Hoebel, B. (1991) A conditioned stimulus decreases extracellular dopamine content in the nucleus accumbens after the development of a learned taste aversion. *Brain Research* 511:308–23. [aRAD]
- Martel, F., Nevison, C., Rayment, F., Simpson, M. & Keverne, E. (1993) Opioid receptor blockade reduces maternal affect and social grooming in rhesus monkeys. *Psychoneuroendocrinology* 18:307–21. [aRAD]
- Martel, F., Nevison, C., Simpson, M. & Keverne, E. (1995) Effects of opioid receptor blockade on the social behavior of rhesus monkeys living in large family groups. *Developmental Psychobiology* 28:71–84. [aRAD]
- Martin, G., Nie, Z. & Siggins, G. (1997) μ -opioid receptors modulate NMDA receptor-mediated responses in nucleus accumbens neurons. *Journal of Neuroscience* 17:11–22. [aRAD]
- Martin, L., Hadfield, M., Dellovade, T. & Price, D. (1991) The striatal mosaic in primates: Patterns of neuropeptide immunoreactivity differentiate the ventral striatum from the dorsal striatum. *Neuroscience* 43:397–401. [aRAD]
- Martin-Soelch, C., Leenders, K., Chevalley, A., Missimer, J., Kunig, G., Magyar, S., Mino, A. & Schultz, W. (2001) Reward mechanisms in the brain and their role in dependence: Evidence from neurophysiological and neuroimaging studies. *Brain Research Reviews* 36:139–49. [aRAD]
- Mason, W. & Mendoza, S. (1998) Generic aspects of primate attachments: Parents, offspring and mates. *Psychoneuroendocrinology* 23:765–78. [aRAD]
- Mason, W. A. (1978) Social experience and primate cognitive development. In: *The development of behavior: Comparative and evolutionary aspects*, ed. G. M. Burghardt & M. Bekoff, pp. 233–251. Garland Press. [TARW]
- Mason, W. A. & Berkson, G. (1975) Effects of maternal mobility on the development of flocking and other behaviors in rhesus monkeys: A study with artificial mothers. *Developmental Psychobiology* 8:197–211. [TARW]
- Mason, W. A., Mendoza, S. P. & Moberg, G. P. (1991) Persistent effects of early social experience on physiological responsiveness. In: *Primate today*, ed. A. Ehara, pp. 469–471. Elsevier. [TARW]
- Matheson, M. D. & Bernstein, I. S. (2000) Grooming, social bonding, and agonistic aiding in rhesus monkeys. *American Journal of Primatology* 51:177–86. [aRAD, TARW]
- Matthes, H. W., Maldonado, R., Simonin, F., Valverde, O., Slowe, S., Kitchen, I., Befort, K., Dierich, A., Le Meur, M., Dolle, P., Tzavara, E., Hanoune, J., Roques, B. P. & Kieffer, B. L. (1996) Loss of morphine-induced analgesia, reward effect and withdrawal symptoms in mice lacking the μ -opioid-receptor gene. *Nature* 383:819–23. [aRAD]
- Mattson, M. (1988) Neurotransmitters in the regulation of neuronal cytoarchitecture. *Brain Research Reviews* 13:179–212. [aRAD]
- Mayer, A. D., Farris, P. L., Komisaruk, B. R. & Rosenblatt, J. S. (1985) Opiate antagonism reduces placental phagocytosis and pup cleaning by parturient rats. *Pharmacology, Biochemistry and Behavior* 22:1035–44. [JES]

- responding for pup-reinforcement. *Behavioural Brain Research* 100:15–31. [aRAD]
- Legradi, G., Rand, W., Hitz, S., Nillni, E., Jackson, I. & Lechan, R. (1996) Opiate withdrawal increases ProTRH gene expression in the ventrolateral column of the midbrain periaqueductal gray. *Brain Research* 729:10–19. [aRAD]
- Leone, P., Pocock, D. & Wise, R. A. (1991) Morphine–dopamine interaction: Ventral tegmental morphine increases nucleus accumbens dopamine release. *Pharmacology, Biochemistry and Behavior* 39:469–72. [aRAD]
- Lerman, C., Wileyto, E. P., Patterson, F., Rukstalis, M., Audrain-McGovern, J., Restine, S., Shields, P. G., Kaufmann, V., Redden, D., Benowitz, N. & Berrettini, W. H. (2004) The functional mu opioid receptor (OPRM1) Asn40Asp variant predicts short-term response to nicotine replacement therapy in a clinical trial. *Pharmacogenomics* 4:184–92. [MRM]
- Levine, D. S. (in press) Angels, devils, and censors in the brain. *Complexus* 3(3) [DSL]
- Levine, S. (2001) Primary social relationships influence the development of the hypothalamic-pituitary-adrenal axis in the rat. *Physiology and Behavior* 73:255–60. [CSC]
- Levy, F., Kendrick, K., Keverne, E., Piketty, V. & Poindron, P. (1992) Intracerebral oxytocin is important for the onset of maternal behavior in inexperienced ewes delivered under peridural anesthesia. *Behavioral Neuroscience* 106:427–32. [aRAD]
- Lewinsohn, P. M. (1974) A behavioral approach to depression. In: *The psychology of depression: Contemporary theory and research*, ed. R. J. Friedman & M. M. Katz. Wiley. [DAP]
- Lewinsohn, P. M., Mischel, W., Chaplin, W. & Barton, R. (1980) Social competence and depression: The role of illusory self-perceptions. *Journal of Abnormal Psychology* 89:203–12. [DAP]
- Leyton, M. & Stewart, J. (1992) The stimulation of central kappa opioid receptors decreases male sexual behavior and locomotor activity. *Brain Research* 594:56–74. [aRAD]
- Li, S., Cullen, W. K., Anwyl, R. & Rowan, M. J. (2003) Dopamine-dependent facilitation of LTP induction in hippocampal CA1 by exposure to spatial novelty. *Nature Neuroscience* 6:526–31. [aRAD]
- Lim, M. M., Hammock, E. A. D. & Young, L. J. (2004a) The role of vasopressin in the genetic and neural basis of monogamy. *Journal of Neuroendocrinology* 16:325–32. [CSC]
- Lim, M. M., Wang, Z. X., Olazabal, D. E., Ren, X. H., Terwilliger, E. F. & Young, L. J. (2004b) Enhanced partner preference in a promiscuous species by manipulating the expression of a single gene. *Nature* 429(6993):754–57. [CSC]
- Lindow, S. W., van der Spuy, Z. M., Hendricks, M. S., Nugent, F. A. & Dunne, T. T. (1993) The effect of morphine and naloxone administration on maternal oxytocin concentration in late pregnancy. *Clinical Endocrinology* 39:671–75. [aRAD]
- Liotti, M., Mayberg, H. S., McGinnis, S., Brannan, S. L. & Jerabek, P. (2002) Unmasking disease-specific cerebral blood flow abnormalities: Mood challenge in patients with remitted unipolar depression. *American Journal of Psychiatry* 159:1830–40. [DAP]
- Liste, I., Rozas, G., Guerra, M. J. & Labandeira-Garcia, J. L. (1995) Cortical stimulation induces fos expression in striatal neurons via NMDA glutamate and dopamine receptors. *Brain Research* 700(1–2):1–12. [aRAD]
- Lorberbaum, J. P., Newman, J. D., Horwitz, A. R., Dubno, J. R., Lydiard, R. B., Hamner, M. B., Bohning, D. E. & George, M. S. (2002) A potential role for thalamocingulate circuitry in human maternal behavior. *Biological Psychiatry* 51(6):431–45. [JES]
- Lorrain, D., Riolo, J., Matuszewich, S., Hull, E. (1999) Lateral hypothalamic serotonin inhibits nucleus accumbens dopamine: Implications for sexual satiety. *Journal of Neuroscience* 19:7648–52. [aRAD]
- Lu, W., Chen, H., Xue, C. & Wolf, M. (1997) Repeated amphetamine administration alters the expression of mRNA for AMPA receptor subunits in rat nucleus accumbens and prefrontal cortex. *Synapse* 26:269–78. [aRAD]
- Lucas, R. E., Diener, E., Grob, A., Suh, E. & Shao, L. (2000) Cross-cultural evidence for the fundamental features of extraversion. *Journal of Personality and Social Psychology* 79:452–68. [aRAD]
- Luciana, M., Collins, P. & Depue, R. (1998) Opposing roles for dopamine and serotonin modulation of visuospatial delayed-response performance. *Cerebral Cortex* 8:218–26. [rRAD]
- Lukas, J. H. & Siegel, J. (1977) Cortical mechanisms that augment or reduce evoked potentials in cats. *Science* 196:73–75. [MZ]
- Machado, C. J. & Bachevalier, J. (2003) Non-human primate models of childhood psychopathology: The promise and the limitations. *Journal of Child Psychology and Psychiatry* 44:64–87. [R-PB]
- MacLean, P. (1986) Ictal symptoms relating to the nature of affects and their cerebral substrate. In: *Emotion: Theory, research, and experience, vol. 3: Biological foundations of emotion*, ed. E. Plutchik & H. Kellerman. Academic Press. [aRAD]
- Maestro, S., Muratori, F., Cavallaro, M. C., Peo, F., Stern, D., Golse, B. & Palacios
- Espaca, F. (2002) Attentional skills during the first 6 months of age in autism spectrum disorder. *Journal of the American Academy of Child and Adolescent Psychiatry* 41:1239–45. [R-PB]
- Magee, J. & Johnston, D. (1997) Synaptically controlled, associative signal for Hebbian plasticity in hippocampal neurons. *Science* 275:209–13. [aRAD]
- Makin, J. W. & Porter, R. H. (1989) Attractiveness of lactating females' breast odors to neonates. *Child Development* 60:803–10. [aRAD]
- Malenka, R. & Nicoll, R. (1999) Long-term potentiation. A decade of progress? *Science* 285:1870–74. [aRAD]
- Maninger, N., Capitanio, J. P., Mendoza, S. P. & Mason W. A. (2003) Personality influences tetanus-specific antibody response in adult male rhesus macaques after removal from natal group and housing relocation. *American Journal of Primatology* 61:73–83. [TARW]
- Mann, P. E., Kinsley, C. H. & Bridges, R. S. (1991) Opioid receptor subtype involvement in maternal behavior in lactating rats. *Neuroendocrinology* 53:487–92. [aRAD, JES]
- Mann, P. E., Pasternak, G. W. & Bridges, R. S. (1990) Mu 1 opioid receptor involvement in maternal behavior. *Physiology and Behavior* 47:133–38. [SLB]
- Manson, J. H. (1994) Mating patterns, mate choice, and birth season heterosexual relationships in free-ranging rhesus macaques. *Primates* 35:417–33. [TARW]
- Mansour, A., Khachaturian, H., Lewis, M., Akil, H. & Watson, S. (1988) Anatomy of CNS opioid receptors. *Trends in Neuroscience* 11:308–314. [aRAD]
- Mao, J., Price, D. & Mayer, D. (1994) Thermal hyperalgesia in association with the development of morphine tolerance in rats: Roles of excitatory amino acid receptors and protein kinase C. *Journal of Neuroscience* 14:2301–12. [aRAD]
- Mao, J., Price, D., Phillips, L., Lu, J. & Mayer, D. (1995) Increase in protein kinase C gamma immunoreactivity in the spinal cord of rats associated with tolerance to the analgesic effects of morphine. *Brain Research* 677:257–67. [aRAD]
- Marinelli, M. & White, F. (2000) Enhanced vulnerability to cocaine self-administration is associated with elevated impulse activity of midbrain dopamine neurons. *Journal of Neuroscience* 20:8876–85. [aRAD]
- Mark, G., Blander, D. & Hoebel, B. (1991) A conditioned stimulus decreases extracellular dopamine content in the nucleus accumbens after the development of a learned taste aversion. *Brain Research* 511:308–23. [aRAD]
- Martel, F., Nevison, C., Rayment, F., Simpson, M. & Keverne, E. (1993) Opioid receptor blockade reduces maternal affect and social grooming in rhesus monkeys. *Psychoneuroendocrinology* 18:307–21. [aRAD]
- Martel, F., Nevison, C., Simpson, M. & Keverne, E. (1995) Effects of opioid receptor blockade on the social behavior of rhesus monkeys living in large family groups. *Developmental Psychobiology* 28:71–84. [aRAD]
- Martin, G., Nie, Z. & Siggins, G. (1997) μ -opioid receptors modulate NMDA receptor-mediated responses in nucleus accumbens neurons. *Journal of Neuroscience* 17:11–22. [aRAD]
- Martin, L., Hadfield, M., Dellovade, T. & Price, D. (1991) The striatal mosaic in primates: Patterns of neuropeptide immunoreactivity differentiate the ventral striatum from the dorsal striatum. *Neuroscience* 43:397–401. [aRAD]
- Martin-Soelch, C., Leenders, K., Chevalley, A., Missimer, J., Kunig, G., Magyar, S., Mino, A. & Schultz, W. (2001) Reward mechanisms in the brain and their role in dependence: Evidence from neurophysiological and neuroimaging studies. *Brain Research Reviews* 36:139–49. [aRAD]
- Mason, W. & Mendoza, S. (1998) Generic aspects of primate attachments: Parents, offspring and mates. *Psychoneuroendocrinology* 23:765–78. [aRAD]
- Mason, W. A. (1978) Social experience and primate cognitive development. In: *The development of behavior: Comparative and evolutionary aspects*, ed. G. M. Burghardt & M. Bekoff, pp. 233–251. Garland Press. [TARW]
- Mason, W. A. & Berkson, G. (1975) Effects of maternal mobility on the development of flocking and other behaviors in rhesus monkeys: A study with artificial mothers. *Developmental Psychobiology* 8:197–211. [TARW]
- Mason, W. A., Mendoza, S. P. & Moberg, G. P. (1991) Persistent effects of early social experience on physiological responsiveness. In: *Primate today*, ed. A. Ehara, pp. 469–471. Elsevier. [TARW]
- Matheson, M. D. & Bernstein, I. S. (2000) Grooming, social bonding, and agonistic aiding in rhesus monkeys. *American Journal of Primatology* 51:177–86. [aRAD, TARW]
- Matthes, H. W., Maldonado, R., Simonin, F., Valverde, O., Slowe, S., Kitchen, I., Befort, K., Dierich, A., Le Meur, M., Dolle, P., Tzavara, E., Hanoune, J., Roques, B. P. & Kieffer, B. L. (1996) Loss of morphine-induced analgesia, reward effect and withdrawal symptoms in mice lacking the μ -opioid-receptor gene. *Nature* 383:819–23. [aRAD]
- Mattson, M. (1988) Neurotransmitters in the regulation of neuronal cytoarchitecture. *Brain Research Reviews* 13:179–212. [aRAD]
- Mayer, A. D., Farris, P. L., Komisaruk, B. R. & Rosenblatt, J. S. (1985) Opiate antagonism reduces placentophagia and pup cleaning by parturient rats. *Pharmacology, Biochemistry and Behavior* 22:1035–44. [JES]

- McAdams, D. P. (1982) Intimacy motivation. In: *Motivation and society*, ed. A. J. Stewart. Jossey-Bass. [DSL]
- McAdams, D. P., Healy, S. & Krause, S. (1984) Social motives and patterns of friendship. *Journal of Personality and Social Psychology* 47:828–38. [DSL]
- McCall, M., Wand, G., Eissenberg, T., Rohde, C. & Cheskin, L. (2000a) Naltrexone alters subjective and psychomotor responses to alcohol in heavy drinking subjects. *Neuropsychopharmacology* 22:480–92. [aRAD]
- McCall, M., Wand, G., Rohde, C. & Lee, S. (2000b) Serum 6-beta-naltrexol levels are related to alcohol responses in heavy drinkers. *Alcoholism: Clinical and Experimental Research* 24:1385–91. [aRAD]
- McCarthy, M. M. (1995) Estrogen modulation of oxytocin and its relation to behavior. In: *Oxytocin*, ed. R. Ivell & J. Ressell. Plenum. [aRAD]
- McCarthy, M. M. & Altemus, M. (1997) Central nervous system actions of oxytocin and modulation of behavior in humans. *Molecular Medicine Today* 15:269–75. [aRAD]
- McCarthy, M. M., Kow, L. & Pfaff, D. (1992) Speculations concerning the physiological significance of central oxytocin in maternal behavior. *Annals of the New York Academy of Science* 652:70–82. [aRAD]
- McCaul, M., Wand, G., Stuffer, R., Lee, S. & Rohde, C. (2001) Naltrexone dampens ethanol-induced cardiovascular and hypothalamic-pituitary-adrenal axis activation. *Neuropsychopharmacology* 25:537–47. [aRAD]
- McDonald, A., Shammah-Lagnado, S., Shi, C. & Davis, M. (1999) Cortical afferents to the extended amygdala. In: *Advancing from the ventral striatum to the extended amygdala*, ed. J. F. McGinty. *Annals of the New York Academy of Sciences* 877:309–38. [aRAD]
- McGaugh, J. (2000) Memory: A century of consolidation. *Science* 287:248–51. [aRAD]
- McGinty, J. F. (1999) Regulation of neurotransmitter interactions in the ventral striatum. In: *Advancing from the ventral striatum to the extended amygdala*, ed. J. F. McGinty. *Annals of the New York Academy of Sciences* 877:129–39. [aRAD]
- McGuire, M. T. & Troisi, A. (1998) *Darwinian psychiatry*. Oxford University Press. [AT]
- McLoyd, V. (1998) Socioeconomic disadvantage and child development. *American Psychologist* 53:185–204. [aRAD]
- McNaughton, N. (1989) *Biology and emotion*. Cambridge University Press. [aRAD]
- McPhail, C. & Wohlstein, R. T. (1983) Individual and collective behavior within gatherings, demonstrations and riots. *Annual Review of Sociology* 9:579–600. [MG]
- Mead, G. (1956) *The social psychology of George Herbert Mead*, ed. Anselm Strauss. University of Chicago Press. [MG]
- Meaney, M. (2001) Maternal care, gene expression, and the transmission of individual differences in stress reactivity across generations. *Annual Review of Neuroscience* 24:1161–92. [aRAD]
- Meehl, P. E. (1975) Hedonic capacity: Some conjectures. *Bulletin of the Menninger Clinic* 38:295–307. [DAP]
- Mehlman, P. T., Higley, J. D., Faucher, I., Lilly, A. A., Taub, D. M., Vickers, J., Suomi, S. J. & Linnoila, M. (1995) Correlation of CSF-5HIAA concentration with sociality and the timing of emigration in free-ranging primates. *American Journal of Psychiatry* 152:907–13. [DJZ]
- Meisel, R., Camp, D. & Robinson, T. (1993) A microdialysis study of ventral striatal dopamine during sexual behavior in female Syrian hamsters. *Behavioural Brain Research* 55:151–57. [aRAD]
- Meisel, R. & Joppa, M. (1996) Conditioned place preference in female hamsters following aggressive or sexual encounters. *Physiology and Behavior* 56:1115–18. [aRAD]
- Menkens, K., Bilsky, E., Wild, K., Portoghese, P., Reid, L. & Porreca, F. (1992) Cocaine place preference is blocked by the δ -opioid receptor antagonist, naltrindole. *European Journal of Pharmacology* 219:345–46. [aRAD]
- Meredith, G. & Totterdell, S. (1999) Microcircuits in nucleus accumbens' shell and core involved in cognition and reward. *Psychobiology* 27:165–86. [aRAD]
- Meredith, G. E., Pennartz, C. M. & Groenewegen, H. J. (1993) The cellular framework for chemical signalling in the nucleus accumbens. *Progress in Brain Research* 99:3–24. [aRAD]
- Mermelstein, P. & Becker, J. (1995) Increased extracellular dopamine in the nucleus accumbens and striatum of the female rat during paced copulatory behavior. *Behavioral Neuroscience* 109:354–65. [aRAD]
- Mesulam, M. (1990) Large-scale neurocognitive networks and distributed processing for attention, language, and memory. *Annals of Neurology* 28:597–613. [aRAD]
- Michelini, S., Urbaneck, M., Dean, M. & Goldman, D. (1995) Polymorphism and genetic mapping of the human oxytocin receptor gene on chromosome 3. *American Journal of Medical Genetics (Neuropsychiatric Genetics)* 60:183–87. [aRAD]
- Miller, W. B. & Rodgers, J. L. (2001) *The ontogeny of human bonding systems: Evolutionary origins, neural bases, and psychological manifestations*. Kluwer. [WBM]
- Mirenovic, J. & Schultz, W. (1996) Preferential activation of midbrain dopamine neurons by appetitive rather than aversive stimuli. *Nature* 379:449–51. [aRAD, PO]
- Mishkin, M. (1982) A memory system in the monkey. *Philosophical Transactions of the Royal Society of London B* 298:85–95. [aRAD]
- Mitani, J. (1985) Mating behaviour of male orangutans in the Kutai Game Reserve, Indonesia. *Animal Behaviour* 33:392–402. [TARW]
- Mitchell, J. & Gratton, A. (1992a) Partial dopamine depletion of the prefrontal cortex leads to enhanced mesolimbic dopamine release elicited by repeated exposure to naturally reinforcing stimuli. *Journal of Neuroscience* 12:3609–14. [aRAD]
- (1992b) Mesolimbic dopamine release elicited by activation of the accessory olfactory system: A high speed chronoamperometric study. *Neuroscience Letters* 140:81–84. [aRAD]
- Mitchell, J. B. & Gratton, A. (1991) Opioid modulation and sensitization of dopamine release elicited by sexually relevant stimuli: A high speed chronoamperometric study in freely behaving rats. *Brain Research* 551:20–27. [aRAD]
- Modahl, C., Green, L. A., Fein, D., Waterhouse, L., Feinstein, C., Morris, M. & Levin, H. (1998) Plasma oxytocin levels in autistic children. *Biological Psychiatry* 43:270–77. [R-PB]
- Modney, B. & Hatton, G. (1991) Motherhood modifies magnocellular neuronal interrelationships in functionally meaningful ways. In: *Mammalian parenting*, ed. N. Krasheg & R. Bridges. Oxford University Press. [aRAD]
- Mogenson, G., Grudzynski, S., Wu, M., Yang, C. & Yim, C. (1993) From motivation to action. In: *Limbic motor circuits and neuropsychiatry*, ed. P. Kalivas & C. Barnes. CRC Press. [aRAD]
- Mogil, J. S., Wilson, S. G., Bon, K., Lee, S. E., Chung, K., Raber, P., Pieper, J. O., Hain, H. S., Belknap, J. K., Hubert, L., Elmer, G. I., Chung, J. M. & Devor, M. (1999a) Heritability of nociception I: Responses of 11 inbred mouse strains on 12 measures of nociception. *Pain* 80:67–82. [aRAD]
- (1999b) Heritability of nociception, II: "Types" of nociception revealed by genetic correlation analysis. *Pain* 80:83–93. [aRAD]
- Moles, A., Kieffer, B. L. & D'Amato, F. R. (2004) Deficit in attachment behavior in mice lacking the μ -opioid receptor gene. *Science* 304:1983–86. [rRAD, JP, JES, AT]
- Montague, P. R. & Berns, G. S. (2002) Neural economics and the biological substrates of valuation. *Neuron* 36:265–84. [DJZ]
- Morgan, H., Fleming, A. & Stern, J. (1992) Somatosensory control of the onset and retention of maternal responsiveness in primiparous Sprague-Dawley rats. *Physiology and Behavior* 51:541–55. [aRAD]
- Morris, J., Friston, K. & Dolan, R. (1997) Neural responses to salient visual stimuli. *Proceedings of the Royal Society of London Bulletin of Biological Science* 264:769–75. [aRAD]
- Morrone, J. V., Depue, R. A., Scherer, A. J. & White, T. L. (2000) Film-induced incentive motivation and positive activation in relation to agentic and affiliative components of extraversion. *Personality and Individual Differences* 29(2):199–216. [aRAD]
- Morrone-Strupinsky, J. & Depue, R. (2004) Differential relation of two distinct, film-induced positive emotional states to affiliative and agentic extraversion. *Personality and Individual Differences* 36:1109–26. [aRAD]
- Moskowitz, D. S. (1994) Cross-situational generality and the interpersonal circumplex. *Journal of Personality and Social Psychology* 66:921–33. [SNY]
- Moskowitz, D. S., Pinard, G., Zuroff, D. C., Annable, L. & Young, S. N. (2001) The effect of tryptophan on social interaction in every day life: A placebo-controlled study. *Neuropsychopharmacology* 25:277–89. [SNY]
- Mucha, R., Van der Kooy, D., O'Shaughnessy, M. & Buceniekis, P. (1982) Drug reinforcement studies by the use of place conditioning in the rat. *Brain Research* 243:91–105. [aRAD]
- Munafò, M. R., Clark, T. G. & Flint, J. (2005a) Does measurement instrument moderate the association between the serotonin transporter gene and anxiety-related personality traits? A meta-analysis. *Molecular Psychiatry* 10(4):415–19. [MRM]
- Munafò, M. R., Roberts, K., Johnstone, E. C., Walton, R. & Yudin, P. (2005b) Association of serotonin transporter gene polymorphism with nicotine dependence: No evidence for an interaction with trait neuroticism. *Personality and Individual Differences* 38:843–850. [MRM]
- Munafò, M. R., Clark, T. G., Johnstone, E. C., Murphy, M. F. G. & Walton, R. (2004) The genetic basis for smoking behaviour: A systematic review and meta-analysis. *Nicotine and Tobacco Research* 6:583–97. [MRM]
- Munafò, M. R., Clark, T. G., Moore, L. R. Payne, E., Walton, R. & Flint J. (2003) Genetic polymorphisms and personality: A systematic review and meta-analysis. *Molecular Psychiatry* 8:471–84. [rRAD, MRM]
- Murray, H. D. (1938) *Explorations in personality*. Harvard University Press. [WBM]
- Nakamichi, M. (1989) Sex differences in social development during the first 4 years in a free-ranging group of Japanese monkeys *Macaca-Fuscata*. *Animal Behaviour* 38(5):737–48. [TARW]
- Nakamichi, M. & Shizawa, Y. (2003) Distribution of grooming among adult females

- in a large, free-ranging group of Japanese macaques. *International Journal of Primatology* 24(3):607–25. [TARW]
- Narita, M., Aoki, T. & Suzuki, T. (2000) Molecular evidence for the involvement of NR2B subunit containing N-methyl-D-aspartate receptors in the development of morphine-induced place preference. *Neuroscience* 101:601–06. [aRAD]
- Narita, M., Mizuo, K., Mizoguchi, H., Sakata, M., Narita, M., Tseng, L. F. & Tsutomu, S. (2003) Molecular evidence for the functional role of dopamine D3 receptor in the morphine-induced rewarding effect and hyperlocomotion. *Journal of Neuroscience* 23:1006–21. [aRAD]
- Nauta, W. J. H. & Feirtag, M. (1986) *Fundamental Neuroanatomy*. W. H. Freeman. [aRAD]
- Nelson, E. & Panksepp, J. (1996) Oxytocin mediates acquisition of maternally associated odor preferences in preweanling rat pups. *Behavioral Neuroscience* 110(3):583–92. [aRAD]
- Nelson, E. E. & Panksepp, J. (1998) Brain substrates of infant–mother attachment: Contributions of opioids, oxytocin, and norepinephrine. *Neuroscience and Biobehavioral Reviews* 22(3):437–52. [aRAD, JP, JES]
- Nestler, E. & Aghajanian, G. (1997) Molecular and cellular basis of addiction. *Science* 278:58–63. [aRAD]
- Netter, P., Hennig, J. & Roed, I. (1996) Serotonin and dopamine as mediators of sensation seeking behavior. *Neuropsychobiology* 34:155–65. [aRAD]
- Newman, S. W. (1999) The medial extended amygdala in male reproductive behavior: A node in the mammalian social behavior network. In: *Advancing from the ventral striatum to the extended amygdala*, ed. J. F. McGinty. *Annals of the New York Academy of Sciences* 877:242–57. [aRAD]
- Niesink, R. J. M., Vanderschueren, L. J. M. J. & van Ree, J. M. (1996) Social play in juvenile rats with in utero exposure to morphine. *NeuroToxicology* 17(3–4):905–12. [aRAD]
- Niesink, R. & van Ree, J. (1989) Involvement of opioid and dopaminergic systems in isolation-induced pinning and social grooming of young rats. *Neuropharmacology* 28:411–18. [aRAD]
- Nishimori, K., Young, L. J., Guo, Q., Wang, Z., Insel, T. R. & Matzuk, M. M. (1996) Oxytocin is required for nursing but is not essential for parturition or reproductive behavior. *Proceedings of the National Academy of Sciences USA* 93:11699–704. [aRAD]
- Nishino, H., Taketoshi, O., Muramoto, K., Fukuda, M. & Sasaki, K. (1987) Neuronal activity in the ventral tegmental area (VTA) during motivated bar press feeding in the monkey. *Brain Research* 413:302–13. [aRAD]
- Nissen, E., Gustavsson, P., Widstrom, A.-M. & Uvnas-Moberg, K. (1998) Oxytocin, prolactin, milk production and their relationship with personality traits in women after vaginal delivery or Cesarean section. *Journal of Psychosomatic Obstetrics and Gynecology* 19:49–58. [aRAD]
- Nissen, E., Uvnas-Moberg, K., Svensson, K., Stock, S., Widstrom, A.-M. & Winberg, J. (1996) Different patterns of oxytocin, prolactin, but not cortisol release during breastfeeding in women who delivered by Cesarean section or by the vaginal route. *Early Human Development* 45:103–18. [aRAD]
- Nitschke, J. B., Nelson, E. E., Rusch, B. D., Fox, A. S., Oakes, T. R. & Davidson, R. J. (2004) Orbitofrontal cortex tracks positive mood in mothers viewing pictures of their newborn infants. *NeuroImage* 21(2):583–92. [JES]
- Numan, M. (1988) Neural basis of maternal behavior in rats. *Psychoneuroendocrinology* 13:47–62. [SLB]
- Numan, M. & Sheehan, T. P. (1997) Neuroanatomical circuitry for mammalian maternal behavior. *Annals of the New York Academy of Sciences* 807:101–25. [JES]
- Ochsner, K. N. & Gross, J. J. (2004) Thinking makes it so: A social cognitive neuroscience approach to emotion regulation. In: *Handbook of self-regulation: Research, theory, and applications*, ed. R. Baumeister & K. Vohs, pp. 229–255. Guilford. [SLB]
- O'Doherty, J., Kringelbach, M., Rolls, E., Hornack, J. & Andrews, C. (2001) Abstract reward and punishment representations in the human orbitofrontal cortex. *Nature Neuroscience* 4:95–102. [aRAD]
- O'Donnell, P. (1999) Ensemble coding in the nucleus accumbens. *Psychobiology* 27(2):187–97. [aRAD]
- (2003) Dopamine gating of forebrain neural ensembles. *European Journal of Neuroscience* 17:429–35. [PO]
- O'Donnell, P. & Grace, A. A. (1995) Synaptic interactions among excitatory afferents to nucleus accumbens neurons: Hippocampal gating of prefrontal cortical input. *Journal of Neuroscience* 15:3622–39. [PO]
- O'Donnell, P., Pabello, N., Lewis, B. L. & Grace, A. A. (1999) Modulation of cell firing in the nucleus accumbens. In: *Advancing from the ventral striatum to the extended amygdala*, ed. J. F. McGinty. *Annals of the New York Academy of Sciences* 877:157–75. [aRAD]
- Olausson, H., Lamarre, Y., Backlund, H., Morin, C., Wallin, B. G., Starck, G., Ekholm, S., Strigo, I., Worsley, K., Vallbo, A. B. & Bushnell, M. C. (2002) Unmyelinated tactile afferents signal touch and project to insular cortex. *Nature Neuroscience* 5:900–04. [aRAD]
- Oldenburger, W., Everitt, B. & de Jonge, F. (1992) Conditioned place preference induced by sexual interaction in female rats. *Hormones and Behavior* 26:214–28. [aRAD]
- Olds, M. (1982) Reinforcing effects of morphine in the nucleus accumbens. *Brain Research* 237:429–40. [aRAD]
- Olive, M., Koenig, H., Nannini, M. & Hodge, C. (2001) Stimulation of endorphin neurotransmission in the nucleus accumbens by ethanol, cocaine, and amphetamine. *Journal of Neuroscience* 21(RC 184):1–5. [aRAD]
- Olmstead, M. & Franklin, K. (1997) The development of a conditioned place preference to morphine effects of microinjections into various CNS sites. *Behavioral Neuroscience* 111:1324–34. [aRAD]
- Olmstead, M., Munn, E. M., Franklin, K. & Wise, R. A. (1999) Effects of pedunculopontine tegmental nucleus lesions on responding for intravenous heroin under different schedules of reinforcement. *Journal of Neuroscience* 18:5035–44. [aRAD]
- Olson, G., Olson, R. & Kastin, A. (1997) Endogenous opiates: 1996. *Peptides* 18:1651–88. [aRAD]
- Ongur, D. & Price, J. (2000) The organization of networks within the orbital and medial prefrontal cortex of rats, monkeys and humans. *Cerebral Cortex* 10:206–19. [aRAD]
- Orpen, B. & Fleming, A. (1987) Experience with pups sustains maternal responding in postpartum rats. *Physiology & Behavior* 40:47–54. [aRAD]
- Ostrowski, N. L. (1998) Oxytocin receptor mRNA expression in rat brain: Implications for behavioral integration and reproductive success. *Psychoneuroendocrinology* 23(8):989–1004. [aRAD]
- Panagis, G., Kastellakis, A. & Spyrali, G. (1998) Involvement of the ventral tegmental area opiate receptors in self-stimulation elicited from the ventral pallidum. *Psychopharmacology* 139:222–29. [aRAD]
- Panksepp, J. (1981) Brain opioids: A neurochemical substrate for narcotic and social dependence. In: *Progress in theory in psychopharmacology*, ed. S. Cooper, pp. 149–175. Academic Press. [JP, JES]
- (1986) The anatomy of emotions. In: *Emotion: Theory, research, and experience*, vol 3: *Biological foundations*, ed. E. Plutchik & H. Kellerman. Academic. [aRAD]
- (1998) *Affective neuroscience: The foundations of human and animal emotions*. Oxford University Press. [aRAD, DSL, WBM, PN, JP]
- (2003) Can anthropomorphic analyses of “separation cries” in other animals inform us about the emotional nature of social loss in humans? *Psychological Reviews* 110:376–88. [JP]
- Panksepp, J. & Bishop, P. (1981) An autoradiographic map of 3H diprenorphine binding in the rat brain: Effects of social interaction. *Brain Research Bulletin* 7:405–10. [JP]
- Panksepp, J. & Harro, J. (2004) The future of neuropeptides in biological psychiatry and emotional psychopharmacology: Goals and strategies. In: *Textbook of Biological Psychiatry*, ed. J. Panksepp, pp. 627–660. Wiley. [JP]
- Panksepp, J., Herman, B., Conner, R., Bishop, P. & Scott, J. P. (1978) The biology of social attachments: Opiates alleviate separation distress. *Biological Psychiatry* 9:213–20. [JP]
- Panksepp, J., Herman, B. H., Vilberg, T., Bishop, P. & DeEsquinazi, F. G. (1980) Endogenous opioids and social behavior. *Neuroscience and Biobehavioral Reviews* 4:473–87. [rRAD, PN, JP]
- Panksepp, J., Jalowiec, J., DeEsquinazi, F. G. & Bishop, P. (1985) Opiates and play dominance in juvenile rats. *Behavioral Neuroscience* 99:441–53. [JP]
- Panksepp, J., Moskal, J., Panksepp, J. B. & Kroes, R. (2002) Comparative approaches in evolutionary psychology: Molecular neuroscience meets the mind. *Neuroendocrinology Letters* 23(Suppl. 4):105–115. [JP]
- Panksepp, J., Nelson, E. & Bekkedal, M. (1997) Brain systems for the mediation of social separation-distress and social-reward: Evolutionary antecedents and neuropeptide intermediaries. In: *The integrative neurobiology of affiliation*, ed. C. S. Carter, I. I. Lederhendler & B. Kirkpatrick. *New York Academy of Sciences* 875:344–67. [aRAD]
- Panksepp, J., Nelson, E. & Sivy, S. (1994) Brain opioids and mother-infant social motivation. *Acta Paediatrica* (Supplement) 397:40–46. [aRAD, JES]
- Panksepp, J., Newman, J. D. & Insel, T. R. (1992) Critical conceptual issues in the analysis of separation distress systems of the brain. In: *International review of studies on emotion*, vol. 2, ed. K. T. Strongman, pp. 51–72. Wiley. [JP]
- Panksepp, J., Sivy, S. M. & Normansell, L. A. (1985) Brain opioids and social emotions. In: *The psychobiology of attachment and separation*, ed. M. Reite & T. Fields. Academic Press. [JP]
- Paredes, R. & Alonso, A. (1997) Sexual behavior regulated (paced) by the female induces conditioned place preference. *Behavioral Neuroscience* 111:123–28. [aRAD]
- Pedersen, C. (1997) Oxytocin control of maternal behavior. Regulation by sex steroids and offspring stimuli. *Annals of the New York Academy of Sciences* 807:126–45. [aRAD]
- (2004) How love evolved from sex and gave birth to intelligence and human nature. *Journal of Bioeconomics*. 6(1):39–63. [PJZ]
- Pedersen, C. A., Caldwell, J. D., Jirkowski, G. F. & Insel, T. R., eds. (1992)

- Oxytocin in maternal, sexual and social behavior. *Annals of the New York Academy of Sciences* 652:1–492. [JP]
- Pederson, C. A., Caldwell, J. D., Walker, C., Ayers, G. & Mason, G. A. (1994) Oxytocin activates the postpartum onset of rat maternal behavior in the ventral tegmental and preoptic areas. *Behavioral Neuroscience* 108:1163–71. [JES]
- Pennington, B. F. & Ozonoff, S. (1996) Executive functions and developmental psychopathology. *Journal of Child Psychology and Psychiatry* 37:51–87. [R-PB]
- Pert, A., Post, R. & Weiss, S. (1992) Conditioning as a critical determinant of sensitization induced by psychomotor stimulants. In: *Neurobiology of drug abuse: Learning and memory*, ed. L. Erinoff. National Institute of Drug Abuse. [aRAD]
- Petraglia, F., Biraldi, M., Guarre, G., Facchinetti, F., Santino, M., Volpe, A. & Genazzini, R. (1985) Opioid peptides of the pituitary and hypothalamus: Change in pregnant and lactating rats. *Journal of Endocrinology* 105:239–45. [aRAD]
- Pettit, H., Ettenber, A., Bloom, F. & Koob, G. (1984) Destruction of dopamine in the nucleus accumbens selectively attenuates cocaine but not heroin self-administration in rats. *Psychopharmacology* 84:167–73. [aRAD]
- Pfaff, D. (1999) *Drive: Neurobiological and molecular mechanisms of sexual motivation*. MIT Press. [aRAD]
- Pfaus, J., Damsma, G., Nomikos, G., Wikstern, D., Blaha, C., Phillips, A. & Fibiger, H. (1990) Sexual behavior enhances central dopamine transmission in the male rat. *Brain Research* 530:345–57. [aRAD]
- Pfaus, J. G., Damsma, G., Wenkstern, D. & Fibiger, H. C. (1995) Sexual activity increases dopamine transmission in the nucleus accumbens and striatum of female rats. *Brain Research* 693:21–30. [aRAD]
- Pfaus, J. G., Smith, W. J. & Coopersmith, C. B. (1999) Appetitive and consummatory sexual behaviors of female rats in bilevel chambers: I. A correlational and factor analysis and the effects of ovarian hormones. *Hormones and Behavior* 35:224–40. [aRAD]
- Pfeiffer, A., Pasi, A., Mahraein, P. & Herz, A. (1982) Opiate receptor binding sites in the human brain. *Brain Research* 248:87–96. [aRAD]
- Phillips, A. & Fibiger, H. (1978) The role of dopamine in maintaining intracranial self-stimulation in the ventral tegmentum, nucleus accumbens and medial prefrontal cortex. *Reviews of Canadian Psychology* 32:58–66. [aRAD]
- Piazza, P. & Le Moal, M. (1996) Pathophysiological basis of vulnerability to drug abuse: Role of an interaction between stress, glucocorticoids, and dopaminergic neurons. *Annual Review of Pharmacology and Toxicology* 36:359–78. [aRAD]
- Pich, E., Pagliusi, S., Tessari, M., Talabot-Ayer, D., van Huijsduijnen, R. & Chiamulera, C. (1997) Common neural substrates for the addictive properties of nicotine and cocaine. *Science* 275:83–86. [aRAD]
- Pierce, K. & Courchesne, E. (2001) Evidence for a cerebellar role in reduced exploration and stereotyped behaviour in autism. *Biological Psychiatry* 49:655–64. [R-PB]
- Pierce, R. & Kalivas, P. (1995) Amphetamine produces sensitized increases in locomotion and extracellular dopamine preferentially in the nucleus accumbens shell of rats administered repeated cocaine. *Journal of Pharmacology and Experimental Therapeutics* 275:1019–29. [aRAD]
- Pierce, R., Bell, K., Duffy, P. & Kalivas, P. (1996) Repeated cocaine augments excitatory amino acid transmission in the nucleus accumbens only in rats having developed behavioral sensitization. *Journal of Neuroscience* 16:1550–60. [aRAD]
- Pintar, J. E. & Scott, R. E. M. (1993) Ontogeny of mammalian opioid systems. In: *Opioids I: Handbook of experimental pharmacology, vol. 104*, ed. A. Herz. Springer-Verlag. [aRAD]
- Pizzagalli, D. A., Oakes, T. R., Fox, A. S., Chung, M. K., Larson, C. L., Abercrombie, H. C., Schaefer, S. M., Benca, R. M. & Davidson, R. J. (2004) Functional but not structural subgenual prefrontal cortex abnormalities in melancholia. *Molecular Psychiatry* 9:393–405. [DAP]
- Ploeger, G., Willems, A. & Cools, A. (1991) Role of the nucleus accumbens in social memory in rats. *Brain Research Bulletin* 26:23–27. [aRAD]
- Polan, H. J. & Hofer, M. A. (1998) Olfactory preference for mother over home nest shavings by newborn rats. *Developmental Psychobiology* 33:5–20. [aRAD]
- Ponce, G., Jimenez-Arriero, M. A., Rubio, G., Hoenicka, J., Ampuero, I., Ramos, J. A. & Palomo, T. (2003) The A1 allele of the DRD2 gene (Tag1A polymorphisms) is associated with antisocial personality in a sample of alcohol-dependent patients. *European Psychiatry* 18:356–60. [AT]
- Popik, P. & van Ree, J. M. (1991) Oxytocin but not vasopressin facilitates social recognition following injection into the medial preoptic area of the rat abrain. *European Neuropsychopharmacology* 1:555–60. [aRAD]
- (1993) Social transmission of flavored tea preferences: Facilitation by a vasopressin analog and oxytocin. *Behavioral Neurology and Biology* 59:63–68. [aRAD]
- Popik, P., Vetulani, J. & van Ree, J. M. (1992) Low doses of oxytocin facilitate social recognition in rats. *Psychopharmacology* 106:71–74. [aRAD]
- Porges, S. (1998) Love: An emergent property of the mammalian autonomic nervous system. *Psychoneuroendocrinology* 23:837–61. [CSC, aRAD]
- (2001) The polyvagal theory: Phylogenetic substrates of a social nervous system. *International Journal of Psychophysiology* 42:123–46. [aRAD]
- (2003a) The polyvagal theory: Phylogenetic contributions to social behavior. *Physiology and Behavior* 79:503–13. [CSC]
- (2003b) Social engagement and attachment: A phylogenetic perspective. *Annals of the New York Academy of Sciences* 1008:31–47. [CSC]
- Porter, R. H. (1999) Olfaction and human kin recognition. *Genetics* 104:259–63. [aRAD]
- Porter, R. H., Makin, J. W., Davis, L. B. & Christensen, K. M. (1991) Breast-fed infants respond to olfactory cues from their own mother and unfamiliar lactating females. *Infant Behavioral Development* 16:169–74. [aRAD]
- Preston, S. & de Waal, F. B. M. (2001) Empathy: Its ultimate and proximate bases. *Behavioral and Brain Sciences* 24:233–56. [aRAD]
- Price, J. (1999) Prefrontal cortical networks related to visceral function and mood. In: *Advancing from the ventral striatum to the extended amygdala*, ed. J. F. McGinty. *Annals of the New York Academy of Sciences* 877:383–96. [aRAD]
- Price, J., Carmichael, S. & Drevets, W. (1996) Networks related to the orbital and medial prefrontal cortex, a substrate for emotional behavior? *Progress in Brain Research* 107:523–36. [aRAD]
- Puglisi-Allegra, S. & Cabib, S. (1997) Psychopharmacology of dopamine: The contribution of comparative studies in inbred strains of mice. *Progress in Neurobiology* 51:637–61. [aRAD]
- Rajkowska, G., Miguel-Hidalgo, J. J., Wei, J., Dille, G., Pittman, S. D., Meltzer, H. Y., Overholser, J. C., Roth, B. L. & Stockmeier, C. A., (1999) Morphometric evidence for neuronal and glial prefrontal cell pathology in major depression. *Biological Psychiatry* 45:1085–98. [DAP]
- Rakic, P., Bourgeois, J., Eckenhoff, M., Zecevic, M. & Goldman-Rakic, P. (1986) Concurrent overproduction of synapses in diverse regions of primate cerebral cortex. *Science* 286:232–34. [aRAD]
- Raleigh, M. J., Brammer, G. L., Yuwiler, A., Flannery, J. W., McGuire, M. T. & Geller, E. (1980) Serotonergic influences on the social behavior of vervet monkeys (*Cercopithecus aethiops sabaues*). *Experimental Neurology* 68:322–34. [SNY]
- Ramsey, N., Gerrits, M. & van Ree, J. (1999) Naltrexone affects cocaine self-administration in naive rats through the ventral tegmental area rather than dopaminergic target regions. *European Neuropsychopharmacology* 9:93–99. [aRAD]
- Ranote, S., Elliott, R., Abel, K. M., Mitchell, R., Deakin, J. F. & Appleby, L. (2004) The neural basis of maternal responsiveness to infants: An fMRI study. *Neuroreport* 15(11):1825–29. [JES]
- Raynor, K., Kong, H., Chen, Y., Tasuda, K., Yu, L., Bell, G. & Reisine, T. (1994) Pharmacological characterization of the cloned κ -, δ -, and μ -opioid receptors. *Molecular Pharmacology* 45:330–34. [aRAD]
- Redgrave, P., Prescott, T. J. & Gurney, K. (1999) Is the short-latency dopamine response too short to signal reward error? *Trends in Neurosciences* 22:146–51. [DJZ]
- Reisine, T. & Pasternak, G. (1996) Opioid analgesics and antagonists. In: *The pharmacological basis of therapeutics*, ed. J. Hardman & L. Limbird. McGraw Hill. [aRAD]
- Renelli, A., Bertolini, A., Poggioli, R., Menozzi, B., Basaglia, R. & Arletti, R. (1995) Polymodal dose-response curve for oxytocin in the social recognition test. *Neuropeptides* 28:251–55. [aRAD]
- Richard, P., Moos, F. & Freund-Mercier, M.-J. (1991) Central effects of oxytocin. *Physiological Reviews* 71(2):331–70. [aRAD]
- Robbins, T., Cadour, M., Taylor, J. & Everitt, B. (1989) Limbic-striatal interactions in reward-related processes. *Neuroscience and Biobehavioral Reviews* 13:155–62. [aRAD]
- Roberts, D. & Zito, K. (1987) Interpretation of lesion effects on stimulant self-administration. In: *Methods of assessing the reinforcing properties of abused drugs*, ed. M. Bozarth. Springer-Verlag. [aRAD]
- Roberts, R. L., Miller, A. K., Taymans, S. E. & Carter, C. S. (1998) Role of social and endocrine factors in alloparental behavior of prairie voles (*Microtus ochrogaster*). *Canadian Journal of Zoology* 76:1862–68. [CSC]
- Robinson, T. & Berridge, K. (1993) The neural basis of drug craving: An incentive sensitization theory of addiction. *Brain Research Reviews* 18:247–91. [aRAD]
- Robledo, P., Maldonado-Lopez, R. & Koob, G. (1992) Role of dopamine receptors in the nucleus accumbens in the rewarding properties of cocaine. In: *The neurobiology of drug and alcohol addiction*, ed. P. Kalivas & H. Samson. *Annals of the New York Academy of Sciences* 654:509–28. [aRAD]
- Rogers, R., Owen, A., Middleton, H., Williams, E., Pickard, J., Sahakian, B. & Robbins, T. (1999) Choosing between small, likely rewards and large, unlikely rewards activates inferior and orbital prefrontal cortex. *Journal of Neuroscience* 19:9029–38. [aRAD]
- Rolls, E. T. (1999) *The brain and emotion*. Oxford University Press. [aRAD]

- (2000) The orbitofrontal cortex and reward. *Cerebral Cortex* 10:284–94. [aRAD]
- Rolls, E. T., Kringelbach, M. L. & de Araujo, I. E. (2003) Different representations of pleasant and unpleasant odours in the human brain. *European Journal of Neuroscience* 18:695–703. [PO]
- Romach, M., Glue, P., Kampman, K., Kaplan, H., Somer, G., Poole, S., Clark, L., Coffin, V., Cornish, J., O'Brien, C. & Sellers, E. (1999) Attenuation of the euphoric effects of cocaine by the dopamine D1/D5 antagonist ecopipam (SCH39166). *Archives of General Psychiatry* 56:1101–06. [aRAD]
- Rosenblatt, J. S. (1994) Psychobiology of maternal behavior: Contribution to the clinical understanding of maternal behavior among humans. *Acta Paediatrica* (Supplement) 397:3–8. [aRAD]
- Rosenblum, L. A., Smith, E. L. P., Altemus, M., Scharf, B. A., Owens, M. J., Nemeroff, C. B., Gorman, J. M. & Coplan, J. D. (2002) Differing concentrations of corticotropin-releasing factor and oxytocin in the cerebrospinal fluid of bonnet and pigtail macaques. *Psychoneuroendocrinology* 27(6):651–60. [TARW]
- Rothbart, M. K., Derryberry, D. & Posner, M. I. (1994) A psychobiological approach to the development of temperament. In: *Temperament: Individual differences at the interface of biology and behavior*, ed. J. E. Bates & T. D. Wachs, pp. 83–116. American Psychological Association. [WBMM]
- Rowe, D. A., Bullock, P. R., Polkey, C. E. & Morris, R. G. (2001) Theory of mind impairments and their relationship to executive functioning following frontal lobe lesions. *Brain* 124:600–16. [R-PB]
- Rueter, L. E., Fornal, C. A. & Jacobs, B. L. (1997) A critical review of 5-HT brain microdialysis and behavior. *Reviews in the Neurosciences* 8:117–37. [SNY]
- Russell, J. A. & Leng, G. (1998) Sex, parturition and motherhood without oxytocin? *Journal of Endocrinology* 157:343–59. [aRAD]
- Ruys, J. D., Capitano, J. P., Gietzen, D. W., Mendoza, S. P., Wolf, D. & Smith, D. G. (in preparation) Central neurochemical correlates of personality in nonhuman primates. [TARW]
- Sanfey, A. G., Rilling, J. K., Aronson, J. A., Nystrom, L. E. & Cohen, J. D. (2003) The neural basis of economic decision-making in the ultimatum game. *Science* 300:1755–58. [DJZ]
- Sarnyai, Z. & Kovacs, G. (1993) Role of oxytocin in the neuroadaptation to drugs of abuse. *Psychoneuroendocrinology* 19:85–117. [aRAD]
- Sarnyai, Z., Szabo, G., Kovacs, G. & Telegdy, G. (1990) Oxytocin attenuates the cocaine-induced exploratory hyperactivity in mice. *NeuroReport* 1:200–02. [aRAD]
- Sathe, R., Komisaruk, B., Ladas, A. & Godbole, S. (2001) Naltrexone-induced augmentation of sexual response in men. *Archives of Medical Research* 32:221–26. [aRAD]
- Saxton, P. M., Siegel, J. & Lukas, J. H. (1987) Visual evoked potential augmenting/reducing slopes in cats 2. Correlations with behavior. *Personality and Individual Differences* 8:511–19. [MZ]
- Scalaidhe, S., Wilson, F. & Goldman-Rakic, P. (1997) Areal segregation of face-processing neurons in prefrontal cortex. *Science* 278:1135–38. [aRAD]
- Schacter, D. (1996) *In search of memory*. Basic Books. [aRAD]
- Schino, G. & Troisi, A. (1992) Opiate receptor blockade in juvenile macaques: Effect on affiliative interactions with their mothers and group companions. *Brain Research* 576:125–30. [AT]
- Schlaepfer, T. E., Strain, E. C., Greenberg, B. D., Preston, K. L., Lancaster, E., Bigelow, G. E., Barta, P. E. & Pearson, G. D. (1998) Site of opioid action in the human brain: Mu and kappa agonists' subjective and cerebral blood flow effects. *American Journal of Psychiatry* 155(4):470–73. [aRAD]
- Schinka, J. A., Musch, R. M. & Robichaux-Keene, N. (2004) A meta-analysis of the association between the serotonin transporter gene polymorphism (5-HTTLPR) and trait anxiety. *Molecular Psychiatry* 9:197–202. [MRM]
- Schino, G. & Troisi, A. (1992) Opiate receptor blockade in juvenile macaques: Effect on affiliative interactions with their mothers and group companions. *Brain Research* 576:125–30. [AT, TARW]
- Schneirla, T. (1959) An evolutionary and developmental theory of biphasic processes underlying approach and withdrawal. In: *Nebraska Symposium on Motivation*, ed. M. Jones. University of Nebraska Press. [aRAD]
- Schneider, A. (2003) Spontaneous confabulation and the adaptation of thought to ongoing reality. *Nature Reviews Neuroscience* 4:662–71. [aRAD]
- Schneider, A., Treyer, V. & Buck, A. (2000) Selection of currently relevant memories by the human posterior medial orbitofrontal cortex. *Journal of Neuroscience* 20:5880–84. [aRAD]
- Schoenbaum, G., Chiba, A. A. & Gallagher, M. (1998) Orbitofrontal cortex and basolateral amygdala encode expected outcomes during learning. *Nature Neuroscience* 1(3):155–59. [aRAD]
- Schore, A. (1996) The experience-dependent maturation of a regulatory system in the orbital prefrontal cortex and the origin of developmental psychopathology. *Developmental Psychopathology* 8:59–87. [aRAD]
- (1997) Early organization of the nonlinear right brain and development of a predisposition to psychiatric disorders. *Developmental Psychopathology* 9:595–631. [aRAD]
- Schultz, R. & Klin, A. (2002) Genetics of childhood disorders: XLIII. Autism, Part 2: Neural foundations. *Journal of the American Academy of Child and Adolescent Psychiatry* 41:1259–62. [R-PB]
- Schultz, W. (1986) Responses of midbrain dopamine neurons to trigger stimuli in the monkey. *Journal of Neurophysiology* 56:1439–61. [aRAD]
- Schultz, W., Apicella, P. & Ljungberg, T. (1993) Responses of monkey dopamine neurons to reward and conditioned stimuli during successive steps of learning a delayed response task. *Journal of Neuroscience* 13:900–18. [aRAD]
- Schultz, W., Apicella, P., Romo, R. & Scarnati, E. (1995a) Context-dependent activity in primate striatum reflecting past and future behavioral events. In: *Models of information processing in the basal ganglia*, ed. J. Houk, J. J. Davis & D. Beiser. MIT Press. [aRAD]
- Schultz, W., Apicella, P., Scarnati, E. & Ljungberg, T. (1992) Neuronal activity in monkey ventral striatum related to the expectation of reward. *Journal of Neuroscience* 12:4595–99. [aRAD]
- Schultz, W., Dayan, P. & Montague, P. (1997) A neural substrate of prediction and reward. *Science* 275:1593–95. [aRAD, DJZ]
- Schultz, W., Romo, R., Ljungberg, T., Mirenovic, J., Hollerman, J. & Dickinson, A. (1995b) Reward-related signals carried by dopamine neurons. In: *Models of information processing in the basal ganglia*, ed. J. Houk, J. J. Davis & D. Beiser. MIT Press. [aRAD]
- Schwartz, D., McClane, S., Hernandez, L. & Hoebel, B. (1989) Feeding increases extracellular serotonin in the lateral hypothalamus of the rat as measured by microdialysis. *Brain Research* 479:349–54. [aRAD]
- Sesack, S. R. & Pickel, V. M. (1990) In the rat medial nucleus accumbens, hippocampal and catecholaminergic terminals converge on spiny neurons and are in apposition to each other. *Brain Research* 527(2):266–79. [aRAD]
- (1992) Prefrontal cortical efferents in the rat synapse on unlabeled neuronal targets of catecholamine terminals in the nucleus accumbens septi and on dopamine neurons in the ventral tegmental area. *Journal of Comparative Neurology* 320(2):145–60. [aRAD]
- Sesack, S. R., Aoki, C. & Pickel, V. M. (1994) Ultrastructural localization of D2 receptor-like immunoreactivity in midbrain dopamine neurons and their striatal targets. *Journal of Neuroscience* 14:88–106. [aRAD]
- Seifritz, E., Esposito, F., Neuhoft, J. G., Luthi, A., Mustovic, H., Dammann, G., von Bardeleben, U., Radue, E. W., Cirillo, S., Tedeschi, G. & Di Salle, F. (2003) Differential sex-independent amygdala response to infant crying and laughing in parents versus nonparents. *Biological Psychiatry* 54(12):1367–75. [JES]
- Selden, N., Everitt, B., Jarrard, L. & Robbins, T. (1991) Complementary roles of the amygdala and hippocampus in aversive conditioning to explicit and contextual cues. *Neuroscience* 42:335–50. [aRAD]
- Sell, L., Morris, J., Bearn, R., Frackowiak, R., Frison, K. & Dolan, R. (1999) Activation of reward circuitry in human opiate addicts. *European Journal of Neuroscience* 11:1042–48.
- Sen, S., Burmeister, M. & Ghosh, D. (2004) Meta-analysis of the association between a serotonin transporter promoter polymorphism (5-HTTLPR) and anxiety-related personality traits. *American Journal of Medical Genetics* 127B:85–89. [MRM]
- Shah, P. J., Ogilvie, A. D., Goodwin, G. M. & Ebmeier, K. P. (1997) Clinical and psychometric correlates of dopamine D2 binding in depression. *Psychological Medicine* 27:1247–52. [DAP]
- Shaham, Y., Erb, S. & Stewart, J. (2000) Stress-induced relapse to heroin and cocaine seeking in rats: A review. *Brain Research Reviews* 33(1):13–33. [aRAD]
- Shapiro, L. & Insel, T. R. (1989) Ontogeny of oxytocin receptors in rat forebrain: A quantitative study. *Synapse* 4:259–66. [aRAD]
- Sharp, F., Liu, J., Nickolenko, J. & Bontempi, B. (1995) NMDA and D1 receptors mediate induction of c-fos and junE genes in striatum following morphine administration: Implications for studies of memory. *Behavioural Brain Research* 66:225–30. [aRAD]
- Sheffield, F., Wulff, A. & Backer, R. (1955) Reward value of copulation without sex drive reduction. *Journal of Comparative Physiological Psychology* 44:3–8. [aRAD]
- Sher, L. (1997) Autistic disorder and the endogenous opioid system. *Medical Hypotheses* 48:413–14. [RAD, AT]
- Shi, S., Hayashi, Y., Petralia, R., Zaman, S., Wenthold, R., Svoboda, K. & Malinow, R. (1999) Rapid spine delivery and redistribution of AMPA receptors after synaptic NMDA receptor activation. *Science* 284:1811–16. [aRAD]
- Shippenberg, T. & Herz, A. (1988) Motivational effects of opioids: Influence of D1 vs D2 receptor antagonists. *European Journal of Pharmacology* 151:233–43. [aRAD]
- Shippenberg, T. S. & Elmer, G. I. (1998) The neurobiology of opiate reinforcement. *Critical Reviews in Neurobiology* 12(4):267–303. [aRAD]
- Siegel, J., Sisson, D. F. & Driscoll, P. (1993) Augmenting and reducing of visual evoked potentials in Roman high- and low-avoidance rats. *Physiology and Behavior* 54:707–11. [MZ]

- Silk, J. B., Alberts, S. C. & Altmann, J. (2003) Social bonds of female baboons enhance infant survival. *Science* 302:1231–34. [aRAD]
- Simon, E. & Gioannini, T. (1993) Opioid receptor multiplicity. In: *Handbook of experimental pharmacology*, ed. A. Herz. Springer-Verlag. [aRAD]
- Simonin, F., Valverde, O., Smadja, C., Slove, S., Kitchen, I., Dietrich, A., Le Meur, M., Roques, B., Maldonado, R. & Kieffer, B. (1998) Disruption of the kappa-opioid receptor gene in mice enhances sensitivity to chemical visceral pain, impairs pharmacological actions of the selective kappa-agonist U-50,488H and attenuates morphine withdrawal. *European Journal of Molecular Biology* 17:886–97. [aRAD]
- Sinchak, K. & Micevych, P. (2001) Progesterone blockade of estrogen activation of μ -opioid receptors regulates reproductive behavior. *Journal of Neuroscience* 21:5723–29. [aRAD]
- Skeem, J. L., Poythress, N., Edens, J. F., Lilienfeld, S. O. & Cale, E. M. (2003) Psychopathic personality or personalities? Exploring potential variants of psychopathy and their implications for risk assessment. *Aggression and Violent Behavior* 8:513–46. [AT]
- Slamberova, R., Szilagyi, B. & Vathy, I. (2001) Repeated morphine administration during pregnancy attenuates maternal behavior. *Psychoneuroendocrinology* 26:565–76. [JES]
- Sloan, D. M., Strauss, M. E. & Wisner, K. L. (2001) Diminished response to pleasant stimuli by depressed women. *Journal of Abnormal Psychology* 110:488–93. [DAP]
- Smith, J., Guerin, G., Co, C., Barr, T. & Lane, J. (1985) Effects of 6-OHDA lesions of the central medial nucleus accumbens on rat intravenous morphine self-administration. *Pharmacology, Biochemistry and Behavior* 23:234–49. [aRAD]
- Smith, V. (1998) The two faces of Adam Smith. *Southern Economic Journal*. 65(1):1–29. [PJZ]
- Smolka, M., Sander, T., Schmidt, L. G., Samochowiec, J., Rommelspacher, H., Gescheidel, N., Wendel, B. & Hoehe, M. R. (1999) μ -Opioid receptor variants and dopaminergic sensitivity in alcohol withdrawal. *Psychoneuroendocrinology* 24:629–38. [aRAD]
- Sober, E. & Wilson, D. S. (1998) *Unto others: The evolution and psychology of unselfish behavior*. Harvard University Press. [SLB, MG]
- Sora, I., Takahashi, N., Funada, M., Ujike, H., Revay, R. S., Donovan, D. M., Miner, L. L. & Uhl, G. R. (1997) Opiate receptor knockout mice define μ receptor roles in endogenous nociceptive responses and morphine-induced analgesia. *Proceedings of the National Academy of Sciences* 94:1544–49. [aRAD]
- Spanagel, R., Herz, A., Bals-Kubik, R. & Shippenberg, T. (1991) β -Endorphin-induced locomotor stimulation and reinforcement are associated with an increase in dopamine release in the nucleus accumbens. *Psychopharmacology* 104:51–56. [aRAD]
- Sparks, B. F., Friedman, S. D., Shaw, D. W., Aylward, E. H., Echelard, D., Artru, A. A., Maravilla, K. R., Giedd, J. N., Munson, J., Dawson, G. & Dager, S. R. (2002) Brain structural abnormalities in young children with autism spectrum disorder. *Neurology* 59:184–92. [R-PB]
- Spoont, M. (1992) Modulatory role of serotonin in neural information processing: Implications for human psychopathology. *Psychological Bulletin* 112:330–50. [aRAD]
- Spoont, M. R. (1992) Modulatory role of serotonin in neural information processing: Implications for human psychopathology. *Psychological Bulletin* 112:330–50. [SNY]
- Stafisso-Sandoz, G., Polley, D., Holt, E., Lambert, K. G. & Kinsley, C. H. (1998) Opiate disruption of maternal behavior: Morphine reduces, and naloxone restores, c-fos activity in the medial preoptic area of lactating rats. *Brain Research Bulletin* 45:307–13. [JES]
- Steckler, T. & Sahgal, A. (1995) The role of serotonergic–cholinergic interactions in the mediation of cognitive behaviour. *Behavioural Brain Research* 67:165–99. [DJZ]
- Stefano, G. & Scharrer, B. (1994) Endogenous morphine and related opiates, a new class of chemical messengers. *Advances in Neuroimmunology* 4:57–68. [aRAD]
- Stefano, G., Goumon, Y., Casares, F., Cadet, P., Fricchione, G., Rialas, C., Peter, D., Sonetti, D., Guarna, M., Welters, I. & Bianchi, E. (2000) Endogenous morphine. *Trends in Neurosciences* 23:436–42. [aRAD]
- Stefano, G., Owen, B. & Brody, A. (1996) Opioid and opiate immunoregulatory processes. *Critical Reviews in Immunology* 16:109–44. [aRAD]
- Steklis, H. & Kling, A. (1985) Neurobiology of affiliative behavior in nonhuman primates. In: *The psychobiology of attachment and separation*, ed. M. Reite & T. Field. Academic. [aRAD]
- Stern, J. (1990) Multisensory regulation of maternal behavior and masculine sexual behavior. *Neuroscience and Biobehavioral Reviews* 14:183–200. [aRAD]
- Stevenson-Hinde, J. & Zunz, M. (1978) Subjective assessment of individual rhesus monkeys. *Primates* 19(3):473–82. [TARW]
- Stewart, J., de Wit, H. & Eikelboom, R. (1984) Role of unconditioned and conditioned drug effects in the self-administration of opiates and stimulants. *Psychological Review* 91:51–268. [aRAD]
- Strand, F. L. (1999) *Neuropeptides: Regulators of physiological processes*. MIT Press. [aRAD]
- Stribley, J. M. & Carter, C. S. (1999) Developmental exposure to vasopressin increases aggression in adult prairie voles. *Proceedings of the National Academy of Sciences* 96:12601–04. [CSC]
- Stricker, E. & Zigmond, M. (1986) Brain monoamines, homeostasis and adaptive behavior. In: *Handbook of physiology: Section 1. The nervous system, vol. IV. Intrinsic regulatory systems of the brain*, pp. 677–700. American Physiological Society. [aRAD]
- Strogatz, S. H. (1994) *Nonlinear dynamics and chaos*. Perseus. [KI]
- Snaud-Chagny, M., Dhergui, K., Chouvet, G. & Gonon, F. (1992) Relationship between dopamine release in the rat nucleus accumbens and the discharge activity of dopaminergic neurons during local in vivo application of amino acid in the ventral tegmental area. *Neuroscience* 49:63–78. [aRAD]
- Sullivan, R. & Gratton, A. (2002) Prefrontal cortical regulation of hypothalamic-pituitary-adrenal function in the rat and implications for psychopathology: Side matters. *Psychoneuroendocrinology* 27:99–114. [aRAD]
- Suslow, T., Jungmann, K. & Arolt, K. (2001) Detection of facial expressions in depression. *Perceptual & Motor Skills* 92:857–68. [DAP]
- Sutherland, R. & McDonald, R. (1990) Hippocampus, amygdala and memory deficits in rats. *Behavioral and Brain Research* 37:57–79. [aRAD]
- Suzuki, T., Mori, T., Tsuji, M., Misawa, M. & Nagase, H. (1994) The role of δ -opioid receptor subtypes in cocaine- and methamphetamine-induced place preferences. *Life Science* 55:PL339–PL344. [aRAD]
- Svingos, A., Moriwaki, A., Wang, J., Uhl, G. & Pickel V (1996) Ultrastructural immunocytochemical localization of μ -opioid receptors in rat nucleus accumbens: Extrasynaptic plasmalemmal distribution and association with leu5-enkephalin. *Journal of Neuroscience* 16:4162–73. [aRAD]
- Swain, J. E., Leckman, J. F., Mayes, L. C., Feldman, R., Constable, R. T. & Schultz, R. T. (2004) The neural substrate of human parent–infant attachment in the postpartum. *Biological Psychiatry* 55(8):153S. [JES]
- Swain, J. E., Mayes, L. C. & Leckman, J. F. (in press) The development of parent–infant attachment through dynamic and interactive signalling loops of care and cry. *Behavioral and Brain Sciences*. [JES]
- Taber, M., Das, S. & Fibiger, H. (1995) Cortical regulation of subcortical dopamine release: Mediation via the ventral tegmental area. *Journal of Neurochemistry* 65:1407–10. [aRAD]
- Tager-Flusberg, H., Joseph, R. & Folstein, S. (2001) Current directions in research on autism. *Mental Retardation and Developmental Disabilities Research Reviews* 7:21–29. [R-PB]
- Takagishi, M. & Chiba, T. (1991) Efferent projections of the infralimbic (area 25) region of the medial prefrontal cortex in the rat. *Brain Research* 566:26–39. [aRAD]
- Taris, T. & Semin, G. (1997) Passing on the faith: How mother–child communication influences transmission of moral values. *Journal of Moral Education* 26(2):211–21. [NNP]
- Taylor, E., Klein, L., Lewis, B., Gruenewald, T., Regan, A., Gurung, R. & Updegraff, J. (2000) Biobehavioral responses to stress in females: Tend-and-befriend, not fight-or-flight. *Psychological Bulletin* 107:411–29. [aRAD]
- Taylor, S. E., Klein, L. C., Lewis, B. P., Gruenewald, T. L., Gurung, R. A. R. & Updegraff, J. A. (2000) Biobehavioral responses to stress in females: Tend-and-befriend, not fight-or-flight. *Psychological Review* 107:411–29. [DSL]
- Tellegen, A. (1982) *Multidimensional Personality Questionnaire Manual*. University of Minnesota Press. [PN]
- Tellegen, A., Lykken, D. T., Bouchard, T. J., Wilcox, K. J., Segal, N. L. & Rich, S. (1988) Personality similarity in twins reared apart and together. *Journal of Personality and Social Psychology* 54:1031–39. [aRAD]
- Tellegen, A. & Waller, N. G. (in press) Exploring personality through test construction: Development of the multidimensional personality questionnaire. In: *Personality measures: Development and evaluation, vol. 1*, ed. S. Briggs & J. Cheek. JAI Press. [aRAD]
- Thompson, A. C. & Kristal, M. B. (1996) Opioid stimulation in the ventral tegmental area facilitates the onset of maternal behavior in rats. *Brain Research* 743:184–201. [SLB]
- Thorpe, S., Rolls, E. & Maddison, S. (1983) The orbitofrontal cortex: Neuronal activity in the behaving monkey. *Experimental Brain Research* 49:93–113. [aRAD]
- Timberlake, W. (1994) Behavior systems, associationism, and Pavlovian conditioning. *Psychonomic Bulletin and Review* 1(4):405–20. [aRAD]
- Timberlake, W. & Silva, K. (1995) Appetitive behavior in ethology, psychology, and behavior systems. In: *Perspectives in ethology, vol 11. Behavioral design*, ed. N. Thompson. Plenum. [aRAD]
- Toates, F. (1986) *Motivational systems*. Cambridge University Press. [aRAD]
- Tomizawa, K., Iga, N., Lu, Y.-F., Moriwaki, A., Matsushita, M., Li, S.-T., Miyamoto, O., Itano, T. & Matsui, H. (2003) Oxytocin improves long-lasting spatial memory during motherhood through MAP kinase cascade. *Nature Neuroscience* 6:384–90. [aRAD]
- Toshihiko, A., Graybiel, A. & Kimura, M. (1994) Effect of the nigrostriatal

- dopamine system on acquired neural responses in the striatum of behaving monkeys. *Science* 265:412–15. [aRAD]
- Townsend, J., Courchesne, E., Singer-Harris, N., Covington, J., Westerfield, M., Lyden, P., Lowry, T. P. & Press, G. A. (1999) Spatial attention deficits in patients with acquired or developmental cerebellar abnormality. *Journal of Neuroscience* 19:5632–43. [R-PB]
- Tremblay, L. & Schultz, W. (1999) Relative reward preference in primate orbitofrontal cortex. *Nature* 398:704–08. [aRAD]
- Tremblay, L. K., Naranjo, C. A., Cardenas, L., Herrmann, N. & Busto, U. E. (2002) Probing brain reward system function in major depressive disorder: Altered response to dextroamphetamine. *Archives of General Psychiatry* 59:409–16. [DAP]
- Trujillo, K., Belluzzi, J. & Stein, L. (1991) Naloxone blockade of amphetamine place preference conditioning. *Psychopharmacology* 104:265–74. [aRAD]
- Tse, W. S. & Bond, A. J. (2002) Serotonergic intervention affects both social dominance and affiliative behavior. *Psychopharmacology* 161:324–30. [SNY]
- Tseng, K. Y. & O'Donnell, P. (2004) Dopamine–glutamate interactions controlling prefrontal cortical pyramidal cell excitability involve multiple signaling mechanisms. *Journal of Neuroscience* 24:5131–39. [PO]
- Uhl, G. R., Sora, I. & Wang, Z. (1999) The μ opiate receptor as a candidate gene for pain: Polymorphisms, variations in expression, nociception, and opiate responses. *Proceedings of the National Academy of Sciences USA* 96:7752–55. [aRAD]
- Uvnas-Moberg, K. (1997) Physiological and endocrine effects of social contact. In: *The integrative neurobiology of affiliation*, ed. C. S. Carter, I. I. Lederhendler & B. Kirkpatrick. *Annals of the New York Academy of Sciences* 807:146–63. [aRAD]
- Uvnas-Moberg, K. (1998) Oxytocin may mediate the benefits of positive social interaction and emotions. *Psychoneuroendocrinology* 23(8):819–35. [aRAD, DSL]
- Uvnas-Moberg, K., Alster, P., Hillegaart, V. & Ahlenius, S. (1995) Suggestive evidence for a DA D3 receptor-mediated increase in the release of oxytocin in the male rat. *NeuroReport* 6:1338–40. [aRAD]
- Uvnas-Moberg, K., Widstrom, A.-M., Nissen, E. & Bjorvell, H. (1990) Personality traits in women 4 days postpartum and their correlation with plasma levels of oxytocin and prolactin. *Journal of Psychosomatic Obstetrics and Gynaecology* 11:261–73. [aRAD]
- Valenza, E., Simion, F., Cassia, V. M. & Umiltà, C. (1996) Face preference at birth. *Journal of Experimental Psychology. Human Perception and Performance* 22:892–903. [R-PB]
- Vallacher, R. R., Read, S. J. & Nowak, A. (2002) The dynamical perspective in personality and social psychology. *Personality and Social Psychology Review* 6:264–73. [KI]
- van der Geest, J. N., Kemner, C., Camfferman, G., Verbaten, M. N. & van Engeland, H. (2001) Eye movements, visual attention, and autism: A saccadic reaction time study using the gap and overlap paradigm. *Biological Psychiatry* 50:614–19. [R-PB]
- van der Kooy, D., Mucha, R., O'Shughnessy, M. & Buceniels, P. (1982) Reinforcing effects of brain microinjections of morphine revealed by conditioned place preference. *Brain Research* 243:107–17. [aRAD]
- van Vliet, I. M., den Boer, J. A. & Westenberg, H. G. M. (1994) Psychopharmacological treatment of social phobia: A double blind placebo controlled study with fluvoxamine. *Psychopharmacology* 115:128–34. [SNY]
- Vanderschuren, L., Stein, E., Wiegant, V. & van Ree, J. (1995) Social isolation and social interaction alter regional brain opioid receptor binding in rats. *European Neuropsychopharmacology* 5:119–27. [aRAD]
- van Furth, W. & van Ree, J. (1996) Sexual motivation: Involvement of endogenous opioids in the ventral tegmental area. *Brain Research* 729:20–28. [aRAD]
- van Furth, W., Wolterink-Donselaar, I. & van Ree, J. (1994) Endogenous opioids are differentially involved in appetitive and consummatory aspects of sexual behavior of male rats. *American Journal of Physiology* 266:R606–R613. [aRAD]
- van Ree, J. & De Wied, D. (1977) Modulation of heroin self-administration by neurohypophyseal principles. *European Journal of Pharmacology* 43:199–202. [aRAD]
- Vathy, I. (2002) Prenatal opiate exposure: Long-term CNS consequences in the stress system of the offspring. *Psychoneuroendocrinology* 27:273–83. [JES]
- Vathy, I. & Etgen, A. (1989) Hormonal activation of female sexual behavior is accompanied by hypothalamic norepinephrine release. *Journal of Neuroendocrinology* 1:383–88. [aRAD]
- Veit, R., Flor, H., Erb, M., Hermann, C., Lotze, M., Grood, W. & Birbaumer, N. (2002) Brain circuits involved in emotional learning in antisocial behavior and social phobia in humans. *Neuroscience Letters* 328:233–36. [AT]
- Volkow, N., Wang, G., Fischman, M., Foltin, R., Fowler, J., Abumrad, N., Vitkun, S., Logan, J., Gatley, S., Pappas, N., Hitzemann, R. & Shea, C. (1997) Relationship between subjective effects of cocaine and dopamine transporter occupancy. *Nature* 386:827–29. [aRAD]
- Voorn, P., Brady, L. S., Berendse, H. W. & Richfield, E. K. (1996) Densitometrical analysis of opioid receptor ligand binding in the human striatum. I: Distribution of opioid receptors defines shell and core of the ventral striatum. *Neuroscience* 75:777–92. [aRAD]
- Wang, H., Gracy, K. N. & Pickel, V. M. (1999) μ -Opioid and NMDA-type glutamate receptors are often colocalized in spiny neurons within patches of the caudate-putamen nucleus. *Journal of Comparative Neurology* 412:132–46. [aRAD]
- Wang, Z. & Devries, G. (1993) Testosterone effects on paternal behavior and vasopressin immunoreactive projections in prairie voles. *Brain Research* 631:156–60. [aRAD]
- Wang, Z., Smith, W., Major, D. & de Vries, G. (1994) Sex and species differences in the effects of cohabitation on vasopressin messenger RNA expression in the bed nucleus of the stria terminalis in prairie voles (*Microtus ochrogaster*) and meadow voles (*Microtus pennsylvanicus*). *Brain Research* 650:212–18. [aRAD]
- Wang, Z., Yu, G., Cascio, C., Liu, Y., Gingrich, B. & Insel, T. R. (1999) Dopamine D2 receptor-mediated regulation of partner preferences in female prairie voles (*Microtus ochrogaster*): A mechanism for pair bonding? *Behavioral Neuroscience* 113(3):602–11. [aRAD]
- Watanabe, M. (1990) Prefrontal unit activity during associative learning in the monkey. *Brain Research* 50:296–311. [aRAD]
- Waterhouse, L., Fein, D. & Modahl, C. (1996) Neurofunctional mechanisms in autism. *Psychological Review* 103(3):457–89. [aRAD]
- Watson, C. & Clark, L. (1997) Extraversion and its positive emotional core. In: *Handbook of personality psychology*, ed. S. Briggs, W. Jones & R. Hogan. Academic. [aRAD]
- Watson, D., Clark, L. A. & Tellegen, A. (1988) Development and validation of brief measures of positive and negative affect: The PANAS scales. *Journal of Personality and Social Psychology* 54:1063–70. [DJZ]
- Watson, D. & Tellegen, A. (1985) Towards a consensual structure of mood. *Psychological Bulletin* 98:219–35. [aRAD]
- Weaver, I. C., Cervoni, N., Champagne, F. A., D'Alessio, A. C., Sharma, S., Seckl, J. R., Dymov, S., Szyf, M. & Meaney, M. J. (2004) Epigenetic programming by maternal behavior. *Nature Neuroscience* 7(8):847–54. [CSC, rRAD]
- Wedekind, C., Seebeck, T., Bettens, F. & Paepke, A. J. (1995) MHC-dependent mate preferences in humans. *Proceedings of the Royal Society of London, B* 287:245–49. [aRAD]
- Weiss, F., Hurd, Y., Ungerstedt, U., Markou, A., Plotsky, P. & Koob, G. (1992) Neurochemical correlates of cocaine and ethanol self-administration. *Annals of the New York Academy of Sciences* 654:435–55. [aRAD]
- Wellmann, J., Carr, D., Graham, A., Jones, H., Humm, J. L., Ruscio, M., Billack, B. & Kinsley, C. H. (1997) Preoptic area infusions of morphine disrupt—and naloxone restores—parental-like behavior in juvenile rats. *Brain Research Bulletin* 44(2):183–91. [SLB, aRAD, JES]
- Wendel, B. & Hoehle, M. R. (1998) The human μ opioid receptor gene: 5' regulatory and intronic sequences. *Journal of Molecular Medicine* 76:525–32. [aRAD]
- Wenkstern, D., Pfau, J. & Fibiger, H. (1993) Dopamine transmission increase in the nucleus accumbens of male rats during their first exposure to sexually receptive female rats. *Brain Research* 618:41–46. [aRAD]
- White, N. (1986) Control of sensorimotor function by dopaminergic nigrostriatal neurons: Influence on eating and drinking. *Neuroscience and Biobehavioral Reviews* 10:15–36. [aRAD]
- White, N. M. (1997) Mnemonic functions of the basal ganglia. *Current Opinion in Neurobiology* 7(2):164–69. [aRAD]
- White, T. L. & Depue, R. A. (1999) Differential association of traits of fear and anxiety with norepinephrine- and dark-induced pupil reactivity. *Journal of Personality and Social Psychology* 77(4):863–77. [aRAD]
- Wickens, J. & Kotter, R. (1995) Cellular models of reinforcement. In: *Models of information processing in the basal ganglia*, ed. J. Houk, J. Davis & D. Beiser. MIT Press. [aRAD]
- Wickens, J. R., Begg, A. J. & Arbuthnot, G. W. (1996) Dopamine reverses the depression of rat corticostriatal synapses which normally follows high-frequency stimulation of cortex in vitro. *Neuroscience* 70(1):1–5. [aRAD]
- Wiedenmayer, C. & Barr, G. (2000) Mu opioid receptors in the ventrolateral periaqueductal gray mediate stress-induced analgesia but not immobility rat pups. *Behavioral Neuroscience* 114:125–38. [aRAD]
- Wiggins, J. (1991) Agency and communion as conceptual coordinates for the understanding and measurement of interpersonal behavior. In: *Thinking clearly about psychology: Essays in honor of Paul Everett Meehl*, ed. D. Cicchetti & W. Grove. University of Minnesota Press. [aRAD]
- Wiggins, J., Trapnell, P. & Phillips, N. (1988) Psychometric and geometric characteristics of the revised Interpersonal Adjective Scales (IAS-R). *Multivariate Behavioral Research* 23:517–30. [aRAD]
- Williams, J. R., Catania, K. & Carter, C. S. (1992) Development of partner preferences in female prairie voles: The role of social and sexual experience. *Hormones and Behavior* 26:339–49. [aRAD]
- Williams, J. R., Insel, T. R., Harbaugh, C. R. & Carter, C. S. (1994) Oxytocin

- administered centrally facilitates formation of a partner preference in female prairie voles (*Microtus ochrogaster*). *Journal of Neuroendocrinology* 6:247–50. [aRAD]
- Willis, W. & Westlund, K. (1997) Neuroanatomy of the pain system and of the pathways that modulate pain. *Journal of Clinical Neurophysiology* 14:2–31. [aRAD]
- Wilson, A., Soignier, R., Zadina, J., Kastin, A., Nores, W., Olson, R. & Olson, G. (2000) Dissociation of analgesic and rewarding effects of endomorphin-1 in rats. *Peptides* 21:1871–74. [aRAD]
- Wilson, C. & Kawaguchi, Y. (1996) The origins of two-state spontaneous membrane potential fluctuations of neostriatal spiny neurons. *Journal of Neuroscience* 16:2397–2410. [aRAD]
- Winocur, G. (1997) Hippocampal lesions alter conditioning to conditional and contextual stimuli. *Behavioural Brain Research* 88:219–29. [aRAD]
- Windle, R. J., Kershaw, Y. M., Shanks, N., Wood, S. A., Lightman, S. L. & Ingram, C. D. (2004) Oxytocin attenuates stress-induced c-fos mRNA expression in specific forebrain regions associated with modulation of hypothalamo-pituitary-adrenal activity. *Journal of Neuroscience* 24:2974–82. [DSL]
- Winslow, J. T. & Insel, T. R. (1991a) Endogenous opioids: Do they modulate the rat pup's response to social isolation? *Behavioral Neuroscience* 105(2):253–63. [aRAD, JP]
- (1991b) Social status in pairs of male squirrel monkeys determines the behavioral response to central oxytocin administration. *Journal of Neuroscience* 11(7):2032–38. [TARV]
- (2002) The social deficits of the oxytocin knockout mouse. *Neuropeptides* 36:221–29. [aRAD]
- (2004) Neuroendocrine basis of social recognition. *Current Opinion in Neurobiology* 14:248–53. [CSC]
- Winslow, J. T., Hastings, N., Carter, C. S., Harbaugh, C. R. & Insel, T. R. (1993) A role for vasopressin pair bonding in monogamous prairie voles. *Nature* 365:545–48. [CSC]
- Winslow, J. T., Noble, P. L., Lyons, C. K., Sterk, S. M. & Insel, T. R. (2003) Rearing effects on cerebrospinal fluid oxytocin concentration and social buffering in rhesus monkeys. *Neuropsychopharmacology* 28(5):910–18. [TARV]
- Winslow, J. T., Shapiro, L., Carter, C. S. & Insel, T. R. (1993) Oxytocin and complex social behaviour: Species comparisons. *Psychopharmacology Bulletin* 29(3):409–14. [aRAD]
- Winston, J. S., Strange, B. A., O'Doherty, J. & Dolan, R. J. (2002) Automatic and intentional brain responses during evaluation of trustworthiness of faces. *Nature Neuroscience* 5:277–83. [RAD]
- Wise, R. (1996) Addictive drugs and brain stimulation reward. *Annual Review of Neuroscience* 19:319–40. [aRAD]
- (1998) Drug-activation of brain reward pathways. *Drug and Alcohol Dependence* 51:13–22. [aRAD]
- Wise, R. A. & Rompre, P. P. (1989) Brain dopamine and reward. *Annual Review of Psychology* 40:191–225. [DAP]
- Witt, D. M. (1995) Oxytocin and rodent sociosexual responses: From behavior to gene expression. *Neuroscience and Biobehavioral Reviews* 19(2):315–24. [aRAD]
- (1997) Regulatory mechanisms of oxytocin-mediated sociosexual behavior. *Annals of the New York Academy of Sciences* 807:287–301. [aRAD]
- Witt, D. M. & Insel, T. (1991) Selective oxytocin antagonist attenuates progesterone facilitation of female sexual behavior. *Endocrinology* 128:3269–76. [aRAD]
- Witt, D. M., Carter, C. & Walton, D. (1990) Central and peripheral effects of oxytocin administration. *Physiology and Behavior* 37:63–69. [aRAD]
- Witt, D. M., Winslow, J. T. & Insel, T. (1992) Enhanced social interaction in rats following chronic, centrally infused oxytocin. *Pharmacology, Biochemistry, and Behavior* 43:855–61. [aRAD]
- Wolterink, G., Cadore, M., Wolterink, I., Robbins, T. & Everitt, B. (1989) Involvement of D1 and D2 receptor mechanisms in the processing of reward-related stimuli in the ventral striatum. *Society of Neuroscience* 15:490. [aRAD]
- Wright, C., Beijer, A. & Groenewegen, H. (1996) Basal amygdaloid complex afferents to the rat nucleus accumbens are compartmentally organized. *Journal of Neuroscience* 16:1877–93. [aRAD]
- Wyvell, C. L. & Berridge, K. C. (2000) Intra-accumbens amphetamine increases the conditioned incentive salience of sucrose reward: Enhancement of reward “wanting” without enhanced “liking” or response reinforcement. *Journal of Neuroscience* 20: 8122–30. [aRAD]
- Yamamoto, Y., Cushing, B. S., Kramer, K. M., Epperson, P. D., Hoffman, G. E. & Carter, C. S. (2004) Neonatal manipulations of oxytocin alter oxytocin and vasopressin in the paraventricular nucleus of the hypothalamus in a gender-specific manner. *Neuroscience* 125:947–55. [CSC]
- Yoshikawa, T., Shibuya, H., Kaneno, S. & Toru, M. (1991) Blockade of behavioral sensitization to methamphetamine by lesion of hippocampo-accumbal pathway. *Life Sciences* 48(13):1325–32. [aRAD]
- Young, L. J. (1999) Oxytocin and vasopressin receptors and species-typical social behaviors. *Hormones and Behavior* 36:212–21. [aRAD]
- Young, L. J., Lim, M. M., Gingrich, B. & Insel, T. R. (2001) Cellular mechanisms of social attachment. *Hormones and Behavior* 40:133–38. [PO]
- Young, L. J., Nilsen, R., Waymire, K., MacGregor, G. & Insel, T. R. (1999) Increased affiliative response to vasopressin in mice expressing the V1a receptor from a monogamous vole. *Nature* 400:766–68. [aRAD]
- Young, L. J., Wang, Z. & Insel, T. R. (1998) Neuroendocrine bases of monogamy. *Trends in the Neurosciences* 21:71–75. [aRAD]
- Yu, G., Stowe, Z. & Insel, T. R. (1997) Intraventricular injections of oxytocin excite VTA dopamine neurons in male rats. *Society for Neuroscience Abstracts* 23:418. [aRAD]
- Zak, P. J. (2003) Trust. *Capco Institute Journal of Financial Transformation* 7:13–21. [PJZ]
- Zak, P. J. & Knack, S. (2001) Trust and growth. *Economic Journal* 111:295–321. [PJZ]
- Zak, P. J., Kurzban, R. & Matzner, W. T. (2004) The neurobiology of trust. *Annals of the New York Academy of Sciences* 1032:224–27. [PJZ]
- Zamanillo, D., Sprengel, R., Hvalby, O. & Lang, F. (1999) Importance of AMPA receptors for hippocampal synaptic plasticity but not for spatial learning. *Science* 284:1805–11. [aRAD]
- Zhang, W. & Linden, D. J. (2003) The other side of the engram: Experience-driven changes in neuronal intrinsic excitability. *Nature Reviews Neuroscience* 4:885–900. [aRAD]
- Zhang, X., Hu, X., White, F. & Wolf, M. (1997) Increased responsiveness of ventral tegmental area dopamine neurons to glutamate after repeated administration of cocaine or amphetamine is transient and selectively involves AMPA receptors. *Journal of Pharmacology and Experimental Therapeutics* 281:699–704. [aRAD]
- Zizzo, D. J. (2002a) Between utility and cognition: The neurobiology of relative position. *Journal of Economic Behavior and Organization* 48:71–91. [DJZ]
- (2002b) Neurobiological measurements of cardinal utility: Hedonimeters or learning algorithms? *Social Choice and Welfare* 19:477–88. [DJZ]
- (2003) Empirical evidence on interdependent preferences: Nature or nurture? *Cambridge Journal of Economics* 27:867–80. [DJZ]
- Zlotnick, C., Kohn, R., Keitner, G., Della Grotta, S. A. (2000) The relationship between quality of interpersonal relationships and major depressive disorder: findings from the National Comorbidity Survey. *Journal of Affective Disorders* 59:191–225. [DAP]
- Zubieta, J.-K., Ketter, T. A., Bueller, J. A., Xu, Y., Kilbourn, M. R., Young, E. A. & Koeppe, R. A. (2003) Regulation of human affective responses by anterior cingulate and limbic μ -opioid neurotransmission. *Archives of General Psychiatry* 60:1145–53. [aRAD, JP]
- Zubieta, J.-K., Smith, Y., Bueller, J., Xu, Y., Kilbourn, M., Jewett, D., Meyer, C., Koeppe, R. & Stohler, C. (2001) Regional μ opioid receptor regulation of sensory and affective dimensions of pain. *Science* 293:311–15. [aRAD]
- Zuckerman, M. (1979) *Sensation seeking: Beyond the optimal level of arousal*. Erlbaum. [MZ]
- (1984) Sensation seeking: A comparative approach to a human trait. *Behavioral and Brain Sciences* 7:413–71. [MZ]
- (1990) The psychophysiology of sensation seeking. *Journal of Personality* 58:313–45. [MZ]
- (1991) *Psychobiology of personality*. Cambridge University Press. [aRAD, MZ]
- (1994a) An alternative five-factor model for personality. In: *The developing structure of temperament and personality from infancy to adulthood*, ed. C. Halverson, G. Kohnstamm & R. Marten. Erlbaum. [aRAD]
- (1994b) *Behavioral expressions and biosocial bases of sensation seeking*. Cambridge University Press. [MZ]
- (2002) Personality and psychopathy: Shared behavioral and biological traits. In: *The neurobiology of criminal behavior*, ed. J. Glicksohn, pp. 27–49. Kluwer Academic. [MZ]
- Zuckerman, M. & Como, P. (1983) Sensation-seeking and arousal systems. *Personality and Individual Differences* 4:381–86. [MRM]
- Zuckerman, M., Murtaugh, T. T. & Siegel, J. (1974) Sensation seeking and cortical augmenting-reducing. *Psychophysiology* 11:535–42. [MZ]