

# The detection and generation of sequences as a key to cerebellar function: Experiments and theory

## Valentino Braitenberg

Max-Planck-Institute for Biological Cybernetics, 72076 Tuebingen, Germany

Electronic mail: [schuez@sunwan.mpib-tueb.mpg.de](mailto:schuez@sunwan.mpib-tueb.mpg.de)

## Detlef Heck

University of Freiburg, Institut für Biologie III, Neurobiology and Biophysics, D-79104 Freiburg i. Br., Germany.

Electronic mail: [heck@biologie.uni-freiburg.de](mailto:heck@biologie.uni-freiburg.de)

## Fahad Sultan

Sektion für Visuelle Sensomotorik, Neurologische Universitätsklinik Tuebingen, 72076 Tuebingen, Germany.

Electronic mail: [fahad.sultan@uni-tuebingen.de](mailto:fahad.sultan@uni-tuebingen.de)

**Abstract:** Starting from macroscopic and microscopic facts of cerebellar histology, we propose a new functional interpretation that may elucidate the role of the cerebellum in movement control. The idea is that the cerebellum is a large collection of individual lines (Eccles's "beams": Eccles et al. 1967a) that respond specifically to certain sequences of events in the input and in turn produce sequences of signals in the output. We believe that the sequence-in/sequence-out mode of operation is as typical for the cerebellar cortex as the transformation of sets into sets of active neurons is typical for the cerebral cortex, and that both the histological differences between the two and their reciprocal functional interactions become understandable in the light of this dichotomy.

The response of Purkinje cells to sequences of stimuli in the mossy fiber system was shown experimentally by Heck on surviving slices of rat and guinea pig cerebellum. Sequential activation of a row of eleven stimulating electrodes in the granular layer, imitating a "movement" of the stimuli along the folium, produces a powerful volley in the parallel fibers that strongly excites Purkinje cells, as evidenced by intracellular recording. The volley, or "tidal wave," has maximal amplitude when the stimulus moves toward the recording site at the speed of conduction in parallel fibers, and much smaller amplitudes for lower or higher "velocities." The succession of stimuli has no effect when they "move" in the opposite direction. Synchronous activation of the stimulus electrodes also had hardly any effect.

We believe that the sequences of mossy fiber activation that normally produce this effect in the intact cerebellum are a combination of motor planning relayed to the cerebellum by the cerebral cortex, and information about ongoing movement, reaching the cerebellum from the spinal cord. The output elicited by the specific sequence to which a "beam" is tuned may well be a succession of well timed inhibitory volleys "sculpting" the motor sequences so as to adapt them to the complicated requirements of the physics of a multijointed system.

**Keywords:** allometric relation; cerebellum; cerebrocerebellar interaction; motor control; parallel fibers; sequence addressable memory; spatiotemporal activity; synchronicity

## 1. Introduction

We will present experiments and observations aimed at an explanation of the peculiarities of cerebellar structure. Of course such an explanation will have recourse to general ideas on the function of the cerebellum in the global sensorimotor control of the organism, and may in turn contribute to a more precise definition of that function. Our main point, however, is that there is information in structure; neuroanatomy may profitably be consulted when other kinds of evidence fail to provide decisive clues.

Some computational schemes proposed as models of cerebellar function were embarrassingly close to similar

models proposed for the cerebral cortex, and so we shall start with a comparison of the two cortices, with special emphasis on the differences.

## 2. Size and number of neurons

Compared to the "large brain," the "small brain" is small only in volume, not in the surface of its cortex and even less in its linear extension. The anteroposterior length of the flattened cerebellar cortex of man exceeds two meters, that of the cow measures three meters, and that of the mouse 4 cm. Compare this to the diameter of the (roughly circular) flattened cerebral cortex of one hemisphere, which is 0.3 m in man and 1 cm in the mouse. The surface

of the cerebellar cortex is about the size of one hemisphere of the telencephalic cortex.

The number of neurons is of the same order of magnitude ( $10^{10}$ ) in both cortices. Since both the surface and the number of neurons can be taken as a rough estimate of the information handling capacity of a cortical structure, we may conclude that the complexity of the task of the cerebellar cortex matches that of the telencephalic cortex.

### 3. Isotropic versus anisotropic connections

A peculiarity of the cerebellar cortex, known since the early Golgi studies (Ramón y Cajal 1911) is the lattice-like arrangement of its elements in the cortical neuropil. The great majority of axons and dendrites in the molecular layer, if their course is projected onto the plane of the cortex, run either in the anteroposterior or in the laterolateral direction. The distinction of two orthogonal directions in the cerebellar cortex is especially impressive if the physiological characteristics of the axons are considered, because the only axons running in the transversal direction, the parallel fibers, are excitatory, while the axons running at right angles to them belong exclusively to inhibitory interneurons.

The only notable exception is the (inhibitory) Golgi cell. Its dendritic and axonal ramifications occupy roughly circular territories in the cortical plane. Although the other neuronal elements of the cerebellar cortex either shift signals laterolaterally or inhibit activity to the front and to the back of them, Golgi cells are local operators. They seem to put a brake, then and there, on the activity of other cerebellar neurons and of afferent fibers when it exceeds a critical level.

In contrast to the cerebellum, the weave of the cerebral cortex is isotropic. There are no preferred directions (barring exceptional situations at the borders between some areas) and there is no geometrical separation of excitatory and inhibitory fibers.

### 4. Lack of excitatory loops

There are no neuronal connections within the cerebellar cortex that could sustain positive feedback. The only intrinsic excitatory neurons, the granule cells, only contact inhibitory neurons (intrinsic: stellate and basket cells; efferent: Purkinje cells) and never other neurons of their own kind. Thus a prerequisite for an explosive build up of excitatory activity is missing in the cerebellar cortex. Nor can external loops be excitatory, because the only output of the cerebellar cortex, provided by Purkinje cell axons, is inhibitory (unless one postulates a complicated scheme involving serial inhibition and spontaneously active elements).

This is in striking contrast to the situation in the telencephalic cortex. There, the kind of synapse prevailing statistically over all the other kinds is one connecting excitatory pyramidal cells to other excitatory pyramidal cells (Braitenberg & Schüz 1991). There is a sheer infinite number of excitatory loops preformed in the neuropil of the cerebral cortex, and this may well be the key to an explanation of that structure. (A side effect of this is, of course, the proneness of the cerebral cortex to lapse into epileptic seizures.)

### 5. Local operation

Intracortical fibers of the cerebellum run a few millimeters in the laterolateral direction, somewhat less in the anteroposterior direction. There are no corticocortical fibers leaving the cerebellar cortex through the white substance in order to reenter it in another place. Therefore the operation that the cerebellar cortex performs on its input must be strictly local, limited to a region a few millimeters in size. Or, to put it differently, the output of the cerebellar cortex at any one point can only be influenced by the input a few millimeters away.

Again, this is in contrast with one of the most striking structural properties of the cerebral cortex. The anatomy of the telencephalic hemispheres strongly suggests a global operation, since from any point of the cortex there is a wealth of connections to nearby and distant parts of the cortex, including connections to the opposite hemisphere. This, by the way, is one of the reasons why the large brain is larger than the small brain: much of its bulk is due to the large number of corticocortical fibers in the white substance. The slim white substance of the cerebellar hemispheres contains only afferent and efferent fibers.

### 6. Lack of separation of the hemispheres

The cerebellar cortex is one of the very few parts of the nervous system that shows no discontinuity at the midline. The cortical neuropil is continued without interruption between the hemispheres, the interaction between two points on either side of the midline presumably being exactly the same as between two points on one side.

In contrast, the telencephalic cortex consists of two separate hemispheres, joined by the fibers of the corpus callosum, but not by continuous neuropil.

### 7. Orientation of the folds in one direction only

The anisotropy of the cerebellar cortex manifests itself even macroscopically. The folds that become necessary when a large surface is to fit into a small cranium have a tendency, as in the cerebellum, to run in one direction only. The consequence of this is that distances between the histological elements are not distorted by the folding along the direction of the folds, in the direction of parallel fibers.

The situation is quite different in the telencephalic cortex where the folds, in larger brains, seem to run in all directions indiscriminately, and distances between neighboring neurons are thereby freely stretched or compressed.

### 8. Morphological commentary

If anatomy is viewed in the spirit of "computer architecture," we may rephrase the above statements in computational terms and thereby obtain first hints at a theory of cerebellar function.

The cerebellar cortex is essentially "feed forward." Patterns of activity in the input are transformed into patterns of active output fibers through different sets of internal neurons which do not involve intracortical excitatory recurrent loops. The most numerous kind of inter-

neurons, the granular cells, simply shift signals through their axonal branches (the parallel fibers) from their origin in the input in opposite directions along the laterolateral coordinate of the cortex at a low and fairly constant speed. Thus output neurons will be relaying input signals that arrived at different times in the past in different places – the farther back in time, the farther away their origin.

This being presumably the most important aspect of input–output transformation in the cerebellar cortex, we may assign a merely ancillary role to the fibers oriented in the other, the anteroposterior direction. These fibers are inhibitory and simply suppress activity on either side of a particularly active “beam of parallel fibers.”

This view implies that the *one-dimensional beam* is the computational unit in the cerebellar cortex. The neuronal equipment of a laterolateral strip of cortex, consisting of parallel fibers each contacting a row of Purkinje cells (and conversely, Purkinje cells collecting signals from granular cells situated at various distances) suggests that one-dimensional spatiotemporal patterns are the adequate input to the cerebellar cortex.

If the laterolateral beam is responsible for the cerebellar response to one spatiotemporal pattern, the anteroposterior extension of the cerebellar cortex must be related to the number of such beams, or to the number of patterns that can be distinguished.

In the light of this, the macroscopical shape of the (unfolded) cerebellar cortex becomes important. The width of the flattened cortex should be related to the length of the sequences that are elaborated there, whereas the anteroposterior extension may have something to do with the variety of patterns.

### 9. Comparative study of the flattened cerebellar cortex. (Sultan 1994a; Sultan & Braitenberg 1993)

Sultan (1994a) compared the cerebella of 14 species of mammals and of one bird. For each species he reconstructed the outline of the cerebellar cortex by counting the number of folia, measuring the length of the folia and their anteroposterior extension. Histological analysis was used when there were doubts about the continuity of the cortex, for example, between its vermal and hemispheric portions.

The results are illustrated in Figures 1 and 2. Figure 1 shows the folial pattern, for selected species (macaque, sheep, dog, bat). Each horizontal line represents the length of one folium; neighboring lines represent neighboring folia; interrupted lines represent two folia which are not continuous. In Figure 2, the folial patterns of three large cerebella (a: bovine, b: human, c: ovine) and three small cerebella (not to scale, d: squirrel, e: rabbit, f: mouse) are transformed into outline drawings in which length and width are shown in the correct proportions.

The simple inspection of these shapes does not lead to any intuitive interpretation. There is a common characteristic, valid for all mammals (not for the bird), namely, a distinction of an anterior part in which the folial pattern is continuous between right and left, a posterior region in which the cerebellar cortex is split in three parts, a median part (the posterior vermis), and two tailed extensions of the hemispheres. It is of course tempting to associate the anterior unsplit section with such computations that in-

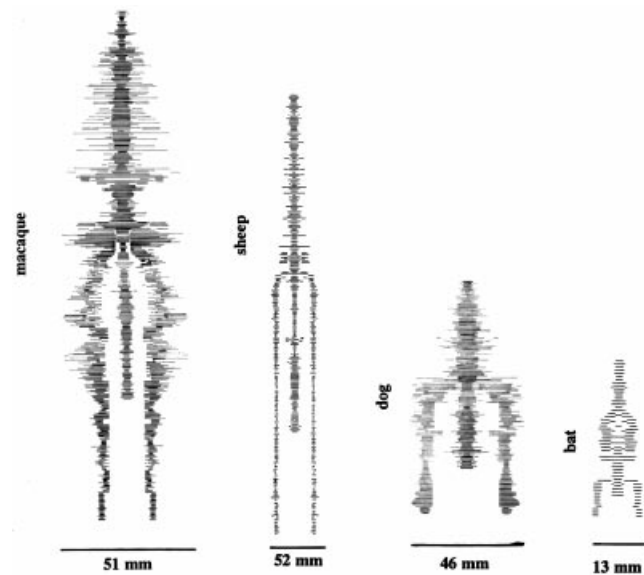

Figure 1. Folial patterns of the cerebella of the macaque, sheep, dog, and bat. Each horizontal line represents the length of the folium in the laterolateral direction. The number of lines represents the anteroposterior direction, although not at the same scale as the laterolateral direction; compare Figure 2. (Modified from Sultan & Braitenberg 1993.)

volve the whole body bilaterally, and the posterior paired extensions with paired and relatively independent parts of the body such as the extremities. The median posterior extension would then be associated with axial parts of the body, which act in relative isolation from the limbs.

The comparison of the overall anteroposterior and laterolateral extension of the cerebellar sheet in different animals is puzzling. If the width represents the duration of the longest sequences that the cerebellum can digest, the human cerebellum beats all the others in this respect (we have no cetaceans in our collection, which according to Riley [1928] have particularly wide cerebella). The comparison of the human and bovine cerebellum indicates that the length of motor programs is not so much related to the bulk of the body but rather to their sophistication. But if the overall length of the cerebellum represents variety of motor programs, we cannot explain why the bovine cerebellum is the longest.

A quantitative analysis of the comparative data (Sultan 1994a; Sultan & Braitenberg 1993) with the methods of allometry (Jerison 1973) does not yield much more insight. Like the weight of the brain as a whole, the weight of the surface of the cerebellar cortex, because of its fairly uniform thickness, is roughly proportionate to the  $2/3$  power of the weight of the body (Fig. 3), confirming the parallel evolution of large and small brain already mentioned. The increase in surface of the cerebellar cortex with body size is mainly due to an increase in width for the smaller species, while in the larger species the length increases disproportionately (Fig. 4). In many of the allometric relationships investigated, the human cerebellum appears as a stray point, mainly because of its great width.

One should like to know more about topographic and other maps on the surface of the cerebellum in order to make more sense of the comparative anatomy. This is a

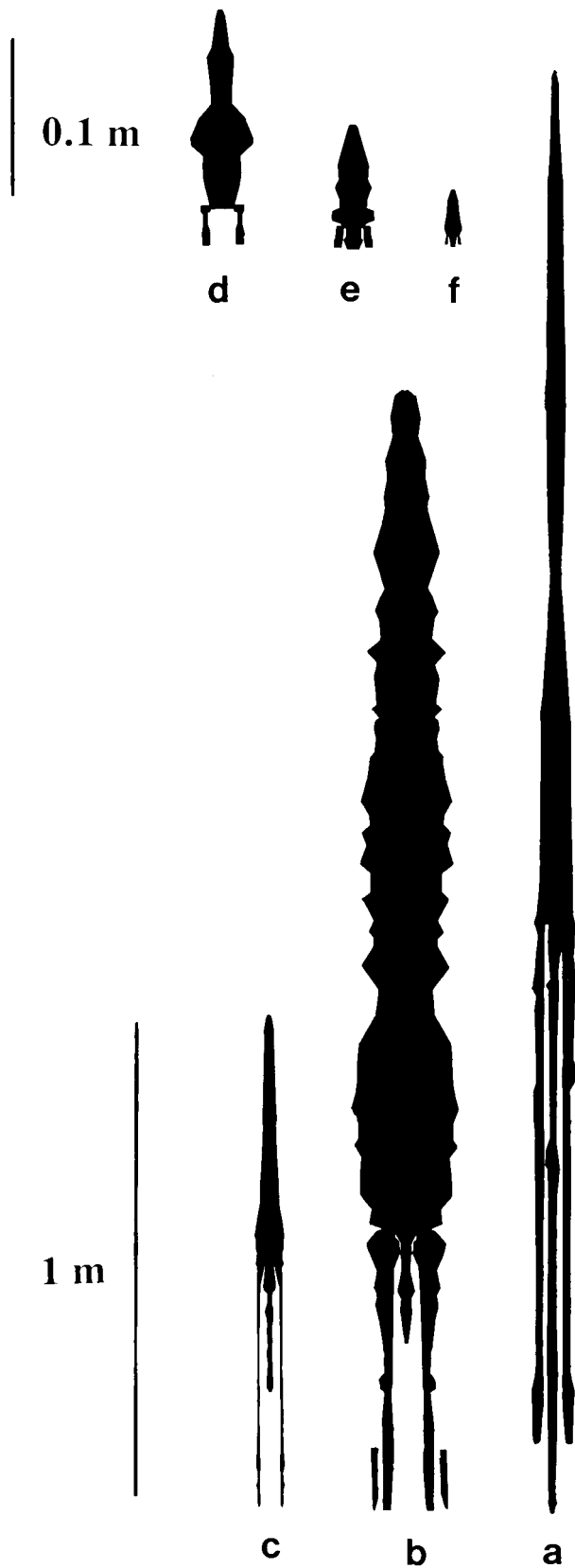

Figure 2. The shape of the unfolded cerebellar cortex of three large animals (a: bovine; b: human; c: macaque) and three small animals (d: squirrel; e: rabbit; f: mouse). Note the different scale of the large and the small cerebella. The anteroposterior extension of both the human and the bovine cerebellum exceeds two meters. (Modified from Sultan & Braitenberg 1993.)

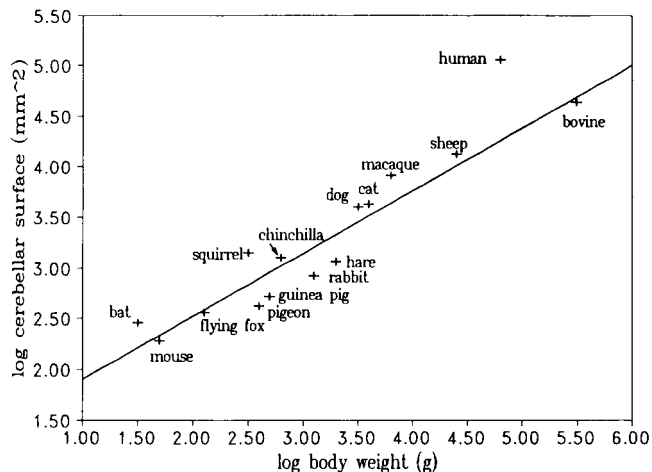

Figure 3. The logarithm of the cerebellar surface (mm<sup>2</sup>) is plotted against the logarithm of body weight (gram). The regression line has a slope of 0.62 (without the human cerebellum), indicating a dependence of the cerebellar surface on the 2/3 power of body weight. Note that the human cerebellum appears as a stray point. (Sultan & Braitenberg 1993.)

lacuna which makes itself felt in several contexts. The main obstacle to comprehensive mapping studies is the complicated folding of the cerebellar cortex, with only a small proportion of it available for investigation from the surface.

### 10. The basic unit of computation in the cerebellar cortex

Since we have already seen that the interaction of signals within the cerebellar cortex is limited to a region measuring only a few millimeters in either direction, it should be possible to give a complete description of the effects that the input signals have on each output neuron within that small region. The global operation could then be taken simply as the sum of these local effects. A complete

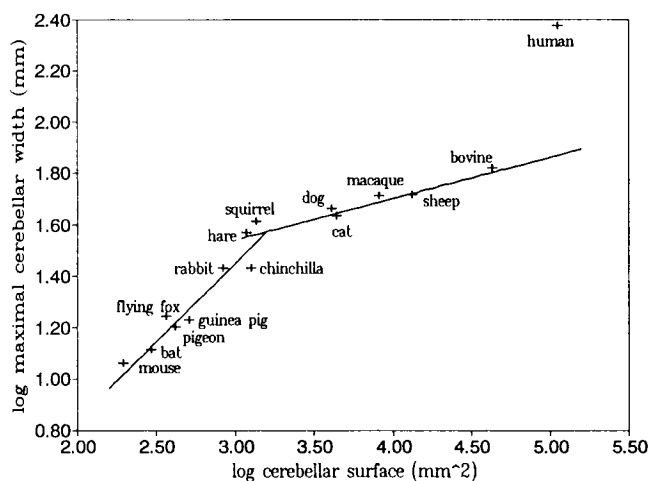

Figure 4. Maximal cerebellar width plotted against the cerebellar surface on a log-log scale. The dependence is steeper for the smaller cerebella than for the larger ones. Again, the human cerebellum is a stray point. (Sultan & Braitenberg 1993.)

description, of course, implies sufficient knowledge of the physiological properties of neurons and synapses and it will be our next task to review the available information on this point.

Purkinje cells are the output elements of the cerebellar cortex. Their number in the human cerebellum is given as 15,000,000 (Braitenberg & Atwood 1958; Mayhew 1991), or 30,000,000 (Andersen et al. 1992), in the rat as about 300,000 (Harvey & Napper 1988; Mayhew 1991). Their axons are inhibitory (Ito & Yoshida 1964; 1966; Ito et al. 1964; 1970) and terminate for the most part in the cerebellar nuclei and in the vestibular nuclei (Brodal 1981; Eccles et al. 1967a), depending on their location in the cerebellum. Besides their terminations outside the cerebellar cortex, Purkinje cell axons have collaterals that terminate in neighboring regions of the cerebellar cortex itself, mainly on the perikarya of other Purkinje cells (Palay & Chan-Palay 1974; Ramón y Cajal 1911), but also on basket cells (Lemkey-Johnston & Larramendi 1968; Leranath & Hámori 1981).

The dendritic tree of the Purkinje cell is the seat of close to 200,000 synapses most of which (160,000 in the rat; Napper & Harvey 1988) are localized on dendritic spines. The majority of these synapses are classified as excitatory both on electronmicroscopic (Gray 1961) and electrophysiological (Eccles et al. 1966) evidence. The vast majority of the excitatory synapses on the dendritic tree of Purkinje cells is provided by the axons of granular cells. The others stem from climbing fibers.

There are also inhibitory synapses on Purkinje cells, both on the dendritic tree and on the soma. Most of them come from two kinds of inhibitory interneurons, the stellate cells and the basket cells.

The very large number of synapses on the dendritic trees of Purkinje cells should be compared to the number of synapses on cortical pyramidal cells. Even the largest pyramidal cells do not quite come up to one tenth of the number of synapses on Purkinje cells. This is a feature which has never been explained in a satisfactory way. It is partly responsible for the ideas of those (Cohen & Wu 1990; Hounsgaard 1989; Hounsgaard & Midtgaard 1989; Ross et al. 1990) who like to see the dendritic tree of Purkinje cells as a complex machine, itself capable of logical operations of the kind that are usually attributed to neuronal networks, not to single neurons.

A physiological peculiarity of Purkinje cells is their high firing rate under resting conditions, or rather, under conditions where no controlled stimulus is applied (Thach 1970; 1972). Recording in monkeys during spontaneous movements, an average firing rate of about 40 spikes per second is seen to vary both upward and downward in relation to certain phases of the movement (Fortier et al. 1989; Harvey et al. 1977).

Another special feature is the "complex spike," a multiphasic event that involves the membrane potential of Purkinje cells in a standardized fashion. These complex spikes are clearly distinct from the ordinary, so-called simple spikes and occur with a much lower frequency of about 1 per second (Harvey et al. 1977; Thach 1972).

Besides the spinal motoneuron, there is hardly a cell in the vertebrate nervous system that has been studied as extensively as the Purkinje cells from a biophysical angle (e.g., Gähwiler & Llano 1989; Hockberger et al. 1989; Hounsgaard & Midtgaard 1988; Konnerth et al. 1990;

Llano et al. 1991; Llinás & Sugimori 1980; Midtgaard et al. 1993; Regan 1991; Torres-Aleman et al. 1992). We shall not review these results here, because, as important as they undoubtedly are, we believe they are not essential to the argument we want to present.

## 11. Influences of other neurons on Purkinje cells

It seems certain that complex spikes in Purkinje cells are the exclusive result of presynaptic climbing fiber activation (Campbell et al. 1983; Colin et al. 1980; Ekerot & Oscarsson 1981). The special neuronal response may be due to the especially intimate anatomical relation between each Purkinje cell and the associated climbing fiber, but may also indicate a particular selection of membrane channels which are under the influence of the climbing fiber (Knöpfel et al. 1991).

The other excitatory influence on the Purkinje cell comes through the hundreds of thousands of contacts provided for each cell by the parallel fibers. There has been some discussion about the relative merits of the synapses which the ascending granular cell axons make with the Purkinje cells, and those made by the two branches, the parallel fibers proper (Bower & Woolston 1983; Llinás 1982). Numerically the synapses on the parallel fibers prevail (Napper & Harvey 1988; Sultan & Rotter 1994). Moreover, in the case of parallel fibers that lie low in the molecular layer, the ascending branches connecting them with their parent granular cells cannot contact any Purkinje cells at all.

There is some anatomical evidence suggesting that parallel fibers situated low in the molecular layer are thicker than the ones above, and this corresponds also to some electrophysiological measurements (Heck 1993; 1995c; Nicholson & Llinás 1971) showing different conduction velocities at different depths in the molecular layer. This may be important for a refinement of the theory that we will develop in this paper, but will be ignored at the present stage. This is justified by the observation that the global behavior of the mass of parallel fibers in the molecular layer is as if they all conducted spikes at the same velocity.

It is well known that granular cells in turn receive their excitatory input mainly (if not exclusively) from the mossy fibers (Brodal 1981; Desclin & Colin 1980; Mason & Gregory 1984). Thus Purkinje cell activity reflects activity in the two great systems of input fibers to the cerebellum, monosynaptically in the case of climbing fibers, bisynaptically through the mossy fiber-granular cell channel. Both systems are present everywhere throughout the entire extent of the cerebellar cortex, presumably with equal density.

There is an important difference in the way excitation reaches Purkinje cells through the two channels. In the case of the mossy fiber-granular cell-parallel fiber input, the points of arrival on the dendritic membrane are the dendritic spines, while no such preference is apparent in the climbing fibers. In cerebral cortical as well as hippocampus physiology the opinion is widespread that synapses on spines may be plastic, that is, subject to modification by learning (for a recent review see Horner 1993). If this were confirmed, we would have a strong indication of the parallel fiber-Purkinje cell connection as the seat of

memory in the cerebellum. Climbing fibers would then be assigned a more direct, preset function, in tune with the standardized response climbing fibers elicit in Purkinje cells.

The inhibitory influences on Purkinje cells have been observed both in intracellular (Crépel 1974; Konnerth et al. 1990; Midtgaard 1992) and extracellular (Eccles et al. 1967b) recording. They are mediated mainly by two classes of interneurons which are distinguished by their point of arrival on the somatodendritic membrane of the Purkinje cell. Basket cells surround with their terminations the perikaryon and the initial segment of the Purkinje cell axon, while stellate cells tend to terminate on the dendritic tree. They are otherwise very similar in the length and geometrical distribution of their axons in the cortical plane (Sultan & Bower 1996), in the shape of their own dendritic trees and in their synaptic relations (Palay & Chan-Palay 1974; Rakic 1972). Both kinds of inhibitory interneurons are fed excitation through the same mossy fiber – granular cell – parallel fiber channel that also serves the Purkinje cell, with the difference, however, that parallel fibers contact the dendrites of inhibitory interneurons directly, those of Purkinje cells through spines.

The Golgi cell, the third type of inhibitory interneuron has more complex synaptic relations. As we have mentioned already, their role seems to be essentially to check excess local activity. They are therefore not directly involved in the spatiotemporal transformations which are at the center of our attention. They are a striking exception to the anisotropy of the network formed by Purkinje, stellate, basket, and granular cells.

## 12. Geometry of the arrangement of input elements around Purkinje cells

In no other part of the nervous system does the shape of neuronal elements suggest their functional relations as clearly as in the cerebellar cortex. The dendritic tree of Purkinje cells in all species studied (excepting perhaps the most rudimentary cerebella such as those of cyclostomes; Ariëns Kappers et al. 1936; Johnston 1902a; 1902b) extends much farther in the anteroposterior direction than in the direction at right angles to it. In the human cerebellum, for example, the dendritic tree of individual Purkinje cells is contained in a rectangular block measuring about 350  $\mu\text{m}$  in the vertical direction  $z$  (corresponding to the thickness of the molecular layer), about as much in the anteroposterior direction  $y$  (the direction perpendicular to the folia), but only about 35  $\mu\text{m}$  in the laterolateral direction  $x$  (the direction along the folia).

(For reasons of word economy we will use the  $x$ ,  $y$ ,  $z$  frame from here on. Another reason for using the intrinsic coordinates of the cerebellar cortex rather than the body coordinates right-left, forward-backward, up-down is that the two frames of reference do not coincide in large parts of the cerebellum. In the posterior vermis, which in many species is tucked under the body of the cerebellum, the  $y$  coordinate is actually inverted with respect to the “forward” coordinate of the body, and the  $z$  coordinate, the “vertical” in the histological jargon, almost nowhere corresponds to the vertical of the body, due to the folding of the cerebellar cortex.)

The rectangular boxes containing the dendritic trees of individual Purkinje cells are quite separate from each

other, the overlap between the territories of one cell and its neighbors being very small or nonexistent both in the  $x$  and  $y$  direction. This again is a rare exception among the various kinds of neuropil which have been studied with Golgi and similar methods. Almost everywhere, very notably in the cerebral cortex, dendritic trees are intermingled, each overlapping the territories of thousands of other dendritic trees. In the cerebellum they seem to keep out of each other's way. In the cerebral cortex the “relative dendritic density” (Braitenberg & Schüz 1991) of pyramidal cells, that is, the ratio of the dendritic length of one neuron to the total dendritic length present in the territory of its ramification is about 1:1000. In the cerebellum the same ratio, for Purkinje cells as well as stellate and basket cells is close to 1:1.

The neatly separated flat dendritic trees of Purkinje cells (and stellate cells) acquire a special meaning in connection with the peculiar geometry of the axonal fiber felt in which they are embedded. The bulk of the axonal fiber population in the molecular layer is provided by the parallel fibers which all run in the  $x$  direction, that is, perpendicular to the  $y$ ,  $z$ -plane in which the dendrites of their target neurons ramify. The whole arrangement seems to imply that for each dendritic tree there is a predetermined place along the length of the parallel fibers at which it is to receive its synaptic input. The idea that what really matters is the time at which the synapses become active is old but still enticing.

## 13. Rise and fall of the timing hypothesis

Although the original proposal (Braitenberg & Atwood 1958) was phrased in rather general terms (“transformation of spatial into temporal patterns and vice versa,” “activity . . . will reach different Purkinje cell trees after different time intervals, depending on their distance,” “arrival of a front of activity at any one Purkinje cell implies activity at different loci at different times in the past”), the version that met with most favor (Braitenberg 1961; 1965; Braitenberg & Onesto 1962; Kornhuber 1974) was that which sees parallel fibers as generators of time delays between the activation of different muscles involved in one movement. And this was also the most vulnerable form of the timing hypothesis, since with the known length of parallel fibers of a few millimeters and the measured velocity of conduction of about 0.5 m/sec (Eccles et al. 1967a) the delays generated could hardly be more than 10 msec. This is not enough for the timing of movements which typically take about 200 or 300 msec for their completion.

Moreover, the vague hope that some internal circuitry could perhaps relay signals from one delay line to the next in order to generate the longer delays was thwarted by the finding (Eccles et al. 1967a) that, except for the granular cells/parallel fibers themselves, all interneurons in the cerebellar cortex are inhibitory.

## 14. Tidal waves

An alternative scheme (Braitenberg 1983; 1987) was therefore proposed that makes use of the special geometry of the cerebellar cortex without incurring the difficulties

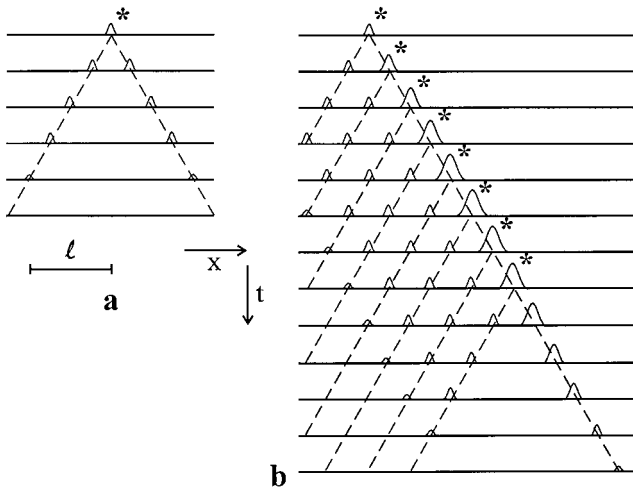

Figure 5. (a) The effect of a short local stimulus (asterisk) to the cerebellum in time and in space. The laterolateral direction of the cerebellum is plotted horizontally and time in the direction up-down. The horizontal line represents a succession of points in time. The wave set up by the stimulus travels in both directions and dies out after it has moved the length  $l$ , corresponding to one branch of the parallel fiber. (b) If a succession of stimuli (asterisks) imitating movement along the folium is presented, summation of activity in the parallel fiber system occurs. A wave of maximal amplitude builds up when the stimuli follow each other at the velocity  $v_0$  of conduction in the parallel fibers. After cessation of the stimuli, the tidal wave setup continues for the length  $l$  with diminishing amplitude and then dies out.

which made the timing hypothesis obsolete in its original form. The emphasis is on conduction velocity rather than on time intervals. The idea is as follows:

We stylize the molecular layer of the cerebellar cortex as a tissue that conducts signals along the direction  $+x$  and  $-x$  at the velocity  $v_0$ , the velocity of conduction in parallel fibers (dashed lines, Fig. 5a). A small patch of excitation at one point (asterisk) produces two waves running in opposite directions, quickly exhausted because of the limited length of parallel fibers. The density of excitation is nowhere very great, since the parallel fibers which are fed by the input at any point are only a small fraction of all the parallel fibers present there, due to their staggered arrangement. In fact, at a location  $x, y$  in the molecular layer all the parallel fibers converge which have their parent granular cells located within a range of  $x - l, y$  and  $x + l, y$ , where  $l$  is the length of each branch of a parallel fiber. Today's estimates for  $2l$  vary between 4.7 and 6 mm (Brand et al. 1976; Harvey & Napper 1988; Mugnaini 1976; 1983; Pichitpornchai et al. 1994; Schild 1980).

The situation is different for moving input (Fig. 5b). Suppose a patch of input excitation moves in the direction  $x$  at the velocity  $v_0$  (asterisks). Then each new input will add excitation to that already travelling in the parallel fibers, and the density of excitation in the travelling wave, or tidal wave, will increase up to a maximum when all the available parallel fibers participate in the wave. This maximum is reached after the input has travelled for a distance  $l$ , and the density of excitation stays constant thereafter if the movement of the input continues in the same direction at the same speed.

The maximum density of excitation in the travelling

wave corresponds to an activation of one half of all the synapses provided by parallel fibers, since only the branches of the parallel fibers running in the direction in which the wave moves contribute excitation to the wave. The signals running in the opposite direction are dispersed and stay behind the wave. Activation of all the parallel fiber synapses in the molecular layer would be possible only if moving input converges from opposite directions creating two waves that cross each other.

The supposition that tidal waves arise in the cerebellar cortex is a simple consequence of anatomy and can hardly be otherwise, given the basic facts of physiology. Moreover, it is an inescapable conclusion that the local density of excitation  $A$ , the height of the tidal wave so to say, depends critically on the velocity at which the input "moves" along the cerebellar cortex. If  $E$  is the total amount of excitation introduced (say, the number of spikes elicited by the input in the granular cells),  $\Delta x$  is the distance travelled by the input,  $v$  the velocity at which the input moves,  $v_0$  the velocity of conduction in parallel fibers,  $d$  the "wavelength" of the spikes on the parallel fibers (i.e., the duration of the spike multiplied by the velocity of conduction), then the local density of excitation

$$A = \frac{E}{(\Delta x/v) |v - v_0| + d}$$

Figure 6 (from Braitenberg 1993) plots the dependence for two values of  $d$ . Even assuming a wavelength of the spike comparable to the distance travelled by the input, the curve has a sharp peak at the velocity  $v = v_0$  (Fig. 6a). Assuming a shorter wavelength, the dependence on the velocity becomes very critical (Fig. 6b). The realistic values can be assumed to lie somewhere between the case of Figure 6a and that of 6b. Assuming a conduction velocity of 0.5 m/s and a duration of the spikes of about 2 msec, the wave length of spikes in parallel fibers is of the order of one millimeter. The distance over which a tidal wave may build up is the length  $l$  of one branch of a parallel fiber, a few millimeters.

The question is, what sense can we make of the idea of the cerebellum critically tuned to the speed at which certain sequences occur in its input? Before turning to this theoretical problem, we want to assure ourselves that the physiology of the cerebellum does indeed behave in the way we expect from anatomy.

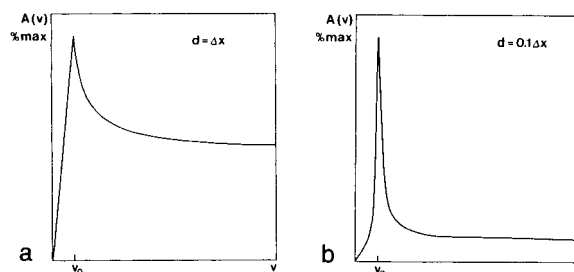

Figure 6. Maximal amplitude of the tidal wave ( $A$ ) as a function of velocity.  $V_0$  is the velocity of conduction in the parallel fibers,  $d$  is the spread of the signal along the parallel fibers (the wave length of the signal), and  $\Delta x$  is the length of the stretch over which the stimulus was presented. In (a) the "wave length" is 10 times that in (b). (Modified from Braitenberg 1993.)

### 15. Experimental verification of tidal waves

The test experiments were performed *in vitro* by Heck (1993; 1995a; 1995b; 1995c) on acute slices of rat cerebellar cortex. The problem was approached in two stages. In a first set of experiments the existence of velocity dependent waves in the molecular layer was demonstrated by extracellular recording. In subsequent experiments the effectiveness of these waves in exciting postsynaptic elements was shown by intracellular recording of Purkinje cells.

Slices 0.4 mm thick were excised from the vermis of 3 to 4 week old rats by means of a vibrotome. The cuts were oriented parallel to the long axis of the folia and usually contained several long sections of the cerebellar cortex cut at different angles with respect to the pial surface. An example is shown in Figure 7. Also shown on the figure are the positions of the tips of 11 stimulating electrodes (white arrow heads) arranged in a row within the granular layer of one of the folia, one cut as nearly perpendicular as possible to the cortical surface. This made it possible to record from the molecular layer overlying the stimulated region of the granular layer and hence presumably containing the parallel fibers belonging to the stimulated granular cells. For details of the slice preparation and of the electrophysiological technique, the original publications (Heck 1993; 1995b; 1995c) should be consulted. The stimulating electrodes were epoxy-insulated tungsten wires spaced at distances of about 130  $\mu\text{m}$ . Negative current pulses of 50  $\mu\text{s}$  duration and current strength of 50 to 500  $\mu\text{A}$  could be passed in any sequence through the stimulating electrodes, with the bathing medium serving as the indifferent electrode. Micropipettes filled with 3M NaCl (tip diameter less than 1  $\mu\text{m}$ , resistance 4 to 9 MW) were used as recording electrodes. Their tips were inserted into the molecular layer about half way between the pial surface and the Purkinje cell layer. The recording electrode was placed in the molecular layer at a position well beyond the end of the row of stimulating electrodes in

the granular layer, at distances ranging from 200 to 1100  $\mu\text{m}$  from the last electrode in the row.

With this arrangement the amplitude and time course of the signal induced in the molecular layer by different sequences of stimuli in the granular layer could be observed. The signal appeared in the form of a biphasic deflection riding on the large stimulus artifact (Fig. 8). The most striking difference was between the response to "movement" of the stimulus toward the recording electrode and "movement" in the opposite direction, away from the recording electrode. In the first case a sizable signal was observed (Fig. 8a), and none in the second (Fig. 8b). Movement was simulated by sequential activation of the stimulating electrodes starting at one end of the row, with delays between one electrode and the next that were variable but constant for each run.

There are two good reasons for believing that the observed signal is indeed due to conduction in parallel fibers. The first reason is pharmacological. The signal is abolished by addition to the bathing medium of the sodium channel blocker tetrodotoxin (TTX), which shows that it is no passive stimulus artifact. The signal persists after application of synaptic blockers such as 6-cyano-7-nitro-quinoxaline-2,3-dione (CNQX), excluding the possibility of some trans-synaptic effect.

The second reason for believing that the signal reveals summation in the system of parallel fibers is its amplitude, which after sequential activation is much larger than after activation of individual stimulating electrodes. The signal due to "movement" toward the recording electrode far exceeds the signal obtained with stimulation of even the stimulating sites closest to the recording electrode. This clearly shows that the activation of more distant stimulating sites also contributes to the phenomenon, most likely through conduction in parallel fibers.

The case becomes even stronger when the dependence of the signal amplitude on the velocity of the "movement" (i.e., on different delays in the stimulating sequence) is taken into consideration. Figure 9 shows this dependence

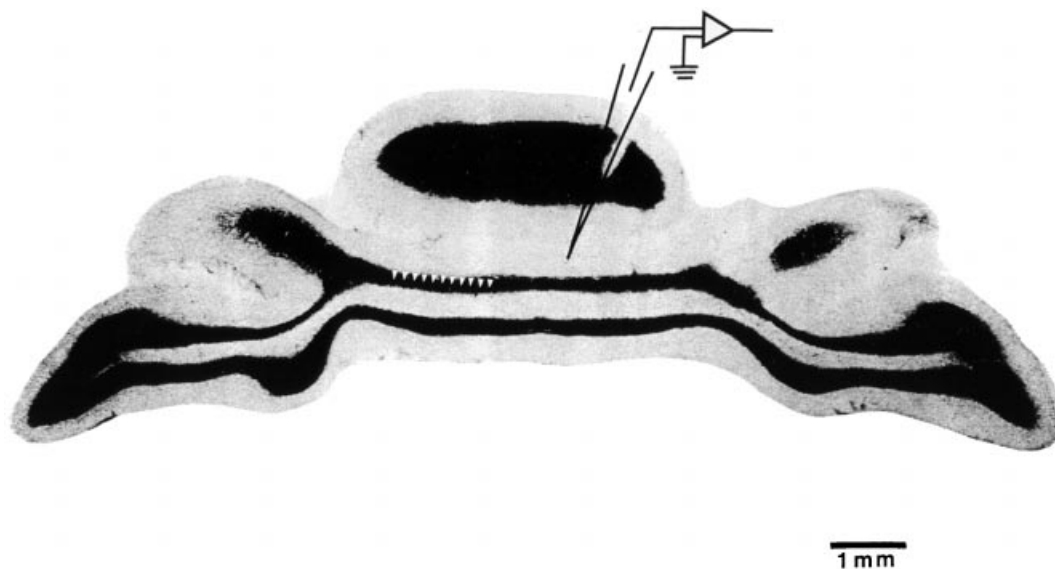

Figure 7. Horizontal section through the rat cerebellum (Nissel-stain). The position of the tips of 11 stimulating electrodes in the granule layer are shown by white arrows. The position of the recording electrode is also indicated.



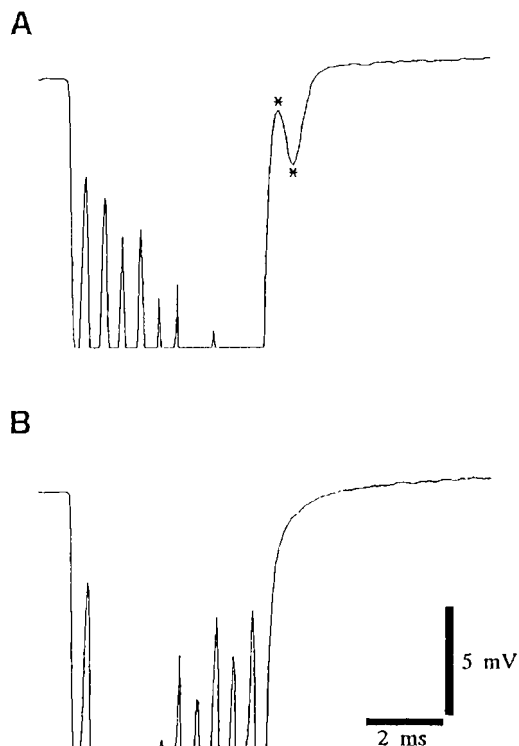

Figure 8. Extracellular recording after sequential stimulation at sites indicated in Figure 7. On the left side of the recording, the stimulus artifacts (negative excursions, clipped by the recording instrument of the 11 stimuli) are shown, which build up into the large negative wave (clipped). As the recorded potential goes back to its resting level, the wave set up by the parallel fiber activity induced by the stimulus (deflection between the two asterisks) is evident in A, where the stimuli moved toward the electrode, and absent in B, where movement was in the opposite direction. (Heck 1993.)

for two experiments on slice preparations from two different animals. In both cases, when “movement toward” was tested, the signal fell below the noise level for velocities smaller than about 0.15 to 0.2 m/sec, or larger than about 0.5 to 0.6 m/sec. The maximum response was obtained for velocities around 0.3 m/sec in one case and 0.4 m/sec in the other. This would imply that in the acute slice of the rat cerebellum, parallel fibers conduct at a velocity of 0.3 to 0.4 m/sec, well comparable to, even if slightly less than, the velocity measured in vivo (Dow 1949; Eccles et al. 1967a; Garwicz & Andersson 1992).

#### 16. Excitatory synaptic influence of parallel fibers on Purkinje cells

Several authors (Bower & Woolston 1983; Llinás 1982; Shambes et al. 1978b) have expressed doubt about the effectiveness of the excitatory synapses between parallel fibers and Purkinje cells. Although these synapses are plentiful on electronmicrographs, their excitatory action is not apparent in experiments in which the granular layer of the cerebellar cortex is stimulated locally. The activity of Purkinje cells is increased only in a narrow region immediately overlying the site of stimulation (Bower & Woolston 1983; Shambes et al. 1978b). This was taken as an indication of the insignificant weight of the synapses on

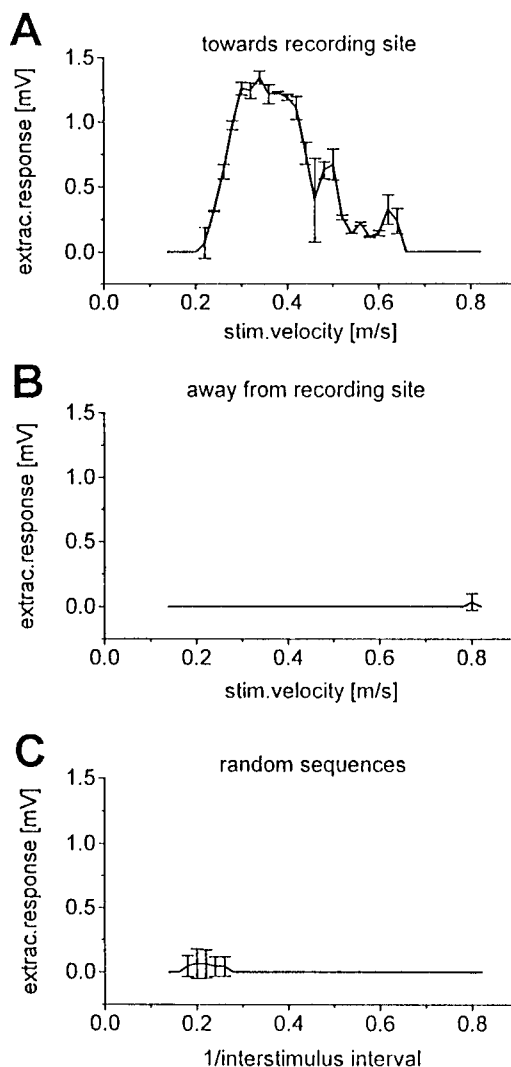

Figure 9. The amplitude of the recorded parallel fiber activity (see Fig. 8) as a function of the “velocity” of the stimulus. A: When the “movement” is toward the electrode, the signal is maximal for velocities around 0.3 to 0.4 m/sec. B: Movement away from the recording electrode does not produce any appreciable signal at any velocity, nor does (C) a random sequence of stimuli have any effect. (Modified from Heck 1993).

the horizontal branches (= the parallel fibers) of the granular cell axon, as compared to the synapses on the ascending stem of the same axon which, though fewer, were supposed to act much more strongly.

If this were the whole truth, the “tidal waves” in the molecular layer which we had postulated and even observed electrophysiologically would be functionally quite meaningless, because their cumulative strength which develops in the horizontal parallel fibers would then fail to produce postsynaptic effects. Unless, of course, the point of the whole arrangement was precisely this: to amplify the input when it is moving and to suppress static input. If this were the intended function, individually weak parallel fibers together with the provision for summation of the effects of very many of them on individual Purkinje cell would be ideal. In this case experiments with “moving” input could produce sizeable effects where static input fails completely.

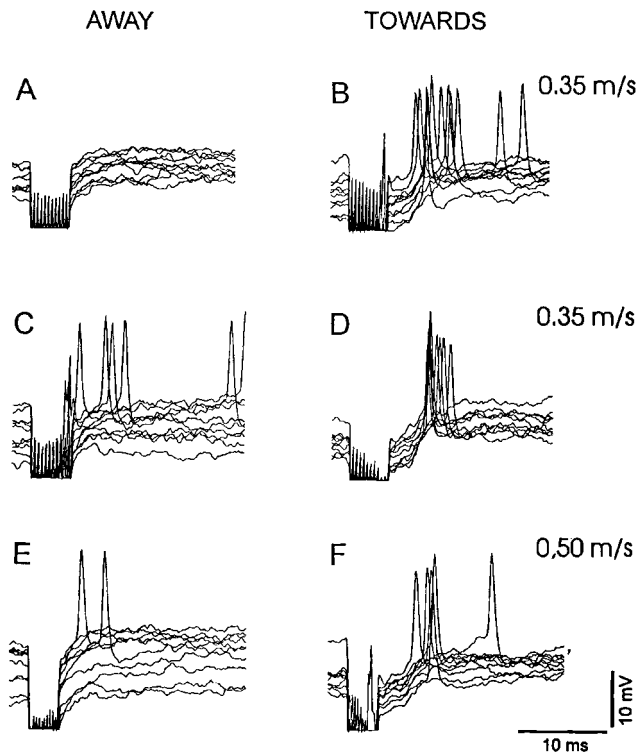

Figure 10. Intracellular recording from Purkinje cell after stimulation through a comb of electrodes as described in Figure 9. A – F: Superposition of ten trials each. Again the stimulus artifact is shown on the left. With the stimulus moving away from the electrode (A, C, E) only some spontaneous activity is observed in the Purkinje cell. With the stimulus moving toward the recording site (B, D, F), the spike activity in the Purkinje cell is increased and the spikes tend to occur at about 5 msec after the cessation of the stimulus. (From Heck 1995a) G and H show the averaged time courses of subthreshold responses (20 trials) elicited by a stimulus moving away from (G) and toward (H) the recorded Purkinje cell. (Heck 1995c)

To test this possibility, Heck (1995a; 1995c) recorded intracellularly from Purkinje cell bodies in acute slices of the (guinea pig) cerebellum, prepared in the fashion already described. The electrodes were KCl filled micropipettes with resistance greater than 70 MW. Again the stimuli were delivered through an array of 11 electrodes, in various successions imitating movement at various speeds and directions (Fig. 10). The intracellular records show increased simple spike activity in Purkinje cells precisely in the situations where in the previous experiment (Fig. 9) a large tidal wave was observed with extracellular recording. Since the extracellular wave almost certainly reflects mass action in the parallel fiber system, we may conclude, in disagreement with the above authors, that parallel-fiber-to-Purkinje-cell synapses are very effective when the input is presented to them in the right way.

### 17. Application of the tidal wave concept to a theory of cerebellar function

Having thus convinced ourselves that in the cerebellar cortex the main link between input and output (the one

involving the greatest number of synapses and neurons) is gated by certain spatiotemporal patterns in the input, we turn to the question of how this affects our view of the function of the cerebellum in general.

The main obstacle to a comprehensive view of the role of the cerebellum in its interplay with the rest of the nervous system is our insufficient knowledge of afferent and especially efferent connections. Several regions of the brain and spinal cord are known to project onto the cerebellum directly or indirectly, via mossy or climbing fibers (Brodal 1981), but the exact pattern of the projection is still a matter of controversy (Ekerot & Larson 1980; Gonzalez et al. 1993; Kassel et al. 1984; Leicht & Schmidt 1977; Leicht et al. 1977; Oscarsson 1976; 1979; Woolston et al. 1981). Yet more obscure are the ways in which the output of the cerebellum is inserted into the mainstream of motor control, to which it supposedly contributes. These are open questions that limit the poignancy of any functional scheme we may propose. To be on the safe side, we shall start our speculations from the facts that we consider certain, namely, from the structure of the cerebellar cortex interpreted in the way we have just shown. We will then tentatively apply our scheme to the functional context in which the cerebellum is usually seen, that is, control of movement in concert with the cerebral cortex.

The concept of a beam of parallel fibers, first introduced by Eccles et al. (1967a) is central to our scheme. We may define it as a laterolateral strip of cerebellar cortex reaching from the right to the left margin of the cerebellum (in the anterior and central part of the cerebellar map; Figs. 1 and 2) or from the lateral margin to the medial margin in the paired tail-like extensions, or from the right to the left margin of the posterior vermis. Note that in most cases, in larger animals at least, a beam of parallel fibers is longer (in the x direction) than the individual parallel fibers. The width of the beam could be defined as the width of the dendritic ramification of individual Purkinje cells (in the y direction), for that is the width that includes all the parallel fibers which may converge onto one and the same neuron. Another way of defining the extension of the beam in the y direction is based on the geometry of basket and stellate cell axons. These inhibit Purkinje cells in the front and in the back (in the +y and -y direction) of the beam in which their cell bodies are located, leaving a strip of uninhibited cells in between. The width of this strip could be taken as the width of the parallel fiber beam. The distribution of terminal ramifications of basket cell axons (Bishop 1993) suggests a beam width of about 0.1 mm. If the ramification of Purkinje cell dendrites is the criterion, the beam width would be around 0.3 mm.

It should be noted that individual beams are not separated from each other by unmovable anatomical barriers. There are no discontinuities in the layout of neuronal elements along the y direction (nor in the x direction, for that matter). Rather, we should think of the beam as a physiological entity which owes its existence to a particular situation in the input. The situation is that of input excitation reaching the beam in a certain temporal sequence.

The tidal wave set up by the input will affect not only Purkinje cells, as shown in Heck's experiments, but stel-

late and basket cells as well, since these also (and exclusively) receive their excitatory input from parallel fibers. There is an important consequence to this. Due to the geometry of the inhibitory (basket and stellate) interneurons, if a certain beam is excited by just the right input sequence, it will strongly inhibit neighboring beams in the  $+y$  and  $-y$  direction. "Lateral inhibition" as described by Ratliff (1965) is embodied in this, even if the term "lateral" is misleading in the present situation, where the inhibition hits neighboring beams in front and in the back of the beam in question. In any case, the principle of "winner takes all" will be valid among beams, with the beam most precisely matched to the input sequence suppressing activity in neighboring beams, which may be also excited by the input, but less strongly so.

In defining the beam as the anatomical module in which a tidal wave may develop, one important question remains unanswered: What is the length of the beam? Is it really the entire length of the folium, which in some parts of the cerebellum may span the entire width of the organ, or should we think of the beam as limited to the length of individual parallel fibers? There is a rationale for both interpretations. As we have seen, "moving input" recruits parallel fibers into a tidal wave of increasing amplitude, up to a maximum which is reached when the input has travelled the length of one parallel fiber (a few millimeters). So, in a sense, the phenomenon is limited to that length. On the other hand, if the input keeps moving in the same direction, the tidal wave will continue undiminished after it has reached its maximum, moving along with the input and strongly exciting the folium in its entire length.

Eventually we want to apply the tidal wave mechanism to movement physiology, and we prefer to think of beams as having the length of folia. Some of the folia of larger cerebella are at least ten centimeters long. The time it takes for a wave to travel this length at the intrinsic velocity  $v_0$  is about 200 msec. This is the duration of a rapid limb movement in a large mammal, or the duration of a syllable in human speech. It is not impossible to think of the length of a beam as providing temporal order for such motor performances. It should be kept in mind, however, that the length of the majority of folia, even in larger cerebella, is less than 10 centimeters and could be held responsible only for shorter sequences.

In order to make this idea more concrete, we must try to establish what kind of input reaches the cerebellar cortex and in what geometrical order it is presented there.

## 18. Somatotopic and other maps on the cerebellar cortex

Some of the rules that govern the projection of parts of the body onto the cerebellar surface were known to clinicians and to physiologists working with macroelectrodes (Adrian 1943; Combs 1954; Snider & Stowell 1942), long before the details of cerebellar physiology were elucidated by Eccles and his school. It was known, for example, that the cerebellum had prevalently uncrossed relations with the motor periphery, and correspondingly, crossed relations with the motor cortex. Also, the homunculus was known to be represented at least twice on the cerebellar

cortex, once in the anterior lobe, with its head pointing backward, and again in the posterior lobes (corresponding to the posterior paired extension of our scheme Figs. 1 and 2), where it is split in two separate halves, heads pointing medially on the flattened cerebellar map.

Later the projections were studied with more refined methods, separately for the climbing fiber and mossy fiber input (Ekerot & Larson 1980; Gonzalez et al. 1993; Kassel et al. 1984; Leicht & Schmidt 1977; Leicht et al. 1977; Oscarsson 1976; 1979; Robertson 1984; 1985; Robertson et al. 1982; Woolston et al. 1981). The general rules were confirmed on the whole, but the details were surprising. For one thing, the Swedish group headed by Oscarsson, concentrating on the anterior lobe of the cat cerebellum, found distinct zones, or "sagittal strips," each characterized by its special kind of climbing fiber input. These strips, about 1 mm wide and running through the entire extent of the anterior lobe in a sagittal ( $y$  in our terminology) direction confirmed earlier anatomical descriptions (Jansen & Brodal 1940; Voogd 1969) of fibers in the white substance of the cerebellum arranged in a similar manner. While most of the strips on both sides of the midline received input from the same side of the body in accordance with the old clinical experience, some had bilateral input. In some strips much finer subdivisions were described, in one case a precise somatotopic representation of the entire length of the cat along the width of a strip measuring no more than 1 mm. Also, one of the strips on each side was said to be concerned exclusively with input from the distal portions of the limbs.

This organization in a succession of sagittal strips is said to permeate the entire cerebellar system even outside the cerebellar cortex proper. Individual strips of the cortex are served by special portions of the afferent inferior olivary nucleus which provides the climbing fibers, and similarly on the efferent side each strip projects on its private region of the cerebellar nuclei (Andersson et al. 1987; Trott & Armstrong 1987a; 1987b; Voogd & Bigaré 1980).

Although the detailed mapping of the anterior lobe by Oscarsson and his group relied on climbing fiber input after electrical stimulation of individual peripheral nerves, the same group maintains that if mossy fiber input is mapped instead, a map is obtained which is not identical but very similar to the other (Ekerot & Larson 1980; Oscarsson 1976).

For the purpose of our theory, the Swedish findings provide ample food for thought. Since parallel fibers span a few millimeters on both sides of their point of origin, they obviously link several sagittal zones. Whatever function we attribute to the parallel fibers, for instance that of building up tidal waves with sequential input, the function must involve more than one sagittal zone. Take as an example the sagittal zone which receives input from the animal's paw, together with the neighboring zone which represents more proximal input. A tidal wave will arise in the parallel fibers linking the two zones if the proximal input follows (or precedes) the distal input after a time interval corresponding to the conduction delay in the fibers. The whole arrangement makes a good detector for something travelling through the limb in one direction or the other at just the right speed.

The Swedish map is detailed enough so that we can

make an appraisal of the speed at which something must travel through the animal in order to elicit a strong stimulus, that is, a tidal wave in the cerebellar cortex. For this we must know the “magnification factor” (the length of the beam that represents a certain length of the body), to use a term from visual physiology. The magnification factor varies a great deal in the different representations of the cat’s somatotopy on the anterior lobe of the cerebellum. If we accept that the length of the cat is represented on 1 mm cortex, as in the so-called b-zone of Oscarsson’s map, then a succession of stimuli must travel through the cat’s body at a speed of several hundred m/s in order to make the input move through the cortex at the velocity of 0.5 m/s, the intrinsic velocity of conduction in parallel fibers which makes tidal waves of maximal amplitude (taking the length of the cat as 400 mm, a signal must travel at a speed of 200 m/s for it to take 2 msec from head to tail, the time it takes a spike in a parallel fiber to travel 1mm).

The magnification factor is very different in the global mapping of the cat’s body on the entire anterior lobe, the mapping that was known already to the old electro-physiologists and was found later to be superimposed on the more detailed maps discovered by the Swedish group. Here a folium several centimeters in length reaches from one margin of the cortex to the other and represents, for example, the left forelimb on the left, the trunk in the middle, and the right forelimb on the right. On such a map the intrinsic speed  $v_0$  of conduction in parallel fibers corresponds to a sequence of events traversing the body at a velocity of about 10 m/sec.

Not only the magnification factor varies in the different somatotopic maps, but also the orientation of the body representation with respect to the intrinsic coordinates  $x$  and  $y$  of the cerebellar cortex. If we ask in what direction the image of the cat on the anterior lobe is traversed by the parallel fibers, the answer is different in the various representations. In the compressed image of the length of the cat in the “b-zone” the parallel fibers correspond to the long axis of the animal. If we take the part of the global representation near the midline, the parallel fibers run through the image transversally from right to left. And finally around the “d-zone,” as we have already seen, the direction of parallel fibers correspond to the direction distal-proximal in the representation, that is, vertical in the standing animal. It is as if the multiple somatotopic representations had the purpose of letting the cerebellum monitor sequences of events, or movements, in whatever direction they may run through the animal’s body (Fig. 11).

## 19. Fractured maps

Even greater surprises came from some studies (Shambes et al. 1978a; 1978b; Welker 1987; Woolston et al. 1981) of sensory projections onto the granular layer of the cerebellar cortex. Extracellular recording with microelectrodes, very likely of mossy fiber afferents (or of their synaptic partners, the granular cells), revealed hardly any trace of an orderly representation of parts of the body on connected regions of the cerebellum. When the authors scanned several folia of the lateral parts of the hemisphere in various species of animals, neighboring positions in the granular layer as a rule seemed to correspond to “receptive fields” quite far apart in the animal’s anatomy. Vice

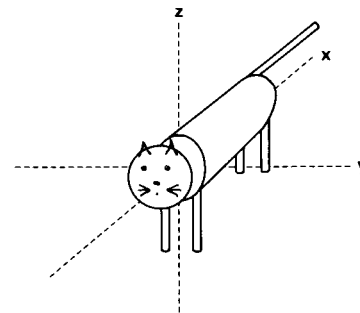
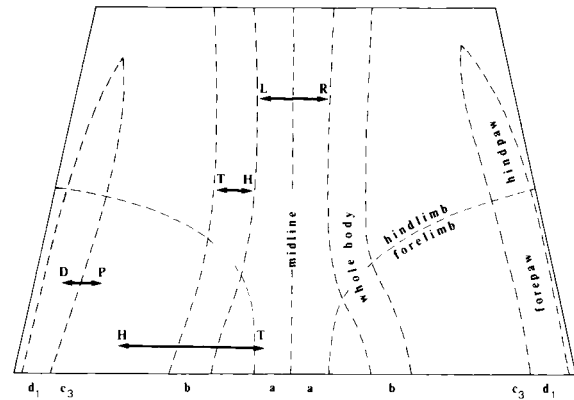

Figure 11. Simplified version of the somatotopy in the anterior lobe of the cat cerebellum as established by Oscarsson and his coworkers. The direction of the parallel fibers is horizontal on this map. It corresponds, in different somatotopic maps, to the longitudinal ( $x$ ), transversal ( $y$ ), or vertical ( $z$ ) coordinate of the cat’s body, marked on the maps as H-T (head to tail), L-R (left-right), and D-P (distal-proximal). (Data from Andersson & Eriksson 1981; Braitenberg 1983; Ekerot & Larson 1980; Oscarsson 1969; 1980.)

versa, most places of stimulation on the animal’s surface would produce responses in more than one place on the cerebellar cortex. If there was any orderly mapping to be seen, it remained confined to single patches of the mosaic-like projection, that is, to a region no larger and usually much smaller than 1 mm across. From patch to patch the progression of the corresponding places of the sensory periphery did not seem to follow any reasonable rule.

This was in contrast with the very concept of a somatotopic map which had inspired some previous descriptions, both clinical and experimental, of the relation between parts of the body and parts of the cerebellum. Whereas the physiological maps produced by Oscarsson and his group had added some detail and some local exceptions to the traditional picture without contradicting it in principle, the findings of Welker and his group were difficult to reconcile with the established prejudices.

It seems that no serious attempt was ever made to arrive at a fruitful synthesis of the contrasting opinions. Quite likely both schools highlight separate aspects of the truth, with the incompatible statements only arising where un-

due generalizations are made. The idea of sagittal strips with uniform input throughout their length, as it is implicit in Oscarsson's map (e.g., in the "b-zone"), undoubtedly was based on intra- and extrapolation from more limited observations, and deserves further experimental verification. Similarly, Welker's fractured maps were obtained by recording from the granular layer underlying the summit of the folia. This method necessarily disregards the part of the cerebellar cortex which is buried in the sulci, possibly obscuring a continuity between apparently disparate "patches." Moreover, the granular layer beneath the convex parts of the cortex is very thick and contains both granular cells and afferents belonging to a much wider region than just the summit of the folium. In the narrow core of the folia, fibers and cells are crowded together in such a way as to possibly scramble the order that may be apparent in their final destination on the cortex (see Bower & Woolston 1983 for the congruence of maps in the granular and molecular layers). Besides, the Oscarsson et al. experiments were based mainly on climbing fiber input, while Welker and his followers interpreted the signals in the granular layer as postsynaptic responses to mossy fiber input. Finally, while the Swedish group concentrated on the anterior lobe of the cat, the American researchers preferred more posterior and lateral regions which are more accessible in the smaller animals they used. (However, the most abrasive report against the orderly topography of cerebellar input by Robertson [1985] was based on climbing fiber responses in the anterior lobe, the very specialty of the Swedes.)

All in all, the two sets of data are not really comparable and it may be more correct to say that they complement, rather than contradict each other.

## 20. Some uncontroversial statements about cerebellar maps

Tentatively, we gather the following picture from the fragmentary information in the literature. Somatosensory input reaches a large part of the cerebellar surface both through climbing and mossy fibers. The two systems of afferents seem to project body maps on the cerebellum that are roughly in register. There seems to be a tendency for sagittal strips of cerebellar cortex to receive similar or perhaps even identical (via branched fibers) input. In some places it may be patches, rather than strips of similar input. Be it patches or strips, there are breaks in the representation, fragments of body maps located next to each other with no apparent common coordinates and with abrupt transitions between them. There are local maps superimposed on global maps, and in some places apparently local disorder superimposed on an otherwise fairly regular representation.

Contrary to what a previous generation of cerebellar physiologists liked to think, ("the head ganglion of the proprioceptive system") the cerebellum is fed at least as much information from the surface of the body as from the deep (muscle, tendon, and joint) senses (Andersson et al. 1987; Gellman et al. 1983; 1985; Gibson & Gellman 1987; Robertson 1984; Thach 1967; Welker 1987).

Besides input from the somatosensory periphery, relayed through the inferior olive (climbing fibers) and the pontine nuclei (mossy fibers), the cerebellum receives at least as much input from the telencephalic cortex. The

cortico-ponto-cerebellar fiber tract is massive, as Glickstein (1987) tirelessly points out, and provides mossy fibers all over the cerebellar surface. But the cortex finds its way into the cerebellum also via climbing fibers, apparently through direct cortico-olivary connections (Andersson & Eriksson 1981; Andersson & Nyquist 1983; Sasaki et al. 1977). The cerebrocerebellar projections provide good additional evidence for the reality of topographic maps on the cerebellar cortex. Where the somatotopy is well defined on the cerebral cortex, such as in the primary motor area, the projection onto the cerebellum is point to point and respects the overall somatotopy there. Other regions of the cerebral cortex, where somatotopy plays a minor part, such as the frontal and parietal areas, project more diffusely (Sasaki et al. 1977).

There is also the celebrated vestibular input to the cerebellum, perhaps the most ancient one, probably at the root of the development of the cerebellum in early vertebrate evolution. It is mainly localized in the most posterior portions of the flattened cerebellar map. At the present stage we do not intend to incorporate the vestibular system in our thinking on the function of the cerebellum in general. No matter what idea comes to mind to explain the role of the cerebellar machinery in the vestibular context, it does not seem to apply in the control of limb movements, and vice versa.

## 21. Input sequences

We are now in a position to define more precisely the sequences of events which may result in tidal waves in the molecular layer of the cerebellar cortex. If we compound everything we have learned about mossy fiber input both from the cerebral cortex and from the periphery, proceeding along a folium we may meet a succession of input points arranged in a regular somatotopic way, or fragments of somatotopic progressions abruptly set next to each other, perhaps with different scales of the representation, or a succession of input points of the cerebro-ponto-cerebellar pathway, with or without geometrical order, or a mixture of input points from ascending (spinocerebellar) and descending (corticocerebellar) pathways. The question is, what such a sequence of input points represents when they are activated in succession at the speed of conduction  $v_0$  in parallel fibers. We have already seen that in the simplest case it may represent movement of something through the body in a certain direction at a certain velocity, depending on the scale (magnification factor) of the representation. But if the maps are really fractured, the sequence represented along a folium or beam may correspond to a bizarre succession of signals from disparate parts of the body. And if the cortical input is intermingled with the spinal one, as it apparently is, a sequence along the folium or beam may represent a succession of signals in which specific motor commands from the cortex are interspersed with signals fed back from the periphery.

One more point can be made if the doctrine of the sagittal zones is seen in conjunction with the macroscopic cerebellar maps of Figures 1 and 2. The anterior lobe of the cerebellum is roughly triangular in outline. The sagittal zones which run in an anteroposterior direction through the whole extent of the anterior lobe must be converging anteriorly. If it is true that they receive the

same or very similar input throughout, we should conclude that the same (or similar) sequences are represented on successive folia with different magnification factors. This means that different folia respond to the same sequence presented at different speeds.

All of this makes sense in the light of some speculations on the cerebrocerebellar interplay which we will now propose.

## 22. Control of movement by the cerebral cortex

Although there is evidence (Georgopoulos et al. 1986; 1988; Schwartz et al. 1988;) for sets of neurons in the cortex whose activity correlates with the direction of movement, rather than with the length or force of the muscle, it is still true that the output from the motor cortex ultimately controls directly the spinal motoneurons of the *a* and *g* kind. The activity of corticospinal neurons must produce activity in the motoneurons and hence tension in individual muscles, and movement ultimately results from changes in the distribution of their activity. Rather than being programmed as such by the cortex, movement would then be a passive consequence of a changed pattern of muscular tensions. This corresponds in essence to an idea propounded by Feldman (1966; 1974a; 1974b; 1986) and by Bizzi et al. (1976; 1982a; 1982b; 1984; 1986), the equilibrium point hypothesis.

We like to subscribe to that theory without going into the arguments that have been advanced in its favor or against it. What is attractive about the idea is the conceptual simplicity that it provides. We may think of the telencephalon as of a machine which knows (= has incorporated information about) the state of the world, including the animal's body and its position in the world. It also knows the rules that govern the transitions from one state of the world to the next, and it knows the set of values associated with the states and the transitions. It will occasionally take the initiative and force a transition from one state to a more advantageous one by "rethinking" the animal's conformation or position in the world. The transition to the new state envisioned by the telencephalon automatically implies a change in the signals that reach the motor system (corticospinal neurons are part of the thinking machinery), and such changes entail actual movements.

What we don't expect the telencephalic cortex to do is to consider all the mechanical consequences which come with the transition from one conformation of the body to the next. Quite apart from friction and viscosity there is both inertia and elasticity in the structures involved, and the two together must by necessity result in oscillation. There are centrifugal and Coriolis forces which grossly affect movements of a limb with several joints. Such parasitic forces are by no means negligible: with the elbow set at a right angle, the centrifugal force acting on the forearm exceeds gravity already with a rotation in the shoulder joint as slow as 1 cycle per second (corresponding to a conductor beating *adagio*). And finally there are forces transmitted from any moving joint to all the other joints of the body by sheer mechanical coupling. The situation is so complicated that traditional methods of mathematical physics fall short of a complete analysis. For the mechanics of arm movements see Hollerbach & Flash (1982) and Hogan (1985).

It is our contention that the cerebellum takes care of the physics that is implied but not explicitly contained in the simple motor commands emanating from the cerebral cortex. The symptoms that are observed after cerebellar lesions, including clumsiness, overshoot of movements, and oscillations are not unlike what you see in a puppet when the puppeteer controls the positions of the limbs only in a global way, leaving the execution of the movement to the passive mechanical properties of the system. We claim that the intact cerebellum corrects for the parasitic forces that accompany every movement, and thus brings the actual execution closer to the smooth transition between two positions intended by the cerebral cortex.

This separation of tasks between the two great cortices, one essentially cognitive and the other mechanical must be related to the spectacular differences between the two structures that served as a starting point for our essay. We have no difficulty in interpreting the telencephalic cortex as an associative memory in which a replica of the causal structure of the outside world is built into the synaptic relations between neurons (Braitenberg & Schüz 1991). The question is now, What could the very different structure of the cerebellar cortex possibly have to do with the physics of movement?

## 23. The sequence in-sequence out mode of operation

We propose the following scheme. The functional unit is the beam of parallel fibers with the attached postsynaptic elements. It is excited by a sequence of events spelled out by the order of mossy fibers along its length. The individual events are signals from the motor cortex interspersed with signals from the periphery. The whole sequence therefore means a movement to be executed under given conditions of the motor system. The neurons of the motor cortex fire sufficiently in advance of the actual onset of movement (up to 100 msec; Evarts 1972), so that the information reaches the cerebellum early enough for it to make its own contribution to the motor command.

The output is triggered by the tidal wave which travels through the excited beam. We imagine that some of the Purkinje cells along the beam are more strongly excited by the parallel fibers than the others. What the beam passes on to the cerebellar nuclei is a sequence of signals produced by selected Purkinje cells at times specified by the moving wave of excitation.

It should be remembered that the beam is not limited to the length of parallel fiber branches. Both the input sequence to which it is tuned and consequently also the sequence of output signals it emits may have durations considerably exceeding the 10 msec limit.

The excited beam inhibits neighboring beams to prevent possible superposition of output signals from Purkinje cells.

## 24. Routes of cerebellar output

Again disregarding the small part of the cerebellum related to vestibular functions, the axons of Purkinje cells – the only fibers exiting the cerebellar cortex – terminate on cells of the cerebellar nuclei with inhibitory synapses (Ito & Yoshida 1966; Ito et al. 1964; 1970). This would be dead

output unless the cerebellar nuclei received excitation from other sources. We know that they receive collaterals from the very same fibers, mossy (Shinoda et al. 1992) and climbing (Dietrichs & Walberg 1989; van der Want et al. 1989) that bring excitation into the cerebellar cortex. What comes to mind is the idea proposed by Eccles (Eccles 1973) of the cerebellum sculpting the motor commands, that is, taking away the part of the excitation that is superfluous or damaging in the execution of a movement. This is in line with the separation of tasks that we have envisaged, the cerebral cortex (together with the spinal afferents) specifying the motor commands in a global way and the cerebellum contributing mechanical efficiency. What is interesting is that it does so by subtraction rather than addition of the results of its own computation (Braitenberg & Preissl 1992), just like the sculptor subtracts material from the block to produce the statue (what Eccles had in mind must have been one working stone or wood, rather than clay).

The further destiny of cerebellar output is not very clear. There are two main routes. The cerebellar nuclei have strong connections to the cerebral cortex via the thalamus, with excitatory synapses at both levels. Through this route the cerebellum can influence the motor command at its origin. The nuclei also have excitatory terminations at the level of the red nucleus. This being a relay station for some of the corticospinal pathways, here we have an alternative, more direct route through which the cerebellum can insert its information in the flow of motor signals between brain and spinal cord. Note that there are no inhibitory links along either route, so that no further change of sign occurs beyond the inhibition of Purkinje cells on cerebellar nuclear neurons and the idea of "sculpting" remains valid.

## 25. Sculpting motor commands for optimal performance: A model

This is not the place to go into the physics of body movement with the thoroughness it deserves, nor are we competent to do so. We shall only construct a simple model to show the principle (Fig. 12).

Figure 12a illustrates a system (the push-me-pull-you) which is characterized by an internal degree of freedom and by internal elasticity. The two equal masses  $M_1$  and  $M_2$  are connected by a spring and can be made to move without friction along a straight line by externally applied forces. If a force is applied for a certain time to  $M_1$  from the left, the center of mass of the system will move toward the right at a constant velocity  $v$ . However, the momentum of the system will be exchanged periodically between  $M_1$  and  $M_2$ , each of the two partial masses reaching the velocity  $2v$  when the other one is momentarily at rest (Fig. 12b). The internal oscillation of the system has a period  $T$  which depends on the masses and on the elasticity of the springs.

The question may be asked of how to stop the push-me-pull-you once it is set in motion. We should like not only the movement of its center of mass to stop, but also the internal oscillation. For this to happen we may deliver to  $M_2$  a pulse equal in magnitude and opposite in direction to that delivered before to  $M_1$ . This will stop the movement of the center of mass in any case, and will also stop the oscillation if it is applied at a time when  $M_1$  is without

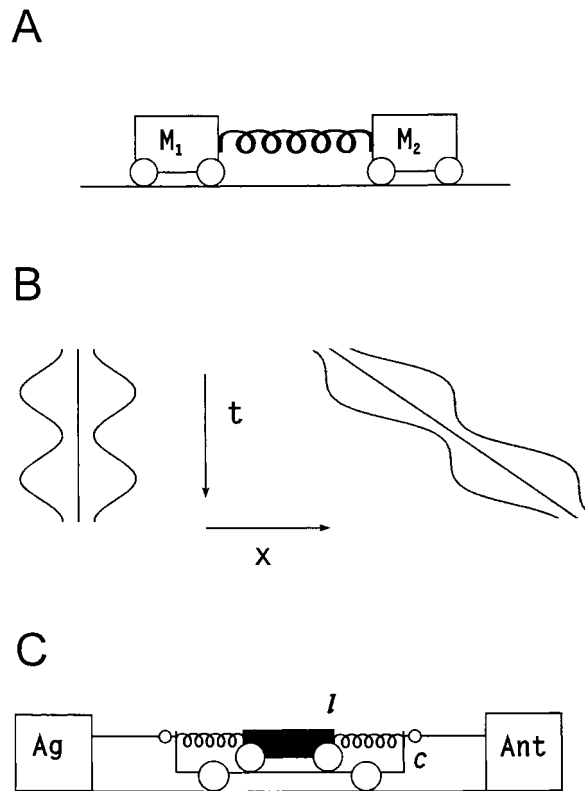

Figure 12. A: The push-me-pull-you: two masses connected by a spring. They can be made to oscillate toward and away from their common center of masses (B, left). If the system is set in motion by a push from the left, the center of mass moves with a constant velocity (oblique straight line, B right) while the masses oscillate against each other. The effect is that each of the masses in turn stops its movement when the other reaches maximal velocity. C: Two motors (Ag, Ant) pulling in opposite direction a carriage  $c$  containing a movable mass  $l$  suspended between springs. Momentum imparted to the carriage  $c$  is transmitted to the load  $l$ , which will tend to oscillate when the carriage is stopped by a momentum in the opposite direction. Stopping the carriage without residual internal oscillation requires a certain sequence of applied forces. See text.

motion and  $M_2$  carries all the momentum. This occurs at a time  $T/2$  after the system has been set in motion, and then again at time  $T + T/2$ ,  $2T + T/2$ , and so on. These times are also when the spring has come back to its resting position so that no energy, potential or kinetic, is left in the system. At all other times it is not possible to stop the motion of the system by applying a single pulse without a residual oscillation.

Consider a slight modification of this model (Fig. 12c) which brings it closer to movement physiology. Again we have two masses connected by springs, but one ( $l$ ) is contained in the other ( $c$ ) as a small carriage within a larger one. Thus the forces can be applied only to one of the masses,  $C$ , by two motors Ag and Ant pulling in opposite directions. Here again, if we want to shift the carriage  $C$  by applying pairs of opposite pulses separated by a time interval, we are limited to certain intervals (in this case multiples of  $T$ ) if we want to avoid residual oscillation.

This means, of course, that we can make the carriage C travel only multiples of an elementary distance corresponding to multiples of T at a given velocity. Otherwise the carriage will not stay put but will oscillate around the common mass center of L and C. This is a serious limitation of the principle of “bang-bang control” so dear to some movement physiologists.

There is a way around this difficulty. Suppose the carriage C is set in motion by an initial pulse delivered by Ag. It can be stopped at any time by a stronger pulse in Ant which not only counteracts the initial momentum but produces momentum in the opposite direction. This momentum is in turn annulled by a second pulse in Ag which follows the Ant-pulse after the critical time T so as to absorb the internal oscillation. With this strategy there is no limitation to the choice of delay between the initial Ag and the Ant-pulse, and therefore no restrictive condition on the distance travelled. The only condition for a complete standstill of the system is the fixed delay between the Ant-pulse and the second Ag-pulse, which does not change for movements of different amplitude.

The relation of this mechanical model to real limb movement is the following: the carriage C stands for the part that is to be moved, that is, the (stretched) arm around the shoulder. The contents of C, masses and springs, represent everything that is loosely but elastically connected to the arm, including the forearm, the hand, and all the muscles and other tissues of the arm itself. Ag and Ant are antagonistic muscle groups of the shoulder joint that produce equal and opposite forces for holding, and differential forces for movement. If a multijoint and multimuscule system such as the entire arm seems poorly represented by our simple mechanical model, think of movement of one segment only: there are always considerable masses of soft tissue elastically fastened to the moving bone.

The so-called triphasic pattern of innervation, reminiscent of the three pulse sequence that we postulated for optimal “bang-bang-bang” control in Figure 12c, is generally observed in rapid limb (Wadman et al. 1979; 1980) and even head (Hannaford & Stark 1987) movements. As we would predict from the model, the interval between the initial activation of the agonist and that of the antagonist increases with the amplitude of the movement, while the later part of the sequence, involving the antagonist and second agonist pulse, remains constant (Wadman et al. 1979). That this programming is the business of the cerebellum is a feeling widespread among physiologists (for a review, see Brooks & Thach 1981) and clinicians (Dichgans & Diener 1984; Hore et al. 1991). There are various ways in which the cerebrum and the cerebellum could cooperate. Both the agonist and the antagonist innervation may be diffusely programmed by the cerebral cortex, with the cerebellum sculpting the raw form by well-timed inhibitions. Alternatively, the cortex may trigger only the first action of the agonist leaving the rest of the sequence to the cerebellum. The available evidence leaves room for both kinds of speculation.

The role of the cerebellum in the mechanics of movement as sketched here, to our knowledge was first proposed by Nahvi & Hashemi (1985). His idea of the neuronal machinery involved, however, is different from ours.

## 26. Role of the inhibitory interneurons in the cerebellar cortex

According to our scheme, every tidal wave arising in a beam of the cerebellar cortex not only activates Purkinje cells, but also excites also a large number of inhibitory interneurons (stellate and basket cells), which in turn strongly inhibit the Purkinje cells of neighboring beams. Quite likely the sum of the inhibitory action off beam exceeds the excitation produced by the wave on the Purkinje cells along the beam. Globally, therefore, excitation of the beam could be expected to produce an increase rather than decrease of activity in the cerebellar nuclei, since more Purkinje cells are turned off than on, and consequently less inhibition reaches the nuclei. This could be at the origin of the observation that activity in nuclear neurons covaries with activity in Purkinje cells (Thach 1972). If some Purkinje cells along an excited beam are observed together with nuclear cells which receive afferents from a larger pool of Purkinje cells, one could well get that impression.

The overall effect of excitatory input to the cerebellum could be an increase of the excitatory output from cerebellar nuclei, contrary to expectations. However, on a purely speculative level we prefer to think that what counts in the output are the signals emanating from the one most strongly excited beam, with the inhibitory interneurons serving only to isolate the beam from its neighbors. In this view the cerebellum remains essentially inhibitory. Of course our view also implies that the connections between the Purkinje cells and the motor periphery are highly specific and that they are able to operate in isolation, since otherwise the effect of Purkinje cells on the beam would be drowned out by the contrary action of Purkinje cells in neighboring beams.

Our belief that the interesting input – output transformations occur between parallel fibers and Purkinje cells, with no participation of inhibitory interneurons except in their ancillary function of background suppression, rests on a theoretical prejudice. When two kinds of neurons are served by the same input fibers (e.g., parallel fibers), one having spines on its dendrites and the other not, we tend to think that the synapses on spines (e.g., on Purkinje cells) are subject to learning while the synapses on smooth dendrites (e.g., of basket cells) are unalterable by experience. For a review of the empirical basis of this prejudice see Horner (1993). We like to think that the cerebellar cortex, just like the cerebral cortex, stores information by modifying the strength of its synapses, and the parallel fiber synapses on the spines of Purkinje cells dendrites are the best candidates for that.

## 27. Two kinds of learning in the cerebellum

At this stage our theorizing will continue completely unbridled by empirical evidence, not for lack of research on plasticity in the cerebellum, but for lack of a consensus of the researchers involved.

Besides dendritic spines, “mossy fibers” such as found in various places in the nervous system (e.g., in the hippocampus) are also suggestive of learning processes. When the synapses of one long axonal segment, instead of being randomly distributed along its length, as on pyrami-



dal cell axon collaterals of the cerebral cortex (Hellwig et al. 1994) or on parallel fibers in the cerebellum (Sultan & Rotter 1994), are lumped together in a few places into gigantic synaptic conglomerations, the “mossy excrescences” or “rosettes,” we may ask what determines the position of these special synapses and suspect that it is some sort of learning process.

Tentatively, we propose the following. There is an early imprinting of the cerebellar input which decides at what places the mossy fibers establish synapses with the granular cells. Mossy fibers branch profusely especially along the direction  $y$ , less so along  $x$  (Ramón & Cajal 1911; Scheibel 1977; Sultan 1996), but their synapses seem to be distributed in a haphazard way in the granular layer. We imagine that early experience sees to it that every beam receives a different combination of mossy fiber input, perhaps one that is likely to be significant because it has occurred often in an early phase.

Later another learning process sets in which continues throughout life, the tuning of parallel fiber synapses on Purkinje cells guided by the search for the energetically most economic, mechanically simple and smooth movements. We do not know under what sensory guidance this learning takes place, but it is quite plausible that the somatosensory input to the cerebellum, which comes largely from the skin, plays a role there. If the inelegant movement of the beginner is distinguished from the elegant movement of the accomplished athlete by all the slinging and oscillating that goes on in a parasitic way in various parts of his body, the relevant input for learning may well come from receptors that signal local tension in the skin.

Together, the early imprinting and the later synaptic refinement could achieve what we take to be the role of the cerebellum in motor control. First a catalogue of sensorimotor patterns is set up in the succession of beams, then each item in the catalogue is associated with the appropriate temporal pattern of cerebellar output to optimize the motor performance. The occurrence of a particular sensorimotor pattern elicits a tidal wave in a particular beam which triggers the corresponding output sequence in real time.

## 28. Role of the climbing fibers

The climbing fibers have not played any role in our thinking about the cerebellum. Yet elimination of climbing fibers by an early destruction of their source, the inferior olivary nucleus, is said to have deleterious consequences on cerebellar function (Llinás et al. 1975; Soechting et al. 1976). The rate at which climbing fibers fire, not much more than once in a second, makes it unlikely that they are involved in the immediate business of fast motor control. They have been variously interpreted as tutors which supervise the learning process between parallel fibers and Purkinje cells (Albus 1971; Marr 1969; Ito et al. 1982), or as emergency lines which take over in exceptional situations, for example, when unforeseen obstacles get in the way of a planned movement (Gellman et al. 1985). The two ideas are not incompatible: when an acquired motor routine leads to undesirable effects, it is time to change the routine.

## 29. Epilogue

To present yet another theory of cerebellar function is to tax the patience of the specialists. If we recommend our ideas to their attention, although sketchy and likely to be changed in many ways, it is because they are anchored in the most indisputable set of data, the neuroanatomical ones. Cerebellar structure was known before and there were many speculations about it, but only recently (Heck 1993; 1995a; 1995c) did one of them turn into physiological reality. Our point is that input sequences are the key to cerebellar function, a strong point not likely to be taken back. Working from this central point out, we got onto unsafe ground in many ways – but we see the uncertainties now in a different perspective, and this may in itself be fruitful.

## Open Peer Commentary

*Commentary submitted by the qualified professional readership of this journal will be considered for publication in a later issue as Continuing Commentary on this article. Integrative overviews and syntheses are especially encouraged.*

### Microcomplexes: The basic unit of the cerebellar role in adaptive motor control

Michael A. Arbib and Jacob Spoelstra

USC Brain Project, University of Southern California, Los Angeles, CA  
90089-2520. [arbib@pollux.usc.edu](mailto:arbib@pollux.usc.edu); [spoelstr@rana.usc.edu](mailto:spoelstr@rana.usc.edu);  
[www.hbp.usc.edu/HBP](http://www.hbp.usc.edu/HBP)

**Abstract:** We offer a critique of the role of the parallel fiber beam as the unit of cerebellar computation, with the “tidal wave” as its mode of operation. Instead we see the microcomplex linking cerebellar cortex and nuclei as the unit, with parallel fibers providing the means to coordinate the effects of microcomplexes in modulating various motor pattern generators (MPGs).

Braitenberg, Heck & Sultan’s unit of cerebellar function is the anatomically attractive parallel fiber beam, but we argue that its rôle in connecting many Purkinje cells (PCs) makes it more like a bus in a computer network than a computational unit. Rhetoric aside, the “tidal wave” concept seems to offer more computational problems than it solves, because it demands an uncanny precision in the relative timing of mossy fiber inputs to a given beam. This problem is intensified because beams overlap – PC dendrites are staggered. How does the brain decide which of the overlapping beams gets the synchronized input (surely there is no evidence of synchronized input to the whole cortex or large regions thereof)? Another problem is that timing that is optimal for PCs on one side of a set of granule cells, is pessimal for cells on the other side. In any case, the tidal wave theory seems to put an undue demand on learning by systems outside the cerebellum to time inputs to cerebellar cortex. If they could learn such precise timing, why would they need the cerebellar cortex? In our own modeling, we base PC firing on integrated levels of parallel fiber (and other) firing, rather than on coincidence of spike arrivals on different parallel fibers.

Braitenberg et al. assert that “There is an *early imprinting* of the cerebellar input which decides at what places the mossy fibers establish synapses with the granular cells [to support tidal

waves].” But we suggest that granule cells, each combining about four mossy fibers from diverse sources (e.g., cortical and peripheral) and immense in their multitude, are not amenable to the temporal regimen the tidal wave theory demands. Instead (in the spirit of Marr and Albus) we see their random placement as yielding the requisite variety of nonlinear combinations of sensory and central signals to allow PCs to learn adaptive contributions to the Ecclesiastic sculpting. (As noted by Braitenberg et al., Eccles 1973 posited that cerebellar cortex sculpts the activity of the cerebellar nuclei. We further stress that the cerebellar nuclei are not MPGs, but rather modulators of MPGs.)

We agree with the importance of Oscarsson’s (1980) microzones. Noting that the Purkinje cells are inhibitory, we (Arbib et al. 1974; Boylls 1978) suggested that lowering of this inhibition could release reverberatory activity in loops joining cerebellar and reticular nuclei, and it was this activity, rather than Purkinje outflow, which served for motor control. We showed how activity in a cerebellar-nuclear complex corresponding to an Oscarsonian microzone could provide working memory for the setting of various parameters for a motor schema, and how parallel fibers could provide lateral interactions to coordinate the activity of different motor schemas. Recently, Houk and his co-workers (Houk et al. 1996, for a review) provided a partial synthesis with the ideas of Marr and Albus, combining a model of Purkinje inhibition as modulating activity in a variety of loops with a model for modification of synapses from parallel fibers to PCs.

Our more recent modeling does not dwell on the motor loops, but does stress the microcomplex (Ito 1984), a microzone plus the patch of cerebellar nucleus to which it projects, as the unit of cerebellar computation – with that computation modulating MPGs. This modulation is adaptive, thanks to adaptation of parallel fibre-PC synapses by a learning rule combining LTD and LTP. Motor timing is then improved not by explicit timing of spike sequences, but by learning to adjust MPG appropriately. For example, Schweighofer et al. (1996a) model how the cerebellum may modulate the time constant of the brainstem saccade generator to compensate for prism distortions and oculomotor nonlinearities. Braitenberg et al. note that “centrifugal and Coriolis forces . . . grossly affect movements of a limb with several joints,” and claim that “the intact cerebellum corrects for the parasitic forces.” We agree, but do not see the tidal wave as the solution. Exploring the hypothesis that the cerebellum compensates for interactions (Bastian et al. 1994) by learning part of the inverse dynamics model using feedback error learning (Kawato et al. 1987), we modeled the intermediate cerebellum (Schweighofer et al. 1996b; 1996c). The model takes into account the arm dynamics, arm muscles, significant delays in efferent and afferent pathways, and recent empirical findings.

The long parallel fibers provide microzones along a beam with shared information (cf. Thach et al. 1992). We simulated a two-link arm and showed that generating correct synergies at one joint critically depends on state information from the other joint. Motor cortex provides cerebellum with information before movement, and an early copy of ongoing commands. The cerebellum, realizing part of the inverse dynamic model, computes corrective synergies in a feedforward manner, using information on body state from the spino-cerebellar tract. Cerebellar patients show timing deficits because they are forced to rely on slow cortical feedback loops – their movements are like those seen in feedback control with long delays.

## Anatomical substrates for cerebellar computational units and cerebellar magnification factors

Jan G. Bjaalie<sup>1</sup> and Per Brodal

Department of Anatomy, Institute of Basic Medical Sciences, University of Oslo, N-0317 Oslo, Norway.

j.g.bjaalie@basalmed.uio.no; p.a.brodal@basalmed.uio.no;  
www.nesys.uio.no/

**Abstract:** We discuss anatomical data that may represent the substrate for very diverse input to a single folium, indirectly supporting the notion of a laterolateral beam spreading along the long axis of a folium. We also raise the question of whether the more linear body representation in somatosensory cortico-ponto-cerebellar pathways represent an adaptation to sequential processing of information from contiguous body parts.

Braitenberg and colleagues argue that the one-dimensional laterolateral beam (parallel fiber activity) is the computational unit in the cerebellar cortex. A major issue discussed (sect. 17, paras. 6–7) is the length of the beam. Braitenberg argues that it is plausible that beams have the length of a folium. Thus, if the input to the folium moves in one direction, the volley of activity in parallel fibers will move along with the input, possibly from one end of the folium to the other, along the long axis of the folium. Since activity in the parallel fibers travels at a constant velocity, the laterolateral extension (length) of the folium determines the duration of a sequence of information. The number of such sequences or patterns that can reach the cerebellum is determined by the anteroposterior extension.

The quantitative data provided by Sultan and Braitenberg (1993) represents novel and important information in this context. In addition, we believe that our studies of the pontocerebellar system in the cat may be of relevance to the model. With retrograde axonal tracing and computer 3-D reconstruction technique, we have shown that a single cerebellar folium (cat paraflocculus) receives input from pontocerebellar neurons distributed across a large lamella-shaped subspace in the pontine nuclei (Nikundiwe et al. 1994). This represents a morphological substrate for potentially very diverse inputs to a single folium. A possible topography within the lamella of pontocerebellar neurons projecting to a single folium could represent a substrate for sequential activation spreading along the length of the folium. We have, furthermore, demonstrated that with gradual change in target region along the long axis of the paraflocculus (from one folium to the other), there is a corresponding gradual shift of the spatial distribution of the corresponding pontocerebellar cell groups (Bjaalie et al. 1991). The latter is particularly interesting in relation to the number of sequences or patterns being processed in the anteroposterior direction, within a folium and from one folium to the other, as proposed by Braitenberg (sect. 8, para. 5). The gradual shift in location of pontocerebellar neurons could cause a gradual change in the information flow transferred by the neuronal populations. Thus, two adjacent information sequences, or beams in the terminology of Braitenberg, may deal with slightly different types of information. This of course can only be settled with extremely detailed anatomical investigations, preferably in conjunction with physiological micromapping. Experiments along these lines are now being carried out by Thompson et al. (1995) and Lyngstad et al. (1996).

Braitenberg and colleagues also discuss the relevance of somatotopic and other maps on the cerebellar cortex in the context of their theory (sect. 18). If the *sequence* from one body part to the other is crucial for cerebellar information processing, the very uneven magnification factors for various body parts found in the cerebral cortex might not be expected to be present in the cerebellar cortex. In this context, our data on body representations in cerebro-ponto-cerebellar pathways originating in somatosensory cortical areas may be relevant. Thus, we have found that in the cat (Øverby et al. 1989) and monkey (Vassbø et al. 1996), representations of distal parts of the extrem-

ities are de-emphasized in pathways from the primary somatosensory cortex to the pontine nuclei. Thus, the cerebellum receives through cortico-ponto-cerebellar pathways a more linear body representation than that contained within the cerebral cortex itself. We therefore raise the question whether this could represent an adaptation to sequential processing of information from contiguous body parts. Interestingly, a corresponding de-emphasis of projections from regions with high magnification factors occurs in visual corticopontine pathway (for references, see Brodal & Bjaalie 1992).

#### NOTE

Correspondence should be sent to Jan G. Bjaalie, Department of Anatomy, University of Oslo, P.O. Box 1105, Blindern, N-0317 Oslo, Norway.

## What do parallel fibers do?

James M. Bower

Computation and Neural Systems Program, California Institute of Technology, Pasadena, CA 91125.

[jbower@smaug.bbb.caltech.edu](mailto:jbower@smaug.bbb.caltech.edu); [www.bbb.caltech.edu/bower/ab](http://www.bbb.caltech.edu/bower/ab)

**Abstract:** Braitenberg et al.'s proposal, like most previous theories of cerebellar function (see Bower 1997, for review), is fundamentally based on the striking geometric relationship between parallel fibers and Purkinje cells. As in previous models, the current theory assumes that the activation of granule cells results in a "beam" of activated Purkinje cells, although it adds the new requirement that the granule cell layer itself have a particular spatial/temporal pattern of activation. I believe there is clear evidence that parallel fibers do not have the type of excitatory effects on Purkinje cells required by this theory.

**Beams or patches?** The first physiological evidence for the "beam hypothesis" was provided by Eccles and his colleagues who demonstrated strong Purkinje cell beam activation following direct electrical stimulation of the molecular layer (Eccles et al. 1966). The same authors subsequently showed that natural peripheral stimulation activated Purkinje cells in "patches" rather than beams (Eccles et al. 1972). Unwilling to abandon the beam hypothesis, they suggested that Purkinje cell activity required the convergence of many different parallel fiber beams, a suggestion similar to Braitenberg et al.'s in the target article.

In 1983 I published a paper that provided an alternative explanation for the Purkinje cell "patches" (Bower & Woolston 1983). Taking advantage of the discovery by Welker of a patchy organization of tactile projections to the granule cell layer (Welker 1987), we showed that only Purkinje cells overlying activated regions of the granule cell layer responded to peripheral stimulation, even when adjacent granule cell layer locations were activated in a sequence similar to the slice experiments described in the target article (see Fig. 6, Bower & Woolston 1993). We concluded that the patches of responsive Purkinje cells were not a consequence of converging beams, but instead were directly related to the patchy pattern of the underlying granule cell layer.

At present there is no evidence for beams in any published experiment in which responses of single Purkinje cells were recorded following natural peripheral stimulation. Based on anatomical as well as physiological data, we now believe that the responses we and others have recorded to natural peripheral stimuli are a result of synapses on the ascending branch of the granule cell axon (Bower 1997). We have pointed out on numerous occasions that direct electrical stimulation of the molecular layer of the type used to initially formulate the beam hypothesis orthodromically activates parallel fiber but also antidromically activates ascending branch synapses.

**How are parallel fiber and ascending branch inputs different?** Not unlike the proposal in the target article, our initial speculations concerning ascending branch effects focused on the number of synchronous inputs they would be expected to generate (Bower & Woolston 1983). However, as pointed out in the target article,

under the right circumstances, parallel fibers should also generate synchronous inputs. Recent computer simulations have suggested that cortical inhibitory neurons may play an important role in the difference between parallel fiber and ascending branch effects. Specifically, our models predict that any coordinated increase in local dendritic inhibitory input will block the ability of newly active excitatory synapses to drive somatic spiking (Jaeger et al. 1997). The circuitry of cerebellar cortex suggests that ascending branch inputs will occur before inhibitory responses are induced while the additional time delays involved in the propagation of parallel fiber volleys allows inhibition to become established. This is especially true for long propagating parallel fiber volleys where direct activation of stellate cells by the parallel fibers themselves can be expected to establish a counterbalancing "feedforward" inhibition. Closer to the origin of a parallel fiber volley, basket cells, which receive ascending branch inputs (Sultan & Bower 1996), are in an ideal position to quickly suppress Purkinje cell responses to parallel fiber inputs. This proposal is consistent with the surround distribution and timing of inhibition seen physiologically (Bower & Woolston 1983). It is important to point out that these inhibitory mechanisms would be disrupted by the slicing procedures of the *in vitro* experiments described in the target article.

**What do the parallel fibers do?** Clearly the claim that the most obvious excitatory influence of the granule cells on Purkinje cells comes from the ascending branch rather than the parallel fibers raises a rather substantial question as to the functional significance of the parallel fibers. We have previously proposed a more modulatory role for these synapses (Bower & Woolston 1983). Recent modeling studies have demonstrated that background synaptic activity similar to the type I suspect arises from a combination of parallel fiber and stellate cell inputs and has the capacity to modulate Purkinje cell responses to synchronous synaptic activation of the sort presumably generated by the ascending branches (De Schutter & Bower 1994). In this way parallel fibers may provide contextual information to evaluate activity on the ascending branch (see Bower 1997).

Experiments are currently underway to determine if the trial by trial variability seen in Purkinje cell responses to peripheral stimuli (Bower & Woolston 1983) may reflect such a modulation. If these ideas are correct, they require a substantial revision of most if not all current theories of cerebellar function including the theory presented in this target article.

## Cerebellar Purkinje units – basic functional elements of movement control

Gilbert A. Chauvet

Institute for Theoretical Biology, University of Angers, 49100 Angers, France and Biomedical Engineering, University of Southern California, Los Angeles, CA 90089-1451. [chauvet@ibt.univ-angers.fr](mailto:chauvet@ibt.univ-angers.fr)

**Abstract:** Braitenberg et al.'s target article presents the best current integration of anatomical and physiological data, and provides a qualitative description of cerebellar function in terms of the dynamics of processes based on the geometry of the cerebellar cortex. We compare the proposed model to our own quantitative model based on the concept of *Purkinje unit*.

In the target article, Braitenberg et al. offer an interesting functional interpretation of the role of the cerebellum in movement control (see, e.g., Ito 1984) in the light of available histological knowledge and their own extensive experimental work. The interpretation is based on the concepts of the "tidal wave" and the "beam of parallel fibers," the latter being considered as the "computational unit" of the cerebellar cortex. This approach has two major advantages over classical computational models and pattern associators (Tyrrell & Willshaw 1992). On one hand, it presents the best current integration of anatomical and physiological data; on the other, it provides a description of cerebellar

function in terms of the dynamics of processes based on the geometry of the cerebellar cortex. However, it certainly appears rather risky to deduce spatiotemporal properties from this descriptive approach without the support of a sound mathematical model.

We must explain, in anatomical and physiological terms, how a set of spatiotemporal patterns is actually learned and memorised for the execution of a specific task (sect. 22). The nature of these problems is essentially dynamic because we have to consider the spatiotemporal variations of patterns taking into account specific biological constraints, partly described in (sects. 1–9): (1) the hierarchical structural organisation, comprising synapses, dendritic spines, various types of cell, the association of granular cells in networks, and the association of such networks in a super-network; (2) the topological organisation, that is, the specific inter-neuronal connectivity; and (3) the “learning rules,” which reflect the properties of individual neurons at the molecular level as LTD. Each of the Purkinje cells can be considered to be associated with a *local* circuit composed of granular, basket, and stellate cells, the cerebellar cortex being a super-network of such networks, that is, a hierarchical system of units that I have called *Purkinje units*.

The theory I have been developing since 1986 is based on the concept of the *Purkinje unit*, which possesses the elementary functions of learning, memorisation, and retrieval. The Purkinje unit is a functional unit since it is the fundamental element in the learning of coordinated movements which result from the *learned* coupling between units. This is made possible by the internal dynamics of each unit and the major role played by the Golgi cell and the parallel fibers in the coupling of the units. Surprisingly, Braitenberg et al. do not think it necessary to take this into account (sect. 11). I believe that a mathematical model is indispensable because it alone could provide insight into the globally observable process through the integration of local mechanisms. The mathematical properties of the model I use correspond to the *real* properties of the system observed. Two of these properties are fundamental: *non-locality*, related to the hierarchy of the system (Chauvet 1993a), and *stability*. The latter requires a determination of the condition for the *existence* of the process of learning and retrieval. In fact, this mathematical condition, imposed on the structural characteristics of the model, contributes directly to the *definition of the unit* since the stability (existence) of the function defines the structure. In other words:

1. The definition of a Purkinje unit is geometrical and functional (Chauvet 1986).
2. The stability of the function, taking into account the internal dynamics due to the propagation time-lags inside the unit and between two units, determines the conditions for the structural definition of the unit.
3. The learning rules between units, deduced from the neuronal learning rules, govern the coordination of movement (Chauvet 1995) through excitatory or inhibitory interactions between Purkinje units. As mentioned by Braitenberg et al. (sect. 27), the hypothesis of synaptic plasticity with respect to granular cells has revealed a rich variety of learning behaviour.
4. A field theory, specifically designed to take into account the hierarchy of the system and the geometrical localisation of the neurons (Chauvet 1993b), has been used to prove that unstable units become stable when the geometry and the hierarchy of the units are considered. Furthermore, the solution of the equations reveals the existence of propagational waves.
5. The coupling between units increases the stability of the global system, in keeping with the general theory (Chauvet 1996, p. 552; Chauvet & Chauvet 1995).

Braitenberg et al.’s target article is particularly interesting because it favours the convergence of general ideas on the dynamics of the cerebellar cortex, from the qualitative as well as the quantitative points of view. It would be useful to simulate Heck’s experiments on the cerebellum and demonstrate the existence of the “tidal wave” as a solution to the equations of my field theory.

## Prediction and preparation: Anticipatory role of the cerebellum in diverse neurobehavioral functions

Eric Courchesne

Department of Neurosciences, School of Medicine, University of California, San Diego, CA 92093; and Autism and Neurodevelopment Research Laboratory, Children’s Hospital Research Center, La Jolla, CA 92037. [ecourchesne@ucsd.edu](mailto:ecourchesne@ucsd.edu)

**Abstract:** Braitenberg et al.’s view that the cerebellum contributes “mechanical efficiency” to multijoint sequences of movement is too narrow to account adequately for results from new anatomical, neurobehavioral, and neuroimaging studies. A broader view is that the cerebellum modulates attention, sensory, motor, and other neural systems in order to accomplish its prime function, which is to learn to predict and prepare for imminent information acquisition, analysis, or action.

Engaging the motor system is *not necessary* to produce cerebellar activation, according to new functional magnetic resonance imaging (fMRI) studies (Le & Hu 1996). Allen et al. (1997) have demonstrated that attention to sensory information *alone* was sufficient to activate the cerebellum (Fig. 1, left panel).

In that study, cerebellar attention activation occurred even when no motor learning was required; no motor response selection was required; no motor error detection or correction was required; no imagined motor action was required; and no guidance of motor systems was required. That study also demonstrated that attention and motor activation occurred in neuroanatomically distinct locations: motor tasks activated anterior cerebellar regions, but attention activated superior posterior lateral hemisphere regions (Fig. 1). This is the strongest evidence yet of cerebellar involvement in mental operations independent of motor operations.

This evidence also suggests that the Braitenberg et al. notion of “the cerebellum contributing mechanical efficiency” to movement is not a tenable general theory of cerebellar function. Indeed, this new fMRI evidence is contrary to the expectation of all traditional theories of the cerebellum as a motor control device. Also, Paulin (1993) points out the unsound reasoning behind the traditional belief that equates the intrinsic function of the normal cerebellum with only the motor deficits that appear following cerebellar damage. It would seem that theories of the cerebellum as strictly a motor control device – a “mechanical efficiency” device – are missing the forest for the trees.

The cerebellum, via monosynaptic or polysynaptic pathways, has physiological connections with systems involved in declarative memory, working memory, attention, arousal, affect, language, speech, homeostasis, and sensory modulation as well as motor control (Courchesne et al. 1994). fMRI studies have reported cerebellar activation during tasks involving sensory discrimination, working memory, semantic association, verbal learning and memory, affect, mental exploration, and complex cognitive problem solving (review: Akshoomoff et al. 1997). A new study shows an anatomical pathway from cerebellar dentate nuclei to prefrontal cortex area 46, which is thought to be involved in working memory, and fMRI studies showing cerebellar hemispheres and posterior vermis activated during working memory tasks (review: Akshoomoff et al. 1997). New theories (Allen et al. 1997; Bower & Kassel 1990; Coenen & Sejnowski 1996; Courchesne et al. 1994; Paulin 1993) show how the cerebellum can play a larger rôle in brain functioning than strictly motor. Nonmotor functions of the cerebellum are also shown by animal studies (reviews: Akshoomoff et al. 1997; Bernston & Schumacher 1980; Watson 1978). For example, vermis stimulation triggers self-stimulation; triggers social and emotive behavior; modulates brainstem visual, auditory, and somatosensory neural activity; and modulates hippocampal neural activity. Vermis lesions or developmental loss of Purkinje neurons disrupt “amygdala-like” behaviors: social behavior, fear responses, and responses to novelty. The size of the

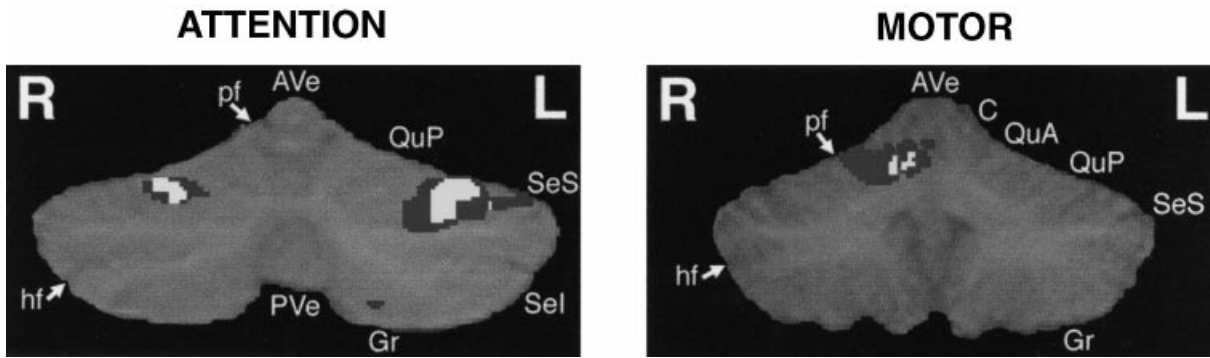

Figure 1 (Courchesne). Functional maps showing that attention alone is sufficient to activate the human cerebellum. Maps show the most common sites of activation across subjects. (Left panel) During an attention task alone (without a motor component), the most common site of activation was in the left superior posterior cerebellum. (Right panel) During the motor task alone, there was no activation in this site, but instead activation (not shown) was in the right anterior cerebellum (a site not activated during attention alone). Posterior portion of the quadrangular lobule (QuP); anterior quadrangular lobule; superior portion of the semilunar lobule (SeS); primary fissure (pf); anterior vermis (Ave); posterior vermis (PVe). (Adapted from Allen et al. 1997.)

cerebellar molecular layer in normal animals is positively correlated with attention to novelty.

The neuroimaging evidence indicates that the cerebellum is apparently composed of different regions that are influenced by and influence distinctly different neurobehavioral functions. The question that remains is, What is the nature of those multiple neurobehavioral influences?

Our hypothesis is that the cerebellum modulates activity in diverse neurobehavioral systems, in order to accomplish its prime function, which is to predict and prepare for imminent information acquisition, analysis, or action (Akshoomoff et al. 1997; Allen et al. 1997; Courchesne et al. 1994). The cerebellum accomplishes this on-line anticipatory function by first encoding (“learning”) temporally-ordered sequences of multi-dimensional information about external and internal events. Cerebellar activation will be highest during this early stage of learning (e.g., learning novel information, responses or skills, or when difficult to predict sequences must be processed). Then, whenever an analogous sequence begins to unfold, the cerebellum predicts what is about to happen, reads out the remainder of the predicted sequence, and triggers in advance changes in the neural responsiveness of whichever neural systems are expected to be needed in the next moments of time. A computational model of how the cerebellum might learn to make anticipatory predictions has been formulated (Coenen & Sejnowski 1996).

In sum, the cerebellum plays an anticipatory rôle in the learning and smooth coordination of diverse neurobehavioral functions.

#### ACKNOWLEDGMENTS

I thank Greg Allen for thoughtful comments on this article. This work was supported by NIMH grant ROI-MH36840.

### Origin of error signals during cerebellar learning of motor sequences

Michel Dufossé, Arthur Kaladjian,  
and Philippe Grandguillaume

Laboratoire Creare, UPMC, cp 23, 75 252 Paris cedex 05, France.  
michel.dufosse@aix.pacwan.net

**Abstract:** Prefrontal cerebral areas project to Purkinje cells, located in the most lateral part of the cerebellum, via mossy and climbing fibers. The latter olivary error signals reflect the attentional load of the prefrontal cortex. At the cerebral level, LTP-LTD plasticity allows these Purkinje

cells to adaptively reinforce the active pyramidal cells involved in the motor sequence.

The main differences between cytoarchitectonics of the cerebral and cerebellar cortices are nicely, clearly, and exhaustively described in Braitenberg et al.’s target article. The idea underlying this comparison is that anatomical architectures and cellular operations determine function. In other words, each structure optimally computes and learns what its cytoarchitectony allows it to do. This is implicitly postulated by the authors. Hence the statement that the cerebral cortex is essentially cognitive and the cerebellar cortex is more mechanical (sect. 22) cannot be accepted.

The absence of connections between temporal cortex and cerebellum may reflect the lack of pattern recognition ability in the cerebellum. Any “negative” result such as this one is also important for the understanding of cerebellar computation.

Two main dialogues between cerebrum and cerebellum are described by Braitenberg et al. The first dialogue concerns the timing of muscular activities, as seen, for example in the “three-burst pattern” of agonist–antagonist–agonist observed during fast arm movements. The second dialogue concerns the planning of a series of elementary movements. It involves the prefrontal cortex and two major subcortical structures, the caudate nucleus of the striatum, obviously, and also the lateral cerebellum. A sequence of actions may either be executed or simply imagined in mental training for sport exercise [See Jeannerod: “The Representing Brain” *BBS* 17(2) 1994.] or when a chess player anticipates the consequences of his next move. After a cerebellar lesion, reaction time in a task consisting of successive pointing movements no longer increases with the number of targets (Inhoff et al. 1989). This suggests that the cerebellum participates in the planning of sequential movements.

The somato-motor topography described in the target article is misleading since most studies rely on cerebellar unit activities. In fact, Purkinje cell activity mainly reflects its inputs that signal the context of the present action. These inputs are widely spread over the cerebellar cortex. Two adjacent cerebellar microzones receive similar mossy fiber inputs since each parallel fiber extends widely in the lateral direction. Functional properties of a microzone must accordingly be studied in the efferent connections or in the motor effects of microstimulations. Microzones in the rabbit’s cerebellar flocculus were clearly distinguished by the eye movements induced by cerebellar microstimulation (Dufossé et al. 1977; Ito 1984). In baboons, electromyographic changes were observed by Rispal-Padel et al. (1982) from implanted electrodes as a result of

microstimulation of interpositus and dentate nuclei. The latter study indicates that the representation of species-specific movements of the baboon has a sparse topography.

The large divergence in both cerebro-cerebellar routes and cerebello-cerebral routes strongly suggests that no prewired circuits exist. Connectivity has to be learned. We hypothesize that each microzone is defined by its afferent territory within the inferior olive. Upstream, afferent signals sent to the inferior olive are topographically organized, from peripheral to supraspinal signals, and then to cerebral activities, from motor to prefrontal. This topography corresponds roughly to the medio-lateral x-axis of the cerebellar cortex.

Olivary error signals sent to the most lateral part of the cerebellum projecting to the parvo-cellular part of the dentate nucleus result from a global level of activity in prefrontal regions. They reflect the attentional load of the prefrontal cortex. As an example, the number of corrections needed by a human subject when learning a new visuomotor transformation may be the error signal sent to lateral microzones (Roby-Brami & Burnod 1995). By contrast with the sustained activity of the Purkinje cell, which can be modulated, a pyramidal cell has much slower spontaneous activity. We consider pyramidal cell activities to indicate cerebral participation in a task; only the modulation of Purkinje cell activities indicates the cerebellar role (see also Fortier et al. 1993).

At the cerebral level, the heterosynaptic LTP-LTD plasticity (Baranyi & Feher 1978; Iriki et al. 1992) allows Purkinje cells to selectively reinforce the active pyramidal cells which are currently involved in the motor sequence. No hardware is assumed in this neural network approach. Olivary error signals result from cerebral attentional load. A two-level learning is necessary, a cerebellar LTD process with olivary teacher and a cerebral learning process which selects the active pyramidal cells and reinforces their thalamic inputs, considered as reward signals.

## Is the *tidal wave* necessary? Is it likely?

Martin Garwicz<sup>a</sup> and Gert Andersson<sup>b</sup>

<sup>a</sup>Department of Physiology and Neuroscience, Lund University; <sup>b</sup>Department of Clinical Neurophysiology, Lund University Hospital, Lund, Sweden.  
martin.garwicz@mphy.lu.se

**Abstract:** The main assumptions on which the tidal wave hypothesis rests will be questioned. First, since focal synchronous mossy fibre input is sufficient to ensure spread of activity along the parallel fibres, the tidal wave is redundant. Second, spatial *and* temporal characteristics of mossy fibre input make spatio-temporal sequences appropriate for setting up a tidal wave unlikely in the behaving animal.

**Granule cell activation and the tidal wave.** According to the hypothesis in Braitenberg et al.'s target article, cerebellar Purkinje cells in the behaving animal are activated when, and only or mainly when, a spatio-temporal sequence of mossy fibre input to granule cells along the length axis of a folium sets up a tidal wave of parallel fibre activity. However, using single shock peripheral stimulation in a whole animal preparation, Garwicz and Andersson (1992) demonstrated post-synaptic potentials in the molecular layer up to 1.5 mm outside the area of mossy fibre input to the granular layer. This activity was mediated by parallel fibres and the synaptic potentials were sufficient to strongly activate Purkinje cells. Thus, a tidal wave is not necessary to ensure spread of activity along parallel fibres.

**Maps of mossy fibre input.** A prerequisite for setting up a tidal wave of parallel fibre activity under behavioural conditions is that there exists a global map of the body represented by a topographically organized mossy fibre input along the cerebellar folia. However, there is no convincing evidence in the literature for the existence of such a map (Oscarsson 1973; 1976). Note that the depiction of somatotopy in the anterior lobe of the cat as interpreted by Braitenberg et al. (Fig. 11) is not only over-simplified,

but also represents climbing fibre input rather than mossy fibre input (for references see Andersson et al. 1987).

Most mossy fibre systems (e.g., VSCT, RSCT, and spino-reticulo-cerebellar pathways; Oscarsson 1973) have a very low degree of somatotopy and would therefore not be expected to contribute to the generation of a tidal wave. The closest approximation of a somatotopy of mossy fibre input is found within the exteroceptive component of the cuneocerebellar tract (Ekerot & Larson 1980). From medial to lateral, with an emphasis on features favouring a somatotopy, the input from this tract has the following organization in lobule V (capital letters indicate the sagittal zones). *A*: no input; *X*: forearm (weak input); *B*: no input; (*medial*) *C1*: forelimb, proximal-to-distal; (only weak input to lateral *C1*); *C2*: paw, especially ventral surface; *C3*: forelimb, proximal-to-distal-to-proximal; *D1*: no input. It is difficult to conceive a movement that would result in such a sequence of inputs.

**Sequences of mossy fibre input.** Another difficulty with the tidal wave concept is the constraint on the temporal organization of mossy fibre input. Assuming that the aim is to set up a tidal wave in the parallel fibres, there seems to be a very narrow range of velocities for a stimulus to move along the body so as to match the corresponding optimal velocity for sequentially activating granule cell along the length axis of a folium. To overcome this limitation, the authors propose that different magnification factors of the somatotopic representation in folia of different length could be used for different velocities of the same input sequence. However, given that the input to the zones changes also along the rostrocaudal dimension, this does not seem to be a realistic solution. Furthermore, if shorter folia were indeed related to higher velocities of movement, the arrangement in the anterior lobe would imply that hindlimb movements generally had higher velocities than forelimb movements. Note also that if a tidal wave was to be set up in the longest folium of the anterior lobe in the cat, the movement sequence generating the appropriate mossy fibre input would have to last less than 20 msec. Shorter folia would require even faster movements.

**In summary.** Based on the above arguments we conclude that 1. A tidal wave is not necessary for activating Purkinje cells and that 2. Its occurrence under physiological conditions seems unlikely. We hope that our criticism will contribute towards a constructive revision of the hypothesis. Generally speaking, it is debatable whether the parallel fibres are thin in order to produce time delays or simply because of economy of space. The minute distances between microzones with different output indicate that timing in motor control is not an issue governed by delays along parallel fibres. Instead, the variety of input mediated by different mossy fibre pathways suggests that the key function of the parallel fibre system is to provide a rich convergence onto Purkinje cells.

## ACKNOWLEDGMENT

M.G. was supported by the Swedish Society for Medical Research.

## Cerebellar involvement in movement timing on a variety of timescales

Jeffrey S. Grethe and Richard F. Thompson

Program for Neural, Informational, and Behavioral Sciences, University of Southern California, Los Angeles CA 90089-2520.  
grethe@neuro.usc.edu; thompson@neuro.usc.edu

**Abstract:** The cerebellum has been hypothesized to play a role in a variety of movement timing tasks that involve the processing of temporal information on a variety of timescales. Braitenberg, Heck & Sultan propose a new theory of cerebellar function that is able to account for movement timing on the order of a couple of hundred milliseconds. However, this theory does not account for the rôle the cerebellum plays in the acquisition and retention of adaptively timed discrete movements that are on the order of 200 to 1000 milliseconds, and therefore does not account for the entire temporal range of cerebellar dependent processing.

Braitenberg, Heck & Sultan propose a theory of cerebellar function based on the effectiveness of a wave of activity along a beam of parallel fibers in activating the Purkinje cells along the beam's length. This wave of activity on the parallel fibers is generated by the sequential activation of the granule cell layer by a moving stimulus in the mossy fiber–granule cell projection, with a timescale on the order of tens of milliseconds. This produces a buildup of activation in the parallel fibers that is sufficiently strong to activate Purkinje cells encountering this wave of activity.

Similar to Braitenberg et al.'s proposed theory, the classic theory concerning the functional behavior of the cerebellar cortex relies on the activation of Purkinje cells by beams of parallel fibers. This beam-like activation of Purkinje cells critically depends on the effectiveness of the parallel fiber–Purkinje cell synapses. This has been questioned by other authors (Bower & Woolston 1983; Llinás 1982) who have argued that the most effective input to the Purkinje cell arises from the synapses of ascending granule cell axons. Heck (1993; 1995a; 1995b), using a multi-electrode stimulating array, has shown that the parallel fiber–Purkinje cell synapse can play an important role in the function of the cerebellar cortex. Using an appropriate moving stimulus applied to the granule cell layer, a significant response was observed in Purkinje cells which were located along the beam in the direction of the stimulus movement. Recent research by Vranesic and colleagues (1994) further strengthens the view that the parallel fiber–Purkinje cell synapse is important in cerebellar function. Using voltage-sensitive dyes and an optical imaging system they were able to investigate the effectiveness of synaptic transmission at these parallel fiber–Purkinje cell synapses. Local electrical stimulation of rat cerebellar slices induced volleys of action potentials in the parallel fibers which in turn produced postsynaptic responses from Purkinje cells along the entire trajectory of the parallel fiber volley. The work of Braitenberg et al. and Vranesic et al. (1994) clearly demonstrate that Purkinje cells can be effectively activated in a well-organized spatio-temporal manner by beams of parallel fibers.

As Braitenberg et al. acknowledge (sect. 13, para. 1), the earlier notion that the conduction time of the parallel fibers can yield movement timing (Braitenberg 1961; Braitenberg & Atwood 1958), with a timescale on the order of 200 milliseconds, is not tenable since it can account only for delays on the order of a few milliseconds. Unlike the previous timing hypothesis, Braitenberg et al.'s current theory is able to account for movement timing with a timescale on the order of 200 milliseconds. In this theory, they place the timing process prior to the granule cells (i.e., a spatio-temporal activation of the granule cells by the mossy fiber projection): a tapped delay line notion that still begs the question of the nature and origin of the processes that yielded these tapped delay lines, which must generate precise timing to yield skilled or adaptive motor behaviors. Unlike the original timing hypothesis which relied on the propagation of a signal along the length of individual parallel fibers, Braitenberg et al. propose that their tidal wave mechanism can operate across an entire cerebellar folium. Since the length of the majority of cerebellar folia is less than 10 centimeters (sect. 17, para. 7) and the intrinsic propagation velocity of parallel fibers is on the order of 0.2 m/s to 0.5 m/s (Crépel et al. 1981; Vranesic et al. 1994), this new theory can only account for movement timing on the order of 200 milliseconds. Braitenberg et al.'s current theory of cerebellar function does not contradict the finding that the cerebellum plays a role in the temporal coordination of motor activity (Houk et al. 1990; Ito 1984) or that the cerebellum plays an important role in maintaining the proper gain and timing of the relationship between motor outputs and sensory inputs (Soechting et al. 1976; Vilis & Hore 1980) since both of these processes require temporal processing of tens of milliseconds.

However, the cerebellum also plays a critically important role in the acquisition and retention of adaptively timed discrete movements that are on the order of 200 to 1000 milliseconds. Evidence for this involvement stems from research involving classical condi-

tioning of discrete behavioral responses (e.g. eyeblink, limb flexion, etc.) (Thompson & Krupa 1994). This paradigm consists of pairing a neutral stimulus, the conditioned stimulus (CS), with an aversive stimulus, the unconditioned stimulus (US), usually separated by an inter-stimulus interval of 250 to 600 milliseconds, with the CS preceding the US. Over repeated pairings of the stimuli, an association is formed between the CS and US resulting in the performance of an adaptive conditioned response (CR) which is precisely timed to peak at the onset of the US. Current evidence from lesions, electrical stimulation, and electrophysiological recording strongly supports the hypothesis that the essential memory trace for this form of sensorimotor learning is formed and stored in the cerebellum (Thompson & Krupa 1994; Yeo 1991). Thus, reversible inactivation of the anterior interpositus nucleus and overlying cortex during training completely prevents learning, but inactivation of the output pathway from the interpositus, the superior cerebellar peduncle and its target, the red nucleus, during training does not prevent learning at all (Clark & Lavond 1993; Clark et al. 1992; Krupa & Thompson 1995; Krupa et al. 1993; 1996).

The cerebellum appears to play a vital role in the processing of temporal information on a variety of timescales from the coordination of motor activity, which necessitates temporal processing of tens of milliseconds, to the learning of adaptively timed discrete motor responses that require temporal processing on the order of hundreds of milliseconds to longer interval timing (Ivry 1993). A complete theory of cerebellar function must take into account the cerebellar contribution to the processing of information on all these temporal scales. The theory proposed by Braitenberg et al. represents an important step forward in understanding cerebellar function but does not account for the entire temporal range of cerebellar dependent phenomena.

#### ACKNOWLEDGMENT

This work supported in part by NIMH-P01MH52194.

## Patterns of organisation in the cerebellum and the control of timing

R. J. Harvey

*Neuroscience Centre and Department of Anatomy and Structural Biology, University of Otago, Dunedin, New Zealand. anrjh@otago.ac.nz*

**Abstract:** Precise timing of muscle contractions is an important prerequisite for motor control and one to which the cerebellum contributes. Braitenberg et al.'s detailed timing hypotheses relate only to a subset of the known features of the organisation of the cerebellum. However, the cerebellar architecture clearly supports the "tidal waves" that are central to the authors' proposal and such tidal waves are very likely to contribute to its functions.

The similarity of organisation of the cerebellum in different vertebrate animals whose last common ancestors lived at least 400 million years ago suggests that the particular pattern of organisation that exists is very important for its functions. Moreover, it suggests that it is doing something significant for the survival of the animals.

Braitenberg et al. bring together a large amount of mammalian anatomical and functional data that are consistent with their theory, and it is clear that the organisation allows for the type of "tidal wave" excitation on which they base much of their argument; indeed, they have produced convincing experimental evidence for it. A possible difficulty with their ideas, however, is the organisation of the cortical efferent projection (the Purkinje cell axons) to the cerebellar nuclei, which, like the afferent projections, is organised into parasagittal zones, that is, in the "y" direction in the authors' terminology and perpendicular to their "beams" of parallel fibre activation. This means that a beam will not only cross between afferent zones, but also between efferent zones, since

these zones are narrower than the length of the parallel fibres. In addition, there are differences between Purkinje cells in their possession of various antigens, which presumably have some functional correlate with the different groups arranged in narrow bands in the authors' "y" direction (e.g., Hawkes & Leclerc 1987). Moreover, there appears to be overlap of the projection of a large number of Purkinje cells within a zone onto individual nuclear cells. This makes it difficult to see how the activation of a localised group of Purkinje cells can produce a specific output from the cerebellar nuclei, which is necessary for any effect on the rest of the nervous system. The argument is unconvincing, however; there would seem little point in the beautiful organisation of the cortex unless it could lead to specific output from the nuclear neurones. On organisational grounds, a group of excited Purkinje cells, associated with depressed Purkinje cells on either side in the "y" direction *ought* to produce a significant change in nuclear cell output. We will have to await investigations of the more detailed functional relationships between the cortex and the nuclei.

Braitenberg et al.'s tidal waves depend on the granule cells being distributed throughout the length of the folium, so that their successive activation generates the waves. However, while this arrangement holds for mammals, it is not universally applicable. In many parts of the fish cerebellum (Meek 1992), the granule cells are arranged in a group at either end of the folium. This arrangement would not allow the generation of tidal waves, although it would allow the conversion of time differences between the activation of the granule cells in the two groups into position differences of the maximally activated Purkinje cells (Meek 1992). However, in the mammalian cerebellum the most powerful activation of Purkinje cells by parallel fibres would occur if a tidal wave approached it from both sides. Indeed, such converging tidal waves would be the only way in which all the parallel fibres impinging on a Purkinje cell could be simultaneously activated. However, even a single tidal wave would seem to be a major overkill, as it has been reported that a rat Purkinje cell can be made to discharge by the simultaneous activation of as few as 50 parallel fibre synapses (Barbour 1993) out of the 160,000 or so on each (Harvey & Napper 1991). (Note that the number of spines per Purkinje cell is probably considerably greater for humans and other "higher" mammals, e.g., 295,000 for the cat, since it appears that the large majority of the parallel fibres passing through the dendritic tree of each Purkinje cell contact it [Harvey & Napper 1991].) Again this seems to leave little functional importance for a great deal of the cortical organisation. However, the simultaneous activation of a large number of parallel fibre synapses leads to a powerful depolarisation, that in turn leads to activation of voltage sensitive calcium channels and gives rise to "plateau" potentials in the Purkinje cell dendrites (e.g., Campbell et al. 1983) that can lead to the discharge of a burst of action potentials by the Purkinje cell. Thus, it seems at least plausible that tidal waves or converging tidal waves may switch Purkinje cells into a different mode of operation.

For the most part, the target article (deliberately) ignores the olivo-cerebellar (i.e., climbing fibre) input to the Purkinje cells. Its importance for the operation of the cerebellum is indicated by the finding that lesions of this system produce deficits that are comparable to those that occur following lesions of the cerebellum (see sect. 28). Llinás and his co-workers (Welsh et al. 1995) have suggested that the inferior olive is very much involved in cerebellar control of movement in relation to the timing of muscular activity over periods in the 100 msec range rather than the 5–10 msec or so range that is within the conduction delay in the parallel fibres. It is possible that there may be something in both ideas, so that the cerebellum is capable of dealing with time intervals from a few msec to 100s of milliseconds?

Braitenberg et al. develop some attractive and challenging concepts, but I do not feel that they can explain more than a portion of what the cerebellum does. Even though the cerebellum is probably the best understood part of the mammalian (or even

vertebrate) central nervous system, it is galling that we still understand so little about the way it operates.

## Anatomical structure alone cannot predict function<sup>1</sup>

Dieter Jaeger<sup>a</sup> and Erik De Schutter<sup>b</sup>

<sup>a</sup>Division of Biology 216-76, California Institute of Technology, Pasadena, CA 91125; <sup>b</sup>Born-Bunge Foundation, University of Antwerp-UIA, B2610 Antwerp, Belgium.

dieter@bbb.caltech.edu; erik@bbf.uia.ac.be; bbfwww.uia.ac.be/

**Abstract:** The central hypothesis of Braitenberg et al.'s target article – that tidal waves of parallel fiber excitation precisely activate Purkinje cell spiking – is hard to reconcile with recent neurophysiological and modeling data. The assumed pattern of mossy fiber input seems unrealistic, inhibition is likely to interfere with the proposed excitatory responses, and moreover, computer simulations show that the Purkinje cell is a poor coincidence detector.

While providing an interesting framework for understanding cerebellar function, the theory proposed by Braitenberg and colleagues is limited mostly to neuroanatomical speculation. In this commentary we will show that recent physiological and modeling data cast doubt on three essential components of the theory: the pattern of mossy fiber input, the purely lateral inhibition, and the sensitivity of Purkinje cells to waves of parallel fiber input. Unless major enhancements to the theory are made, and direct experimental evidence *in vivo* is found, we find it unlikely that the cerebellum is operating according to the principle of parallel fiber tidal waves.

The authors propose that only those spatiotemporal patterns of mossy fiber input that evoke waves of parallel fiber activity are effective in stimulating Purkinje cells. The simplicity of this system may seem attractive, but if it is true most patterns of mossy fiber input would *not* change cerebellar output at all. Even if the fractured somatotopic maps of the granule cell layer (Shambes et al. 1978) were set up to generate such waves, one would be able to code at most a few input-output sequences for each beam. Moreover, it has been shown that these fractured somatotopic maps show very little plasticity (Gonzalez et al. 1993), which means that an animal would be born with a limited fixed repertoire of effective input sequences. This seems a rather inefficient way to control the complex adaptive dynamics of the motor system.

A second component of the theory is the purely excitatory response along the hypothetical narrow parallel fiber beam. Braitenberg et al. specifically dismiss the presence of inhibitory responses of Purkinje cells within this beam. Instead, inhibition is suggested to suppress activation of Purkinje cells lateral to the beam. We believe that available experimental data contradict this hypothesis. Anatomically, stellate cell axons connect to Purkinje cells in the immediate vicinity of parallel fibers activating these cells (Sultan et al. 1995), which does not indicate a spared region of pure excitation. Even early recordings looking for beams of activated Purkinje cells with direct electrical parallel fiber stimulation in primates (Bloedel et al. 1972), found predominantly inhibitory responses along the center of the activated parallel fiber beam. A similar finding was made in the anesthetized rat, when parallel fibers were activated with sensory stimulation (Bower & Woolston 1983). The slice experiments showing mainly excitatory responses of Purkinje cells to a beam of electrically activated parallel fibers (Heck 1994; Fig. 10 of target article) are less convincing in our eyes, since inhibitory responses in the slice may be largely reduced through cut inhibitory connections.

Our simulation study with a realistic computer model showed that Purkinje cells *in vivo* are likely to depend on a constant background activation of inhibitory input to show a normal spiking pattern (De Schutter & Bower 1994; Jaeger et al. 1997). The



model as well as recent experimental evidence (Clark & Häusser 1995) further shows that even single stellate cell inputs can significantly modify the spike timing of Purkinje cells. The final component of the theory is the “decoder,” that is, the Purkinje cell which is supposed to act as a coincidence detector responding mostly to waves of parallel fiber activity. Braitenberg et al.’s own experimental data, however, show that the Purkinje cell seems to be a poor decoder of wave-like parallel fiber activity. Their Figure 10B shows that for identical “ideal” inputs the latency of the Purkinje cell response varied by 7 msec and had a 20% failure rate. In fact, input movement in the “wrong” direction sometimes caused responses with similar latencies to 40% of the stimuli (Fig. 10C). With responses already so variable in the slice preparation where Purkinje cells are mostly silent, one wonders how these cells firing at rates of 40 Hz and higher *in vivo* could reliably signal the presence of a wave during actual motor behavior. These experimental results match our modeling studies which suggest that even *in vivo* Purkinje cells can be quite sensitive to fast changes in the rate of parallel fiber input, but with a large jitter of the response (De Schutter 1994) and with little sensitivity to actual coincidence of the input (unpublished results). In our view it is unlikely that the Purkinje cell is a coincidence detector, instead it performs a complex integration over time of excitatory and inhibitory input (Jaeger et al. 1997).

NOTE

1. Send correspondence to De Schutter.

### Path space integrals for modeling experimental measurements of cerebellar functioning

Endre E. Kadar,<sup>a</sup> Robert E. Shaw,<sup>b</sup> and M. T. Turvey<sup>b</sup>

<sup>a</sup>Department of Psychology, University of Portsmouth, Portsmouth, PO1 2DY, United Kingdom. [kadare@psy1.psyc.port.ac.uk](mailto:kadare@psy1.psyc.port.ac.uk); [www.sci.port.ac.uk](http://www.sci.port.ac.uk)

<sup>b</sup>Center for the Ecological Study of Perception and Action, University of Connecticut, Storrs, CT 06269. [cespal@uconnvm.uconn.edu](mailto:cespal@uconnvm.uconn.edu)

**Abstract:** A propagator for a path space integral can be used to represent the “tidal wave function” and provides a natural way to model a control signal that is temporally segmented by placement of pairs of stimulating and recording electrodes. Although care must be exercised in interpreting the resulting measurement, the technique should prove useful to experimenters who study cerebellar functioning.

#### Cerebellar signal path propagators and Huygens’s principle.

It would be experimentally useful to have a way to subdivide the entire control path solution space of the cerebellum into intervals marked by a stimulating electrode-recording electrode pair, – or by a sequence of such pairs (sect. 15). A caveat must be entertained, however. The solution to the Feynman path space integral converges on the variational calculus solution to an ordinary path integral but cannot, like it, be subdivided into independent path segments (Feynman & Hibbs 1965). Any subdivision of a Feynman path space integral into a series of individual propagator steps (formulated by Equation 4 below) does not render the step independent of the contribution made by all other possible paths in the distribution, for such is the global nature of the generalized Huygens’s principle. In spite of this qualification, there is still a way in which a control signal can be broken up into a series of propagator steps representing electrode placement. Let us consider how this might be done.

The beauty of Equation (1) in the commentary by Shaw, Kadar, and Turvey (this issue) is that it naturally integrates the effects of the three sources of inhibitory inputs that constrain the excitation to local regions, while duplicating the service performed by the authors’ tidal wave equation at every site where there is local action.

The key concern is how (without benefit of feedback corrections) the individual path integrals might select among themselves the preferred motor control sequence that satisfies the stipulated intended action (as initiated from the motor cortex). Such selection is achieved by a generalized version of Huygens’s principle built into the logic of Shaw et al.’s Equation (1) (this issue) as follows: because the path space integral takes exponential form, paths far from the preferred path have extremely low phase correlation and so destructively interfere, while those close to the intended path have extremely high phase correlation and so constructively interfere (Feynman & Hibbs 1965). This results (by the generalized Huygens’s principle) in a narrow corridor of local excitation (“beams”) which falls off quickly (along each involved parallel fiber) with increased distance from the intended path (sect. 5). In this way, the propagator,  $K(b, a)$ , controls the transverse width and longitudinal direction of the space-time development of the control signal along this cerebellar corridor. It does so by weighting each local region along each corridor of paths, with an action (energy  $\times$  time), that is a function of  $A$ , the height of the tidal wave at that location, according to the exponential ( $e^{iAxt/\alpha}$ ) in Equation (1) of Shaw, Kadar & Turvey.

**Path space integrals for experimental purposes.** It would be useful to have a form of Shaw et al.’s Equation (1) that describes what takes place at or between local regions in the cerebellum (i.e., between the folia of parallel fibers) treated as a space-time interval between two events – say, a stimulating electrode site,  $a$ , and a recording electrode site,  $b$ . The tidal wave, at the moving site  $c$ , traces out its path between two stimulus events  $a$  and  $b$  according to Equation (1) below. Such events are combined by making the integral of the product of the path segments traversed by their respective propagators:

$$K(b, a) = \int_{x_c} K(b, c)K(c, a) dx_c \tag{1}$$

Allowing the path distribution integral to be subdivided into any number of segments between inputs sites and output sites (sect. 15) yields the generalization

$$K(b, a) = \int_{x_1} \int_{x_2} \dots \int_{x_{N-1}} K(b, N-1)K(N-1, N-2) \dots K(i+1, i) \dots K(1, a) dx_1 dx_2 \dots dx_{N-1} \tag{2}$$

Alternatively (but with caveat [c] in mind), building up from arbitrarily small  $\varepsilon$ -steps, Equation (3) shows the propagator by which the tidal wave sweeps between two points separated by only an infinitesimal time interval  $\varepsilon$  (correct to the first-order in  $\varepsilon$ ). Accordingly, for the complete path:

$$K(i+1, i) = 1/k \exp \left[ \frac{i\varepsilon}{\alpha} Axt \left( \frac{x_{i+1} - x_i}{\varepsilon}, \frac{x_{i+1} + x_i}{2}, \frac{t_{i+1} + t_i}{2} \right) \right] \tag{3}$$

Intervals between successive events that subdivide a path can be integrated into a single propagator by taking the product of the successive propagators. Accordingly, for the complete path we obtain:

$$\phi[x(t)] = \lim_{\varepsilon \rightarrow 0} \prod_{i=0}^{N-1} K(i+1, i) \tag{4}$$

Given the possibility of many alternative paths taken by simultaneous tidal waves, we must sum the alternative path integrals to get the propagator for the total distribution (i.e., summed over both transverse and longitudinal directions):

$$\hat{K}(b, a) = \sum_{\substack{\text{all paths} \\ a \text{ to } b}} \phi[x(t)] \tag{5}$$

Consequently, each alternative path,  $\phi[x(t)]$ , in the distribution contributes to the resultant moving tidal wave that sculpts the control excitation at the cerebellar nuclei according to

$$\phi[x(t)] = ke^{iAxt/\alpha} \quad (6)$$

In conclusion, the present perspective on the cerebellar function, along with Shaw, Kadar, & Turvey's commentary (this issue), is proposed in the spirit of Ito's (1984) invitation to nonexperts to present new ideas, even boldly radical ones. In his view there is ample reason for encouraging innovation in this key region of neuroscience.

### Branching of cerebellar parallel fibres can assist the convergence of mossy fibre input sequences that are temporally and spatially dispersed

M. Lidiert

Sherrington School of Physiology, United Medical and Dental Schools of Guy's and St. Thomas's Hospitals, London, SE1 7EH, England. [m.lidiert@umds.ac.uk](mailto:m.lidiert@umds.ac.uk)

**Abstract:** It is suggested that bifurcation of parallel fibres in the cerebellar cortex assists the spatiotemporal convergence of temporally dispersed and asomatopic inputs to granule cells. This increases the number of combinations of inputs which can be compared for the purpose of sequence recognition.

Braitenberg et al.'s target article seeks to provide a hypothesis about parallel fibre action based on histology but fails to address what is perhaps the most striking feature of the parallel fibre: it branches to conduct action potentials in both directions along a folium. A different scheme for recognizing input sequences is presented below which makes use of this branching and of the fractured somatotopy of the granular layer.

The model presented by Braitenberg et al. requires that the responses of mossy fibres and granule cells be ordered in a fixed spatiotemporal sequence. This in turn requires that mossy fibres be fired in reliable temporal relation to a stimulus. However, over the length of an afferent pathway to the cerebellum, signals will inevitably become temporally dispersed: thus a brief stimulus such as a tap produces responses in mossy fibre terminals which vary in latency from one tap to the next (see Fig. 1A of Eccles et al. 1972). Heck's experiment (1993) used precisely timed electrical stimuli to the granular layer to generate "tidal waves" but the problem remains that such waves have not been commented upon by any author examining cerebellar responses to natural, or even electrical nerve stimuli.

Branching of parallel fibres offers an opportunity to overcome (or to use) the temporal variability of mossy fibre inputs. Figure 1 illustrates this for two fibres conducting at 0.5 m/s. The bold line shows the position of the action potential with time in a parallel fibre which bifurcates at 0 mm on the distance scale. Similar plots are shown for a second fibre branching at 1 mm distance from the first and activated at four different times relative to the first. If the second fibre is activated at exactly 2.5 msec after the first, the action potentials will be conducted to the right of the diagram so that they colocalize in space and time and may form part of the target article's tidal wave. Similarly, colocalized propagation will occur to the left only when fibre 2 is activated 2.5 msec before fibre 1. However, for any interval between  $\pm 2.5$  msec the rightward propagating action potential in the first fibre will briefly meet the leftward conducting action potential in the second. The further apart the fibres are, the greater will be the interval over which their action potentials will coincide at some point in both space and time and the greater will be the temporal variability of input that can be accommodated by the system. Thus, separating related

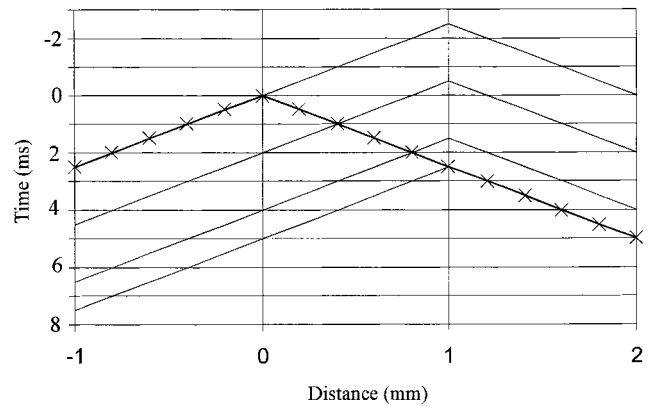

Figure 1 (Lidiert). The position of an action potential in space and time for two parallel fibres located 1 mm apart and activated at different times relative to each other.

inputs in space could assist their later convergence in both time and space via the parallel fibre system. Could this be the advantage of fractured somatotopy in the granular layer?

If we now consider three groups, each of five parallel fibres, which are activated near-synchronously (groups A, B, and C of Fig. 2) so that no tidal waves are produced we see that convergence between each pair of groups (A + B, A + C, and B + C) will occur over relatively short distances in space and time. Considerably greater scope for convergence of inputs occurs with parallel fibres of unequal conduction velocity and in this respect it should be remembered that the conduction velocity of individual parallel fibres varies with their immediate past history (Gardner-Medwin 1971; Merrill et al. 1978).

The scheme presented here appears to be better suited to sequence recognition than that of Braitenberg et al. and it accommodates more features of the parallel fibre system, namely, bifurcation of axons, variable conduction velocities, variable latencies of response to any given input and fractured somatotopy in the organization of inputs to their cells of origin in the granular layer.

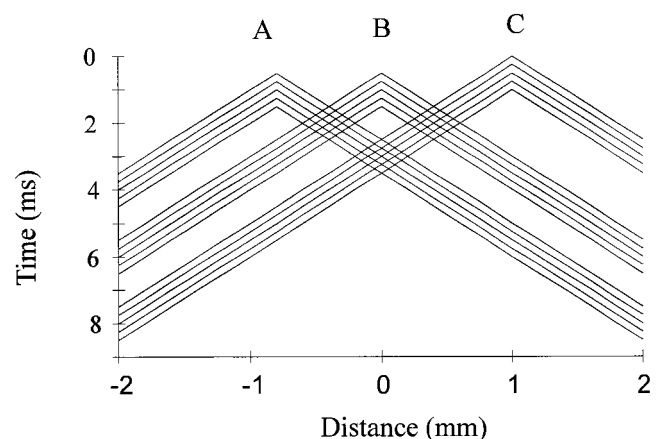

Figure 2 (Lidiert). The position of action potentials in space and time for 3 groups each of 5 parallel fibres. Pairwise convergence of input for each possible pair occurs within relatively narrow intervals of both space and time.

## Why a sequence mode if synchronization would fit the cerebellum better?

William A. MacKay

Department of Physiology, University of Toronto, Toronto, ON M5S 1A8, Canada. [william.mackay@utoronto.ca](mailto:william.mackay@utoronto.ca)

**Abstract:** The “sequence-in/sequence-out” model of cerebellar operation is mostly speculation. The same data can be interpreted in a very different way, making fewer assumptions. To wit, sets of Purkinje cells recognize a specific sensorimotor event and trigger a synchronous sensorimotor discharge.

The challenging hypothesis formulated by Braitenberg and colleagues strikes directly at fundamentals and thus offers much scope for controversy. Starting with a point of agreement, everyone would probably concur that Purkinje cells (P-cells) discharge maximally for a specific pattern of afferent input. Moreover, I have no difficulty with the notion that the optimal input set generates a “tidal wave” of parallel fiber volleys onto a given P-cell. That the tidal wave is instigated by a peripheral sequence of stimuli may be true in some instances, but I cannot accept it as a general rule without any evidence from an intact animal. None is available: this part of the hypothesis is pure assumption.

An excellent example of responsiveness to a precise spatiotemporal pattern of inputs has been demonstrated for dorsal spinocerebellar tract afferents by Bosco and Poppele (1996). Their findings, however, cannot be directly extrapolated to P-cells where a further level of integration takes place. More to the point, the Bosco and Poppele data do not truly indicate cerebellar responsiveness to a motor *sequence*, but rather to whole-limb motor parameters such as limb movement direction.

The optimal input for P-cells will generate a pair of tidal waves converging on a given set of P-cells from opposite directions in the parallel fiber beam. From the known anatomical projections and physiological characteristics of mossy fiber pathways to the granular layer, one can conclude that a specific set of stimuli will elicit the optimal response. The temporal relations and possible dynamic interactions among those stimuli, however, cannot be assumed without experimental verification. With variations in transduction/conduction time, it is just as likely that stimuli must be coincident as sequential, or any combination thereof. The only certain generality is that a group of P-cells will respond best to a dynamic event, where that event consists of a set of motor and sensory signals. The temporal relations among the signals probably varies with the P-cell group.

On the output side of the cerebellum, Braitenberg et al. have not even attempted to build a case for activation of a motor sequence. Instead they discuss P-cell “sculpting” of activity in the deep nuclei to add, presumably, “the physics of movement” missing from cerebral cortical motor signals. How this is accomplished is a mystery. There is no concrete model here, just an assembly of ideas. The missing physics in cerebellar ataxia has been identified by Bastian and colleagues (1996) as an inability to cope with dynamic interaction torques among joints. Several joint motions cannot be properly controlled simultaneously. This can be stated another way, namely that the cerebellum makes synchronization of neighboring joint actions possible. Now we can ask the question, how do you synchronize a set of motor controllers? Mechanisms of neuronal synchronization are currently a popular topic (see MacKay 1996). Synchronization of cerebral sensory neurons at gamma frequencies (30–60 Hz) appears to make use of the reticular activating system (Munk et al. 1996) and the thalamic reticular nucleus. The best way to synchronize a set of rhythmically firing neurons is first to inhibit ongoing activity so that all of them are ready to discharge when they subsequently receive a common excitatory trigger. The thalamic reticular nucleus provides this inhibitory “resetting” function for thalamocortical neurons. P-cells inhibit the neurons of the cerebellar nuclei, and that inhibition would serve to synchronize subsequent firing in a

selected set of cerebellar output neurons. In this hypothesis, the importance of timing remains, but in the form of a coordinating pulse which must be tightly coupled to a sensorimotor event detected by a particular set of P-cells.

Braitenberg et al. claim that any idea “to explain the role of the cerebellar machinery in the vestibular context, . . . does not seem to apply in the control of limb movements” (sect. 19). I disagree. Vestibular input to the cerebellar cortex is not restricted to the vestibulocerebellum: it projects to most of the vermis, for example. Furthermore, parasagittal strips of the anterior lobe (Oscarsson’s zone “b”) project to the lateral vestibular nucleus. There must be an operational theme common to all cerebellar regions. Certainly vestibular inputs define motor events as much as anything does, and will be integrated by the appropriate P-cells responding to that event. Furthermore, vestibular postural actions must be coordinated with motor volleys at other motor centers (e.g., reticulospinal nuclei, red nucleus).

Cerebellar efferents diverge: a given cerebellar locus does not project to one motor site exclusively, but usually to several. Thus sets of output neurons in the cerebellar nuclei are anatomically suited to synchronizing a number of motor sites. Moreover, the P-cell projection to the deep nuclei is similarly not restricted to a single small zone in a given nucleus. Therefore a local patch of P-cells has the potential to synchronize an extensive zone of motor sites.

In addition to multijoint coordination, cerebellar synchronizing effects would be useful in improving the coherence of a single joint motor volley to generate an adequate agonist impulse. In cases of even mild cerebellar dysfunction, ballistic wrist flexions show a decline in agonist activity and reduction of peak acceleration (Wild et al. 1996).

Finally, the synchronizing potential of climbing fiber input to the cerebellar cortex has been demonstrated by Welsh et al. (1995). They have suggested that patterns of olivocerebellar synchrony coordinate combinations of muscle contractions. This is probably overstating the case, given that the cerebellum is a few steps removed from activation of motoneurons. Precise motor synergies are ultimately determined at the spinal level. Just as an orchestral conductor gets the strings and horns sounding in unison, although he is incapable of playing either a violin or trombone, so the cerebellum ensures that the requisite parts of a movement occur together, although by itself it can neither bend an elbow nor hold a mug.

## More precise beam logic implied by cerebellar–motor coherence

Gin McCollum

R. S. Dow Neurological Sciences Institute, Good Samaritan Hospital, Portland, OR 97209. [mccollum@ohsu.edu](mailto:mccollum@ohsu.edu)

**Abstract:** Just as physics determines physically viable movements, the spatial distribution of input excitations allows the cerebellum to choose physiologically viable beams. Cerebellar–motor coherence implies that the ordering and modes of combination of cerebellar beams reflect (1) the way movement invariants are ordered and combined in movement and (2) the way physical principles are integrated in learning to move.

Braitenberg et al.’s approach to motor control raises many intriguing questions about the kind of coherence there may be between cerebellar beams and motor control sequences. The authors address these issues primarily from the point of view of cerebellar anatomy and physiology. This commentary departs from movement and input excitations.

**Viability, discreteness, physics, and physiology.** Rather than determining movement, the physics of the body affords *opportunities* for movement. The temporal if-then sequences of physics determine the physical viability of motor sequences. Similarly,

according to the target article, the anatomical arrangement of the cerebellum affords possible physiological beams: highways determining the physiological viability of movements.

Physical movements must match physiological activity in some way, although it is not necessary to be able to trace direct pathways, because there are so many ways refference can travel through the external world. The important thing is to be able to find *coherence* between appropriate logical aspects of motor control and cerebellar beams.

**Two differently-generated, both spatially-distributed, input sequences.** According to Braitenberg et al., two different types of input sequences combine in the cerebellum. Cerebral “commands” join with sensory activity to be transformed into the inhibitory output sequence.

A command such as “take a step” can be interpreted by the body in many ways: slow and plodding, on tiptoe, twirling, and so on. If a cerebral command to take a step is not maximally specific (particular muscle fibers, etc.), then the cerebral excitations reaching the cerebellum specify a whole *class of equally-acceptable step types*. Depending on the size and logic of receptive fields, sensory excitations are nonspecific in a similar but inverse way. A single sensory fiber may be excited by many different external events; a single external event may excite many different sensory fibers (Castelfranco et al. 1993; McIlwain 1986). In these two opposite ways, cerebral and sensory excitations to the cerebellum are nonspecific.

The nonspecific cerebral and sensory excitations form spatial distributions, either tight or scattered (Fig. 1). The distributions are of different types: cerebral (plaid) and sensory (shaded). Although they are spatially extended in some way, they must arrive in temporal sequence to evoke a beam.

Cerebellar beams have a different spatiotemporal form: one-dimensional and with a particular speed. This spatiotemporal change suggests a process of choosing, from among many possibilities, the physiologically and physically viable path, one beam from among many such as are drawn in Figure 1.

**Physics and contiguity versus noncontiguity.** The target article raises interesting questions about the rôle of the skin in sensing movement. It is easy to take the view that crucial sensory signals are discrete, for example footfall in locomotion. On the other hand, the image of the skin as an envelope monitoring movement and gracefulness is appealing. Choices between discrete and continuous modes arise over and over in science; the answers tend to be some combination.

Over time, physiologists have found less neighbor-preserving (more “fractured”) sensory maps. Motor performance is even more easily represented in a non-neighbor-preserving way. A muscle in one part of the body can affect just about any other part, depending upon the way force is transferred in between. That is, the pushes considered in the target article may affect many different parts, depending upon the circumstances.

Furthermore, pushes can be linear, angular, parallel to gravity,

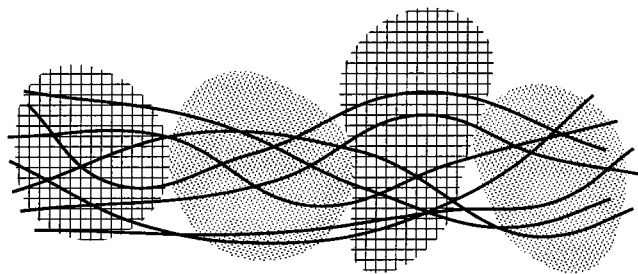

Figure 1 (McCollum). Cerebellar anatomy and physiology choose physiologically viable beams through spatial distributions of input excitations, cerebral (plaid) and sensory (shaded).

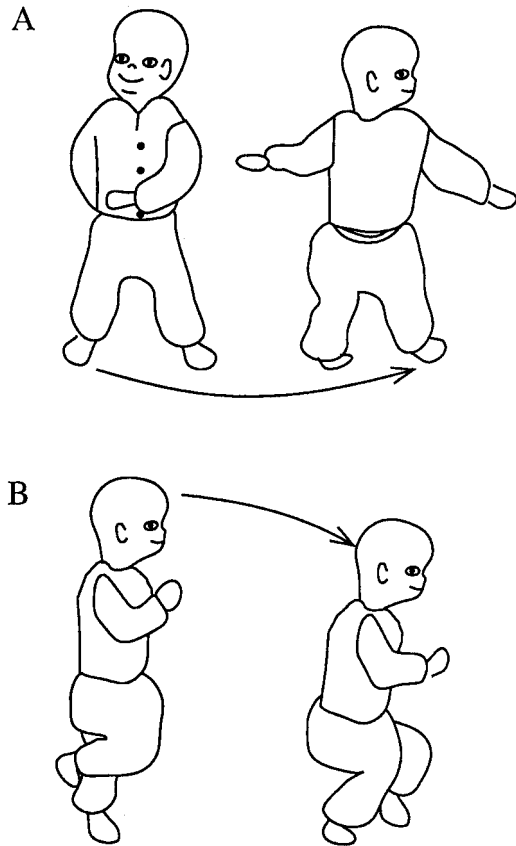

Figure 2 (McCollum). Differing forms of early walking (in the first few weeks of independent locomotion) can use different physical principles. (A) A child who progresses across the floor by twisting is using the conservation of angular momentum. (B) A child who progresses by falling for a step or more and then rising again on tiptoe is exchanging potential for kinetic energy.

or orthogonal to gravity. Movements can be conceptualized according to the physical principles governing them, for example conservation of angular momentum or exchange of potential and kinetic energy. Cerebellar-motor coherence would suggest that physical principles of body movement should be represented in some way in the ordering of cerebellar beams.

**Beams learning physics.** There is evidence that children integrate physical principles sequentially (discussed in McCollum et al. 1995). Different types of movements, using different physical principles, are physically viable for human babies learning to walk (McCollum et al. 1995). For example, to learn to control the falling movement of walking, a person integrates some version of the exchange between kinetic and potential energy in falling toward and rising away from the earth (Fig. 2A). To learn to control twisting movements in walking, a person integrates some version of the conservation of angular momentum (Fig. 2B).

If physiologically viable beams correspond to physically viable movements that obey certain laws of physics, then it would seem that beam anatomy or physiology is consolidated as a child integrates those physical principles in the first weeks of independent locomotion. This brings us back to questions about combinations of beams, because early walkers quickly add physical principles. For example, children who start in the first weeks mostly falling soon add twist. Do their beams widen or twist? Do several beams ignite at once? Cerebellar-motor coherence implies that the logical structure of beam combination corresponds to the logical structure of movement combination.

## Is the cerebellum essentially a precise pattern matching device?

Franz Mechsner and Günther Palm

Department of Neural Information Processing, University of Ulm, D-89069 Ulm, Germany. (mechsner,palm)@neuro.informatik.uni-ulm.de

**Abstract:** (1) The “timing idea” is not the only interpretation of cerebellar histology worth considering. Therefore, it is not imperative to strive for a theory of cerebellar function which gives it a prominent rôle. (2) The experiments with “moving stimuli” cannot support the tidal wave theory. (3) The notion that only “moving stimuli” can excite the cerebellar cortex is burdened with many intrinsic difficulties. (4) The common theoretical claim that the accuracy of skilled movements is due to exact pattern-matching processes in the cerebellum may be most misleading.

It was Paul Feyerabend (1976) who pointed out that scientific ideas, which in a certain period seemed unlikely or even refutable, may later experience a triumphant resurrection. It would be thrilling to see this happen to Valentino Braitenberg’s idea that the cerebellum is, in essence, a timing device. Having been put forward more than three decades ago, this idea was actually the very first functional interpretation of cerebellar histology, creating much stir at the time. However, over the years it has become obvious that Braitenberg’s model, in its original form, is certainly not the whole story.

Now Braitenberg, Heck, and Sultan have come up with a new interpretation of the cerebellar network which is based on the authors’ unchanged conviction that by taking cerebellar histology seriously one cannot but interpret the lattice-like cortical network as some sort of timing device. According to this conviction, it is *imperative* to strive for a theory of cerebellar function which gives this basic idea a prominent rôle.

It is not obvious why the timing idea should be the only interpretation of cerebellar histology worth considering. There may be many alternatives. In fact, such alternatives have been implicitly or explicitly put forward by several authors. For instance, if one wants to make sure that numerous Purkinje cells share a significant piece of input information via the same number of synapses, it seems a good idea to convey this information via parallel fibers crossing the dendritic trees of those flat cells at right angles. The fact that different Purkinje cells do not receive the individual spikes in exact synchrony, but in succession, is inherent in this arrangement and is not necessarily of special significance, especially if one assumes that the time-averaged granule cell spiking *frequency* provides the important information.

The experiments of Heck are especially designed to test the new “tidal wave” idea. However, the results cannot support the notion that the cerebellar cortex responds selectively to one single and rather exactly defined “stimulus velocity.” Braitenberg et al.’s Figure 9A shows that a whole range of stimulus velocities from 0.3 to 0.4 m/s provokes the maximal response. In a similar experiment (Heck 1993) an even broader range of maximal, and almost maximal, answers from about 0.25 to 0.45 m/s – nearly twice as much! – is observed. Thus, in striking contrast to the authors’ claim, these experiments suggest it is *almost impossible* that velocities are detected as accurately as required by the tidal wave theory.

What about the more general claim, that only “moving stimuli towards the recording site” will cause a significant measurable activity in the cerebellar cortex? Provided that this is so, and provided that these “moving stimuli” convey the only relevant information to the cerebellar cortex, how will one cope, for instance, with the well established fact that, characteristically, Purkinje cells *in vivo* are not virtually quiet, as a rule, but display resting activities of 40–70 Hz? If this resting activity is purely

“spontaneous,” that is, produced by the cell itself independently from parallel fiber input, then it is not obvious how a passing tidal wave will add any significant and detectable activity to it. If this resting activity is caused by parallel fiber activity (which is much more plausible), one might indeed try to give an explanation of the tidal wave type: provided that there is always some noise in the mossy fibers (as seems to be the case) one may assume that, simply by chance, spikes in the different fibers occur often enough in succession, giving rise to frequent tidal waves. However, if frequent tidal waves of that origin are driving the Purkinje cell resting activity, it is again hard to imagine how a “meaningful” tidal wave, provoked deliberately rather than by coincidence, could be detected. We do not see how this inevitable problem can be solved.

Actually, despite Heck’s results, we are not inclined to share Braitenberg et al.’s view that only moving stimuli can excite the cerebellar cortex. It may simply be that Heck’s few and tiny electrodes cannot provoke as much activity in the granule cell layer as the mossy fiber input usually manages to bring about *in vivo*. Of course, since we are not performing experiments of that type ourselves, we are surely not in a position to judge technical details. However, we feel that many experiments favor the conservative view that the cerebellar cortex is excited in a perfectly normal way, that is, by conveying mossy fiber spike trains which are transformed into spike trains in the granule cell axons. Take, for instance, Bower and Woolston’s (1983) experimental results which are mentioned by the authors of the target article: When stimulating the skin of circumscribed body parts of their experimental animals, Bower and Woolston found an area of Purkinje cell activation directly overlying the stimulated mossy fiber input, whereas the parallel fibers running from there never enhance the activity of Purkinje cells they cross. However, in some areas this Purkinje cell activity is *lowered*. We consider this effect to be a strong indication that parallel fibers in fact convey significant activity in this experimental arrangement. One may assume that parallel fiber activity is restricted to a constant, low level, as has been suggested by several authors (see Albus 1971; Marr 1969). Then parallel fiber activity can remain constant even in the case of an especially strongly enhanced mossy fiber activity. However, a *lowering* of activity may easily occur in those Purkinje cells to which the feeding synaptic efficiencies from the parallel fibers in question have been lowered by a learning process. There is no need to claim that only “moving stimuli” causing “tidal waves” are of relevance.

We feel uneasy with the basic notion implicit or explicit in most theories of cerebellar function, namely, that the task of the cerebellum is to produce precisely fixed, unalterable motor control patterns in response to exactly defined inputs or “contexts” (see Albus 1971; Houk 1987; Marr 1969). Such a functional principle does not fit with our intuition about skilled movements, which are not at all unalterable and robot-like. For instance, a proficient basketball player is able to perform masterfully a complex movement he has never executed before. Of course, one can claim that skilled movements are somehow “composed” of movements which result from exact pattern matching procedures, or one can claim – as Braitenberg et al. do – that it is not the entire movement, but only certain phases or aspects of the movement, which are controlled in a rigid and reproducible way. But can such a rigid scheme be the essence in the control of complex, fast, and accurate motions?

In our view, this adherence to rigidity and strict reproducibility in movement is misleading. In fact, we believe that this basic assumption, commonly taken for granted, is the main barrier to achieving a comprehensive, unconstrained, and convincing theory of cerebellar function (see Mechsner 1996).

## The cerebellum and timing: Lessons from mormyrids

J. Meek

Department of Anatomy and Embryology, Faculty of Medicine, University of Nijmegen, 6500 HB Nijmegen, The Netherlands. [j.meek@anat.kun.nl](mailto:j.meek@anat.kun.nl)

**Abstract:** Mormyrid teleosts have Purkinje cells with palisade dendrites, which probably represent coincidence detectors of parallel fiber activity. Their existence strongly supports the ideas of Braitenberg et al. on cerebellar function. However, the organization of mormyrid granule cells and parallel fibers suggests that a key to cerebellar function is not in interactions within one wave, but between *two opposite* tidal waves.

Braitenberg et al. present strong arguments in favor of the idea that the detection and generation of sequences must be a key to cerebellar function, and explain that this is presently the only theory fully accounting for the regular cerebellar geometry. Cerebellar geometry reaches its climax in mormyrid teleosts, which have the relatively largest cerebellum of all vertebrates (Nieuwenhuys & Nicholson 1967) and Purkinje cells with a dendritic palisade pattern. This means that the spiny dendrites of mormyrid Purkinje cells are all oriented parallel to each other, perpendicular to the cerebellar surface (Meek & Nieuwenhuys 1991; Fig. 1). Since climbing fiber input is restricted to the cell bodies and proximal dendrites in mormyrids (Meek & Nieuwenhuys 1991), palisade dendrites are a cerebellar specialization exclusively involved in the processing of parallel fiber (and related stellate cell) input. Their significance can only be explained by assuming that Purkinje cells are coincidence detectors of parallel fiber activity. In that case, mormyrid Purkinje cells would be optimally tuned for the detection of very precisely defined patterns of parallel fiber activity (Meek 1992a; Meek & Nieuwenhuys 1991). This is entirely in line with the ideas of Braitenberg et al., and consequently the presence of a palisade pattern in mormyrids strongly supports their hypothesis that the detection of synchronous or coincident parallel fiber activity is a major, if not the main function of cerebellar Purkinje cells.

In the mammalian cerebellum, synchrony or coincidence of parallel fiber activity at the level of the Purkinje cell dendritic tree can only be achieved by specific sequential mossy fiber input patterns that evoke tidal waves of parallel fiber activity. However, this is not the situation everywhere in the mormyrid cerebellum, since this structure contains configurations where granule cells are located lateral to the molecular layer not underneath the layer of Purkinje cells, giving rise to parallel fibers without any T-bifurcation (Meek 1992b; Fig. 2). The situation in the lobus transitorius (l.t.) is particularly interesting, since parallel fibers arise in this cerebellar subdivision from two populations of granule cells, located at the right and left side of the molecular layer (Fig. 2). This configuration may be considered as an optimal device to detect small time differences in the mossy fiber inputs to the left

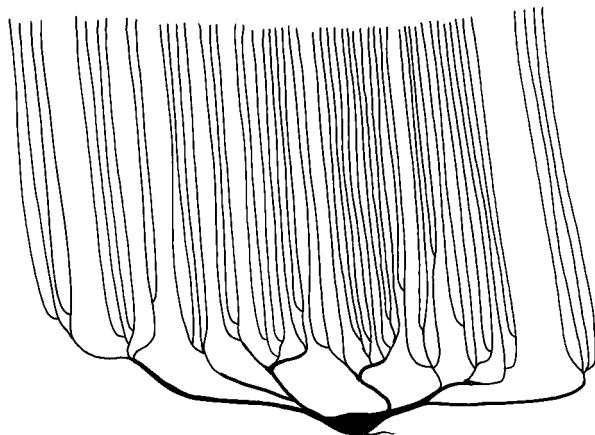

Figure 1 (Meek). Sagittal view of a mormyrid Purkinje cell.

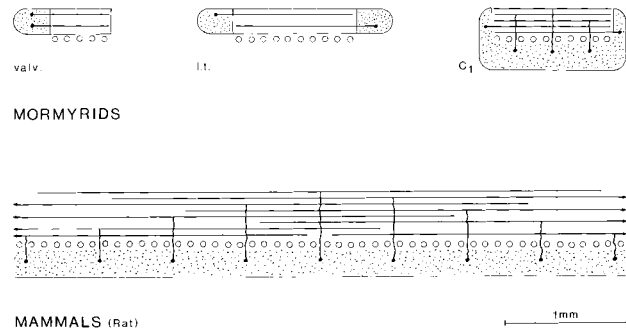

Figure 2 (Meek). Schematic transverse views of cerebellar configurations in mormyrids and mammals. Stipples and dots are granule cells, open circles are Purkinje cell bodies, and horizontal lines are parallel fibers. Valv. = valvula cerebelli; l.t. = lobus transitorius cerebelli; and C<sub>1</sub> = cerebellar lobe C<sub>1</sub>.

and right granule cell mass, and suggests that the detection of coincidence of parallel fiber activity waves conducted in *opposite directions* is a major function of Purkinje cells (Meek 1992a). In my opinion, the theory of Braitenberg et al. should be adapted at this point. It exclusively considers synchrony in the activity of parallel fibers conducting signals in the same direction, thus accounting maximally for only 50% of all parallel fiber input to any Purkinje cell (Braitenberg et al., sect. 14, para. 4). Obviously, in the mammalian cerebellum each Purkinje cell is tuned to *two* – and not one – tidal waves, one running from right to left and one in the opposite direction. Coincidence of these two tidal waves will have especially strong effects on Purkinje cells. Extending the physiological experiments of Heck to two opposite tidal waves would conceivably confirm this point. So, the detection of sequences is probably a very important feature of cerebellar function, but a full theory should consider particularly the interactions between two opposite tidal waves, and not only those within a single wave. This unravels but half of the truth and may miss the most crucial aspect of cerebellar organization.

A less important lesson from mormyrids deals with the time domain of the detection of sequences. Braitenberg et al. mention in section 13, paragraph 1, that a major problem with a timing function of the cerebellum has always been that the average length of mammalian parallel fibers allows for delays of maximally 10 msec, whereas the movements regulated by the cerebellum typically take at least 200 msec. They suggest that the complete width of the cerebellar cortex should be considered, which indeed would allow for the processing of tidal waves lasting for up to 200 msec in mammals. However, this does not hold for mormyrids or other teleosts, where the cerebellum consists of a single parasagittal zone of 0.5 to 2 mm width (Meek et al. 1992) and where all parallel fibers are as long as this total cerebellar width (Fig. 2). Such cerebella may only detect and process time differences of maximally about 5 msec (Meek 1992a), and any unifying theory should not only account for the processing and significance of time differences of 100 msec or more, but also for smaller ones in the msec range.

## Sequences of sensory predictions

R. C. Miall

University Laboratory of Physiology, Oxford, OX1 3PT, United Kingdom. [chris.miall@physiol.ox.ac.uk](mailto:chris.miall@physiol.ox.ac.uk)

**Abstract:** I argue that the rôle for the cerebellar cortex is in the generation of sensory predictions, not motor sequences. This proposal may explain the allometric relationship described in Braitenberg et al.'s target article. I also point out that the parallel beam organisation may have a nontemporal basis.

Braitenberg, Heck & Sultan suggest a single function for the whole of the cerebellum, that it generates neural sequences used for motor commands. I am also tempted by the simplicity of one function for all regions the cerebellar cortex, but I take issue with them over what that singular operation might be. I believe that the cerebellum is a sensory predictor, responsible for generating predictions about the sensory consequences of motor acts (Miall et al. 1993). Paulin (1989) and Darlot (1993) have suggested similar functions. Sensory predictions which are available in advance of the normal delayed reafferent signals can be used for control of motor systems (Miall et al. 1993) and for other functions more removed from motor control (Miall & Wolpert 1996). There is a growing body of evidence that suggests the cerebellum is more "sensory" than "motor." For example, Gao et al. (1996) have demonstrated that the dentate nucleus is highly activated during sensory discrimination tasks, whether or not the task involves movement. Diener et al. (1993) and Nawrot & Rizzo (1995) have shown perceptual deficits in cerebellar patients. Bell et al. (in press) have evidence of the generation of sensory predictions in "cerebellum-like" structures in fish. The cerebellum is also increasingly implicated in nonmotor behaviours (Leiner et al. 1993), although by itself this does not mean that its output is sensory.

I would suggest that the best predictor of a large cerebellar cortex (relative to body weight) is the ecological need for movement-related sensory analysis by each species. Braitenberg et al. are puzzled why cattle have such an extended cerebellum in the sagittal axis (sect. 9 and Fig. 2); bovines do not appear to have an expanded motor apparatus, and anthropomorphically, it is difficult to imagine a cow having a need for many more motor sequences than other quadrupeds! However, Braitenberg et al. suggest that a major input to the cerebellum is from cutaneous receptors (sect. 27); if we assume that more cerebellar cortex is required to predict the cutaneous consequences of movement, then this odd fact and the relationship given in Braitenberg et al.'s Figure 4 become more clear. In Sultan and Braitenberg (1993), they show that vermal length has a 0.54 power relationship with body weight across many species. For a spherical body, surface area scales with mass with a power of 0.66. Thus, vermal length increases with body surface, but with an exponent of less than unity: one can imagine that motor actions do not affect the whole body surface, or that a common sensory prediction can be made for a large number of cutaneous inputs. But small animals deviate more from a spherical shape than larger ones because their weight-bearing limbs can be relatively slim and long. Thus the slope of the relationship between log vermal area and log body weight should be shallower for smaller body weights, and indeed it is (Sultan & Braitenberg 1993, Fig. 19). Then in converting from vermal length to cerebellar width, and plotting against cerebellar area, one achieves the declining curve in Braitenberg et al.'s Figure 4 (see also Sultan & Braitenberg 1993, Fig. 15). I agree that the cerebellar width is likely to be related to the complexity of the inputs and duration of predictions, and am happy to believe that humans generate sensory predictions that are longer and more complex than those of other animals.

Finally, I would also point out that although their suggestions of a sequence detector system are elegant and are well borne out by Heck's electrophysiological data, there are alternative schemes that in principle would be equally effective in sequence detection and yet would look nothing like the cerebellum. For example, Abbott & Blum (1996) have shown that a simulation of overlapping neurons can both generate and predict motor sequences because of the temporal asymmetry of the rule governing LTP, but the neurons need no special geometry. Other network models for aspects of timing (Miall 1989; 1993) show that simulated neurons may not display any clear timing function individually, and thus one would not know simply from single unit recordings that they were involved in timing. So there may be other reasons for the dramatic orthogonal organisation of the cortex. One reason may be that the parallel inputs represents an efficient way to get the maximum number of different inputs onto the dendritic tree of

each Purkinje cell, while allowing neighbouring P-cells to share significant subsets of the input array.

In conclusion, I would propose that the cerebellar cortex generates sensory predictions about the outcome of movement. This may involve a timing scheme like the one proposed in the target article; it is certainly important that predictive signals have the correct temporal relationship to what they predict.

#### ACKNOWLEDGMENT

RCM is supported by the Wellcome Trust.

## Is sequence-in/sequence-out a cerebellar mode of operation in cognition too?

Marco Molinari and Laura Petrosini

*Department of Psychology, University of Rome "La Sapienza," 00185 Rome, Italy; IRCCS S. Lucia, Rome. molinari@axcasp.casur.it*

**Abstract:** This commentary reinterprets our recent data on the cerebellar contribution to different cognitive functions in light of Braitenberg and coworkers' hypothesis about the sequence-in/sequence-out cerebellar mode of operation in the motor domain. Cerebellar involvement in spatial data processing, procedural learning, verbal fluency, application of grammatical rules, and writing is dependent on sequence processing.

Braitenberg et al. clearly point out that the anatomical characteristics of cerebellar circuits are particularly apt for sequence processing, suggesting that "input sequences are the key to cerebellar function." This interesting hypothesis was tested largely in the motor domain. Recent data indicate that cerebellar function is not limited to controlling muscular activity; different cognitive functions are altered after cerebellar lesions. In particular, the lateral cerebellar hemispheres are more involved in cognition than vermal and paravermal regions. Yet this difference in function is not supported by a difference in anatomical structure. In fact, the basic cerebellar cortico-nuclear-microcomplex is identical throughout the entire cerebellum. Identical anatomical structure should imply identical function and the entire cerebellum should thus perform the same basic operation in information processing. Therefore, the sequence-in/sequence-out mode of operation should also apply to any function under cerebellar control. Once identically processed in the cerebellar microcircuitry, differences would arise as a consequence of the organisation of the cerebellar input/output connectivity with brainstem and cortical areas.

We recently reported deficits in spatial data processing (Petrosini et al. 1996), impairment in procedural learning (Molinari et al. 1995), verbal fluency deficits (Leggio et al. 1995), agrammatism (Silveri et al. 1994), or sensory dysgraphia (Silveri et al., in press) in a series of experimental and clinical studies on cerebellar cognitive functions. Can Braitenberg's hypothesis help us in understanding these apparently different deficits? It is tempting to consider that the ability "to respond specifically to certain sequences of events in the input and in turn produce sequences of signals in the output" could be the common factor linking these multifarious functions. Let us reinterpret our data according to Braitenberg's hypothesis.

Different abilities are required in spatial information processing and the different components and strategies can be separately analysed experimentally. Hemicerebellectomized rats, tested in a Morris water maze, are specifically impaired in sequential processing of the procedural components of the task (i.e., recognition of a spatial environment, putting explorative strategies into action, building a spatial map template, etc.). According to Braitenberg, this deficit could depend on difficulties in detecting/generating the appropriate behavioural sequences. The evidence that hemicerebellectomized rats exhibit ineffective behaviours, such as

circling in pool periphery, tempts us to follow Braitenberg's "idea of the cerebellum *sculpting* the motor/*behavioural* command, that is, removing the part of the excitation/inappropriate behaviour that is superfluous or damaging in the execution of a movement/behaviour."

Defective sequential processing could also be the mechanism inducing procedural learning deficits in cerebellar patients (Molinari et al. 1995). It is interesting that these defects are not confined to procedure-execution but also involve their detection and recognition. The test used in our studies required a motor response to visual stimuli presented in different positions. The subject must detect a sequence in stimulus positions so as to anticipate the next position. The lack of sequence-in/sequence-out cerebellar processing impedes sequence detection and thus affects procedural learning.

Verbal fluency (VF) is the capacity to generate lists of words according to a given rule that may be either a letter (i.e., retrieval of words beginning with the letter F) or a semantic category (i.e., retrieval of words from the semantic category of "animals"). VF is achieved by clustering words according to semantic and phonemic criteria. Cerebellar patients are particularly affected in their letter fluency and in their ability to cluster words phonemically. To obtain a phonemic cluster during a letter fluency test, two or more successive words sharing not only the same first but also the same second phoneme (i.e., fork, form) or two or more successive words which rhyme with each other (i.e., fake, flake) must be retrieved. This is achieved by sequentially coupling the last word with the new ones to select the correct sound. This procedure is not required by semantic clustering, which is based on retrieval from a storage that does not require sequential comparison between successive words. Thus verbal fluency deficit in cerebellar patients could arise from an impairment in "sequence-in-processing" at the phonological level; in this case, difficulties in detecting the last-word-sound/next-word-sound sequence.

In language production the cerebellum might also provide the correct sequences for an optimal input/output processing. Agrammatism has recently been reported following focal cerebellar lesions (Silveri et al. 1994). Putting grammatical morphemes into agreement can be achieved by sequentially comparing morphemes with the grammatical template. Again, if sequence processing is impaired, morphemes and grammatical rules cannot be effectively compared and thus the sentence construction disintegrates.

In conclusion, we would like to stress that "the detection and generation of sequences as a key to cerebellar function" could be extended to planning and controlling sequences of inhibition and activation of functional modules. In this case slightly modifying Braitenberg et al.'s own words, the

"sequences of mossy fiber activation . . . are a combination of [activity] relayed to the cerebellum by the [cortical areas devoted to planning] and information about ongoing [behaviour] reaching the cerebellum from [cortical areas devoted to internal/external environment analysis.] The output elicited by the specific sequence . . . may well be a succession of well timed inhibitory volleys "sculpting" the [behaviour] sequences so as to adapt them to the complicated requirements of [the environment we live in]."

## Learning tidal waves versus learning sensorimotor mappings

P. Morasso and V. Sanguinetti

Department of Informatics, Systems and Telecommunications (DIST),  
University of Genova, Genoa, Italy.  
morasso@dist.unige.it; www.paboratorium.dist.unige.it

**Abstract:** The sequence-in/sequence-out cerebellar machinery is considered from the computational point of view. We outline a learning framework which discriminates short-term from long-term learning and is able to explain single-trial adaptation to unexpected loads.

Braitenberg et al.'s question, "What sense can we make of the idea of the cerebellum critically tuned to the speed at which certain sequences occur in the input?" (sect. 13) is only partially answered in section 24 ("sculpting motor commands for optimal performance"), which briefly describes a bang-bang-bang control paradigm. This is not the only possibility and we think it fails to do justice to the superb computational framework, based on the sequence-in/sequence-out mode of operation of cerebellar circuitry. Moreover, we agree completely that "the cerebellum takes care of the physics that is implied but not explicitly contained in the simple motor commands emanating from the cerebral cortex" (sect. 21) and wish to add a contribution, from the point of view of a computational theory of motor control (Morasso & Sanguinetti 1997). The starting point is a rejection of the idea that motor commands are generally discontinuous and structured in a pulse-step fashion. The origin of motor smoothness is a vexing question in the motor control field. We argue that smoothness must already be inherent in the central commands for at least two reasons, an empirical and a computational one: (1) for all we know of cortical patterns they appear to be smooth and accompany movements, not simply trigger them; (2) only smooth cortical efferent patterns with a detailed timing structure can be compared with the refferent sensory patterns, and this is the essential prerequisite for learning and adaptation.

Thus, if one revisits the statement above in section 21, the "simple motor command" of cortical origin can be identified as a smooth sequence of reciprocal commands  $R(t)$  which specify the expected shortening/lengthening patterns for all the participating muscular actuators. The role of the cerebellum as a *mechanical machine* is to compensate the parasitic forces as a sort of coprocessor of the cortical *cognitive machine* which learns to modify the  $R$ -waveforms also exploiting the computational features of the muscular *compliant machinery*. A plausible computational organization which extends Braitenberg's concept can be described as follows (Fig. 1):

- (1) Sequences are the basic primitives.
- (2) The sequencing hardware operates as a *memory in time*.
- (3) Input cerebellar sequences are planned movements  $R(t)$ , consisting of expected shortening/lengthening patterns of the different muscles which read the cerebellum as collaterals of descending control commands from different precentral cortical areas.
- (4) Output cerebellar sequences are patterns of variations  $D(t)$ , to be applied to the original  $R$ -sequences, in order to compensate the time-varying internal and external disturbances.
- (5)  $R$  and  $D$ -sequences are combined into a motor command  $A$ -sequence, before reaching the spinal neuromuscular circuitry, according to a principle of minimum action (i.e., the output cerebellar signals are only inhibitory, reducing command signals which are too big rather than increasing signals which are too weak).
- (6) The input/output transformation  $R(t) \rightarrow D(t)$  is learned according to a principle of compartmentalization, that is, a movement or movement-prototype at a time, and this implies a large number of compartments, that is, a *memory in space*.

There is general agreement that the initial events of motor planning occur in the premotor cortical area, retrieving some kind of motor schema (Jeannerod et al. 1995) or memory trace of specific exemplars (Wilbert & Guay 1985). It is also known that neurons from this area give rise to descending axons as well as lateral connections to the primary motor cortex. We speculate that what is being computed is the *motor plan*, which includes the above mentioned sequence of desired shortening/lengthening patterns of the different muscles and other expected fragments of sensory patterns. The geometric coherence of this pattern, for example the fact that it is constrained to biomechanically valid configurations, can only be assured by the dynamic interaction between the *action schema* of the precentral areas and the the *body-schema* in the posterior parietal cortex (Morasso & Sanguinetti 1995). The plan is ambivalent, with a motor and a sensory



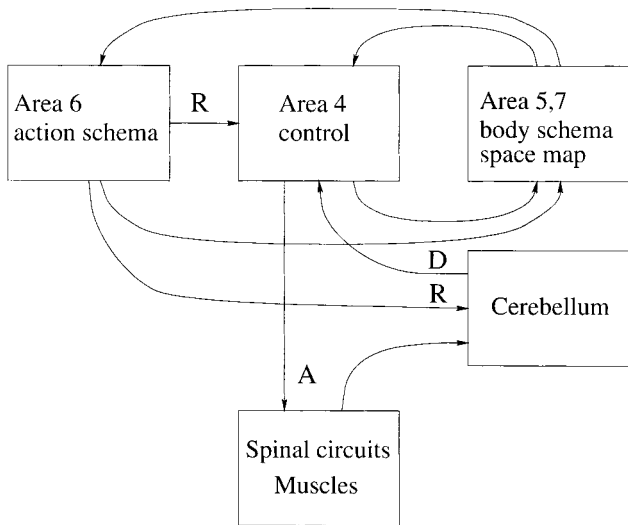

Figure 1 (Morasso & Sanguineti). Schematic block diagram of dynamic interactions in motor control. The control activity pattern  $A$  emerges from the combination of the reference plan  $R$  and the dynamic compensation  $D$ , estimated as a function of  $R$ .

nature, because the encoded variables can, at the same time, drive the peripheral motor machinery and provide the reference values for the reafferent sensory signals. In any case, the generated sequence is not a mere pulse-step command but has a precise and detailed spatio-temporal structure; it reaches the cerebellum via the pontine nuclei and the input mossy fibers, selecting by means of competition a specific *folium* or *beam of parallel fibers*. The corresponding output sequence is relayed, via the output cerebellar nuclei (dentate and interposed) and the thalamus (ventral lateral nucleus), to the motor cortex: here it can be combined with the originally planned sequence, thus producing the main cortico-spinal output control sequence. An alternative, parallel pathway goes up from the same cerebellar output nuclei to the red nucleus and then down through the rubro-spinal tract.

The sequence-in/sequence-out transformation stored in the *bundle* of cerebellar beams must be learned, according to a principle of compartmentalization or tessellation of the movement space. For simplicity, let us describe the input sequence as the following array of time functions  $\{R_i = R_i(t); i = 1, 2, \dots, N | t \leq T\}$  where  $N$  is the number of muscular actuators and  $T$  is the "time capacity" of the cerebellar delay lines. We also may use a more compact notation  $\{\tilde{r}(t) | t \leq T\}$  and we may think of these variables as desired muscle lengths, or reciprocal control variables. The corresponding output sequence will have the same dimensions and the same time-ordering:  $\{d(t) | t \leq T\}$ . The two sequences will be combined, as a result of the computational architecture described above, yielding a control activation sequence  $\{\tilde{a}(t) = \tilde{r}(t) - d(t) | t \leq T\}$ . The linear combination implies the existence of an invariant length-tension characteristics for each reflex muscle actuator which is only shifted by a changing motor command. The tessellation of the input-output transformation implies corresponding sets of prototypes. The procedure is somehow similar to the self-organized training of cortical maps but differs for many reasons and one is that "prototypes" do not correspond to an exemplar feature vector but to exemplar (input or output) sequences:

$$\{\tilde{\pi}_k^i(t) | t \leq T\} \rightarrow \{\tilde{\pi}_k^d(t) | t \leq T\}; \quad k = 1, 2, \dots, M.$$

where  $M$  is the number of beams of the cerebellar architecture. In the cortical maps, the prototype vectors correspond to the distribution of thalamo-cortical synapses for each column. In the cerebellar case, an input-sequence prototype is equivalent to the

mossy fiber/granule cell synapses and the corresponding output prototype identifies the parallel fiber/Purkinje cell synapses.

As regards the learning process, we may say in general that, different from cortical maps, it is possible to formulate a *supervised* paradigm, which uses an *error sequence* derived from the comparison between the input reference sequence and the corresponding reafferent proprioceptive sequence:

$$\{\tilde{e}(t) = \tilde{r}(t) - \tilde{p}(t) | t \leq T\}.$$

The same delay-line mechanism can obviously support the representation of the different sequences and maintain their time coherence.

The supervised or, better, self-supervised nature of the putative learning process allows something which, with the classical unsupervised learning, is not possible: a distinction between *short-term learning* and *long-term learning*. The former type of learning consists of modifying the planned  $R$ -sequence as a function of the stored  $E$ -sequence, yielding a new plan to be applied in the next trial. Long-term learning, on the contrary, is supposed to modify the sequence prototypes.<sup>1</sup> The statistical nature of Hebbian learning implies that a useful structure can only emerge when a statistically significant dataset has been experienced by the network; this is an intrinsically slow process and each adaptation step (of a specific feature vector) has no functional meaning, in the sense that it cannot be exploited immediately for any useful purpose. In the case of the cerebellar beams, on the contrary, the *error sequence* can be used immediately as a sort of short-term memory for correcting the next trial, that is, for carrying out *one-trial adaptation*.

#### NOTE

1. The iterative learning scheme has been simulated with reaching movements of the arm, using physiological levels of muscle stiffness (Morasso & Sanguineti 1997); the obtained patterns show the stability and rapid convergence of the procedure.

## The propagation of errors in sequences of cerebellar theories

Michael G. Paulin

Department of Zoology, University of Otago, Dunedin, New Zealand.  
mpaulin@otago.ac.nz

**Abstract:** An adequate cerebellar theory should explain the timing and geometry of signal propagation in the molecular layer, hence Braitenberg et al.'s explanation of how parallel fibers may act as delay lines is important. The suggestion that these delay lines may generate control signals that dampen undesirable response modes during movements is merely interesting.

Cerebellar cortex contains delay lines. There are two kinds of explanation for this. (1) They might be useful. (2) They might not. Transverse folding might be an efficient way to pack cerebellum into the cranium, and the organization of parallel fibers may facilitate this. Or this might be an efficient or easily constructed way to provide the required connectivity. Slowly-conducting beams might have evolved not because they are useful, but because they are not sufficiently harmful to have been selected against. Before trying to explain the functional significance of parallel fibers we should consider the possibility that there is none.

Cerebellar molecular layer organization is uniform across vertebrates, despite variations in associated structures that ought to provide variable constraints on cerebellar design and development. In cyclostomes and many elasmobranchs cerebellum is small and contains so few cells that mechanical and allometric constraints (Deacon 1990) are not likely to have been factors in the evolution and persistence of this pattern. Similarly, a need for high convergence from granule cells to Purkinje cells cannot explain

the thinness of parallel fibers in these species, where there is relatively low convergence and room for expanding the molecular layer and Purkinje cell dendrites to allow for thicker or even myelinated axons. In some elasmobranchs there is a space within the cranium around cerebellum. Vertical organization may have functional significance in some species but is not present in elasmobranchs, where granule cells reside in eminences near the midline (Bodznick & Boord 1986), therefore cannot be essential to cerebellar function. It would seem that signals travel slowly in beams across cerebellum because cerebellar function – whatever it is – requires this.

This is an important conclusion because it means an adequate theory of cerebellar function should include an account of timing and geometry of molecular layer signal propagation. Of many extant ideas, only the clock hypothesis does this. The original version of the hypothesis failed because of bad timing. Not simply the mismatch between the clock and the processes it was supposed to control, but also its publication just prior to the appearance of the Marr and Albus theories of cerebellum (Albus 1971; Marr 1969). The surviving common core of the Marr and Albus theories, parallel fiber–Purkinje cell synaptic plasticity related to conjunctive climbing fiber activity, is not incompatible with the clock hypothesis, but drew attention from this and other ways of thinking about cerebellum. Attempts to prove that cerebellum is a learning machine overshadowed the question *What is it learning to do?* I applaud the return of clear thinking about the dynamics of movement.

However, observing that cerebellar molecular layer contains delay lines is like opening an electronic device and exclaiming “Aha! It’s a collection of operational amplifiers!” This doesn’t tell you very much about what the device does. The authors hypothesize that parallel fiber beams allow Purkinje cells to recognize sequences. Then in section 9 they express bewilderment that their comparative data do not fit this hypothesis. I am bewildered as to why they do not then consider other possibilities. On the contrary, they elaborate the hypothesis by explaining how sequence recognition could be used in motor control. This is an interesting story, but showing that it is true will require not just creatively fitting one idea to some of the facts, but thinking critically about what ideas concerning cerebellar function are consistent with what we know about cerebellum, including that it contains delay lines. Before attempting to make sense of details it would be wise to ask more general questions.

Cerebellum appears to be necessary for generating smooth, accurate movements. This has been taken to imply that cerebellum generates or modifies signals that produce movements. Much evidence is consistent with this idea but there is no direct evidence for it. Consider this: failure in a car’s suspension system might disrupt movements because the suspension is intertwined with systems that move and steer the vehicle. But it has a clear, and clearly different, function. Analogously, cerebellum may be coupled to systems that move and steer the organism, but have an entirely distinct function (Gao et al. 1996).

Or this: breaking a car’s windscreen may disrupt its movements, not because the windscreen controls movements but because it permits certain information to reach systems that do. The cerebellum could have a role in ensuring the accuracy of central representations of state trajectories of body parts and objects in the environment (Paulin 1993; 1996). This would explain why cerebellum is essential for fast, accurate movements, but is not a motor control device and might have a direct role in certain perceptual and cognitive processes.

The cerebellum contains structures that look like delay lines. The target article explains how they might act like delay lines. This may be important for understanding how the cerebellum works. But there is no sound basis for the belief that cerebellum is a motor control organ, except in the sense that cerebellum is a reproductive organ, that is, it participates in reproductive behavior. Until we can do better than this, perhaps modellers of *how* the cerebellum

computes ought to be skeptical or at least circumspect about *what* the cerebellum computes.

## Distribution of activity in the cerebellar cortex resulting from passive limb movement

R. E. Poppele and G. Bosco

Department of Physiology, University of Minnesota, Minneapolis, MN 55455.  
dick@neuro.med.umn.edu

**Abstract:** The notion that cerebellar cortex geometry may play a unique role in its function is explored by Braitenberg et al. in the form of a new theory about the distribution of cortical activity. The theory makes specific predictions which are not verified by an experimental study of hindlimb movement in the cat.

The theory proposed in Braitenberg et al.’s target article is a recent extension of the timing hypothesis proposed originally by Braitenberg in 1961. Both are based on the assumption that cortical structure provides a unique transformation between timing and cortical location. This is a very attractive idea, but one that has proven very difficult to test experimentally.

The current theory examines a particular property of the cortical geometry, the detection a series of inputs presented in a specific spatio-temporal sequence. It predicts that the cortical circuitry can detect “waves” of movement across the body if they occur at a particular velocity. This assumes a somatotopic organization of mossy fiber inputs to the cortex, and a narrow tuning with respect to sensory inputs from small parts of the body so that movements in adjacent body segments activate primarily different mossy fiber populations.

The authors cite much of the data relevant to these assumptions but note that a macro-scale somatotopic organization of mossy fiber input has not been well tested experimentally. Some insights about that organization may be gained however from the projection patterns of spinal afferents which show considerable overlap among projections to the cortex from all spinal levels (Matsushita et al. 1984) and extensive overlap between projections from the hind- and forelimbs (Tolbert & Alinsky 1994). Thus the anatomical data do not fully support the assumption of a somatotopic organization.

Functional studies of spinocerebellar afferents employing whole-limb movements also challenge the assumption of small receptive fields. Dorsal spinocerebellar tract (DSCT) neurons were found to be broadly tuned with respect to the whole limb rather than any particular segment or joint (Bosco et al. 1996). The same point may be extended to the cerebral cortical projections to the cerebellum, since motor cortical neurons often encode parameters of whole limb or body movements (Georgopoulos et al. 1982). While it does not necessarily exclude the possibility that a complex movement may be encoded as temporal sequence of activity across cerebellar afferent neurons, such findings do raise serious questions.

Aside from the assumptions about mossy fiber organization, the proposed theory also makes predictions about the behavior of Purkinje cells (PCs) which can be tested. For example, responses to isolated movements of a single joint should be confined to one or few isolated patches of activity in the cortex.

We recently mapped the responsiveness and timing of simple spike PC activity across the spinocerebellum elicited by small, rapid rotations of the ankle joint in the anesthetized cat (Gray et al. 1993; Poppele et al. 1996). We found that except for a very medial strip, PCs distributed throughout the spinocerebellar cortex responded to these movements.

A summary of these results is shown in Figure 1. The contour lines in 1A represent the distribution of cells in the PC layer of the unfolded cerebellar cortex according to the amplitude of their

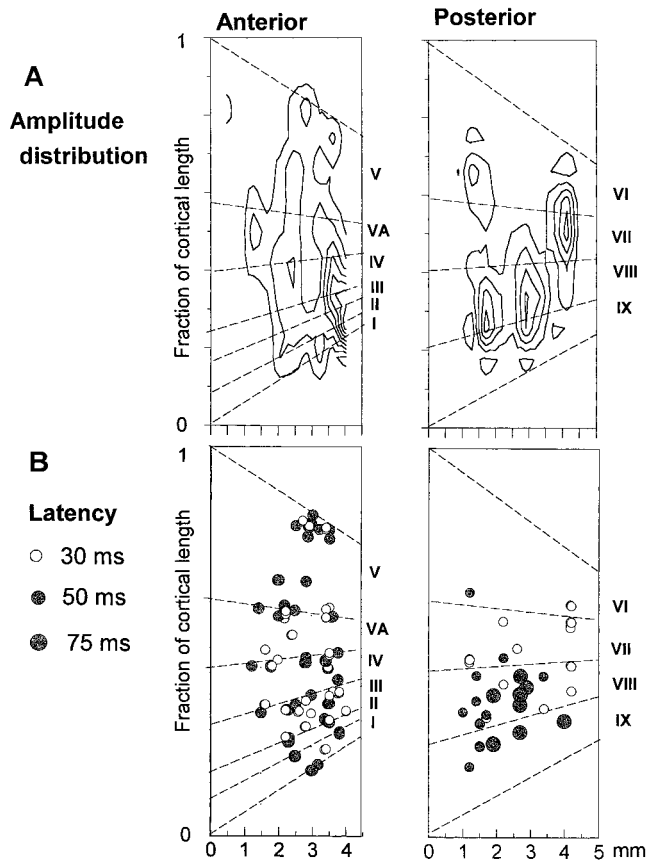

Figure 1 (Poppele & Bosco). *Purkinje cell responses to ankle rotation mapped onto the unfolded cortex of the spinocerebellum.* Map coordinates are: distance in mm from the midline (abscissa), and anterior-posterior position of each cell along the PC layer (ordinate). Position is expressed as a fraction of the PC layer length in each lobe. Dashed lines indicate approximate boundaries between lobules. *A.* Contour maps of the distribution of PC response amplitudes. Contour peaks represent locations of the largest responses. *B.* Locations of PCs according to response latency (time between rotation onset and peak activity) indicated by different symbols.

responses to ankle joint rotation. The anterior lobe contains at least two regions in lobules II–V with large amplitude responses, separated by bands with small amplitude responses. There were at least three such regions in the posterior lobe.

Focussing first on the anterior lobe, we could argue that a primary locus of activity in the lateral part of lobule II corresponds to the classical somatotopic area of the ankle (Adrian 1943). Furthermore, more medial cells with weaker responses may have responded to mechanical perturbations propagating proximally along the limb from the ankle rotation. This interpretation is consistent with the model assumptions, although a similar interpretation cannot account for the distribution of responses in the posterior lobe. Nevertheless, if we accept the mechanical perturbation analysis, the model predicts the latency of responses will increase medially across the cortex as the perturbation progresses from distal to proximal along the limb. This is not, however, what we observed.

In Figure 1B, we plot the locations of PCs using symbols that correspond to the approximate latency of each response peak. The largest responses in the anterior lobe tended to have the shortest latencies as predicted, however response latency did not vary systematically with cell location. Although there was a more systematic relationship in the posterior lobe, it did not show a continuous progression.

Based on these findings, we find it difficult to account for the observed spatio-temporal organization of PC activity in the context of the proposed theory. The notion that the geometry of the cerebellar cortex may play a unique role in its function remains an attractive idea, but the current proposal seems oversimplified and lacks relevant or substantial experimental support.

#### ACKNOWLEDGMENT

The research was supported by a grant from the NIH (NS21143).

### Stochastic recruitment in parallel fiber activity patterns

Patrick D. Roberts

R. S. Dow Neurological Sciences Institute, Portland, OR 97209.  
proberts@reed.edu

**Abstract:** Random-excitation granule cells are likely to overwhelm spatiotemporal sequences described as “tidal waves” in Braitenberg et al.’s target article. A mechanism is proposed involving the Golgi cells to reinforce tidal waves against noise. The recurrent inhibition by the Golgi calls can recruit random excitations of granule cells in phase with sequences of mossy fiber input.

**Noisy issues.** Braitenberg et al.’s target article presents intriguing experimental support for the propagation of waves in parallel fibers, but the potential effects of the noise inherent in the nervous system has not been thoroughly addressed. Random excitations of granule cells can make a significant contribution to Purkinje cell activity. For each parallel fiber that contacts a Purkinje cell there is a 50% chance that a spike originated in a granule cell on a particular side. Let  $N$  be the number of parallel fiber spikes required to induce a simple spike from a Purkinje cell. The probability that of  $N$  spikes converging on the Purkinje cell,  $l$  of them came from one side,  $P(l; N - l)$ , is equal to the number of combinations of  $N$  spikes taken  $l$  at a time, divided by the total number of possibilities for spikes arriving from either side;

$$P(l; N - l) = \frac{N!}{l!(N - l)!} \cdot 2^{-N}. \quad (1)$$

The number of simultaneous parallel fiber spikes required to excite a single simple spike is found to be  $N = 50$  (Barbour 1993). This would imply that the probability that all of the impulses come from one side is  $P(0; 50) \approx 10^{-15}$ . In contrast, the probability that the signals are equally distributed on either side is  $P(25; 25) \approx 0.1$ . The statistics implied by the function  $P(l; 50 - l)$  suggest that the amount of simple spike activity induced by noise would overwhelm the appearance of temporal sequences along the beams unless either the noise level is very low, or there is a mechanism that reinforces the temporal sequence in the presence of fluctuations.

**Golgi inhibition.** The Golgi cells have been implicated in temporal sharpening of granule cell activity (Eccles et al. 1967). Although the authors of the target article state that the Golgi cells act mainly to “put a brake on” local activity, the recurrent inhibition induced on granule cell activity can lead to pattern formation. In species such as mammals where the Golgi dendrites reach deep into the molecular layer, a large portion of their input will arise from parallel fiber signals. Let  $E(x, t)$  be the instantaneous firing frequency of granule cells at time  $t$  and point  $x$  along the beam (in the coordinates of the target article). In the molecular layer, signals split into two populations: “right movers” and “left movers,”  $M_{R,L}(x, t) = E(x \pm (vt + \Delta x_a), t - x/v)$ , where  $\Delta x_a$  is the average length of the ascending fibers.

To study the consequences of granule-Golgi cell interactions, an activation-inhibition model (Ermentrout & Cowan 1979) will be used. The granule cells excite the Golgi cells which respond with a

delayed inhibitory response. In parallel fibers, this time delay is transformed into a spatial interval. If  $I(x, t)$  represents the instantaneous firing frequency, then one is led to the equations

$$\begin{aligned} \frac{\partial}{\partial t} E(x, t) &= f(E) - \int_F \omega_I(x - x') I(x', t) dx' \\ \frac{\partial}{\partial t} I(x, t) &= g(I) - \int_F \omega_E(x - x') [M_L(x', t) + M_R(x', t)] dx'. \end{aligned} \quad (2)$$

The functions  $f$  and  $g$  set the background firing level and possible thresholds of the corresponding cell population, and the integral is over the length of the folium ( $F$ ). The kernels,  $w_i(x)$ ,  $i = I, E$ , denote the spatial extent of the interaction and can take the general form,  $w_i(x) = A_i \exp[-b_i x^2]$ , where  $b_i$  is a function of the spread of Golgi dendrites in the molecular layer along the beam, and  $b_I$  is related to the spread of Golgi axons in the granule layer. The constants,  $A_i$ , are determined by the interaction strength between the neuronal populations. These equations are presently under study and belong to a large class of models that can spontaneously generate spatiotemporal patterns.

**Patterning of tidal waves.** Qualitatively, under random excitation of the granule cells, there is a sinusoidal modulation of parallel fiber activity at a frequency that depends on the ascending fiber length ( $\Delta x_a$ ). The amplitude of this modulation will depend on such factors as the spatial extent of Golgi dendrites and axons, the distribution of ascending fiber lengths, and the synaptic strength connecting the populations. These features have been checked using a cellular automata simulation of the parallel fiber system.

Our patterning results are relevant to the discussion of "tidal waves" under the combinatorial constraints mentioned above. If a temporal sequence of granule cell spikes make a moving wave in the right (left) movers ( $M_{R(L)}(x, t)$ ), then there will be a right (left) moving trough following the wave. The trough will then silence the Golgi cells and allow a higher probability of granule cell activity in phase with the wave. Thus, the cerebellar circuitry allows for the *recruitment of noise* in phase with the wave. Thus, the cerebellar circuitry allows for the *recruitment of noise* in phase with the stimulus while the noise is suppressed elsewhere. This effect can continue even *beyond the length of the parallel fibers* that carried the original tidal wave, thus propagating the signal across the folium. Although Golgi cells also receive inputs from both mossy and climbing fibers that will effect the propagation of activity waves, the mechanism proposed here can lead to significant consequences for cerebellar function.

## Spatio-temporal constraints of the tidal wave theory

Cornelius Schwarz

Sektion für Visuelle Sensorik, Neurologische Universitätsklinik  
Tübingen, 72076 Tübingen, Germany. [cornelius.schwarz@uni-tuebingen.de](mailto:cornelius.schwarz@uni-tuebingen.de); [www.uni-tuebingen.de/uni/knv/](http://www.uni-tuebingen.de/uni/knv/)

**Abstract:** The tidal-wave theory is inspired by the particular morphology of the cerebellar cortex. It elegantly attributes function to the anisotropy of the cerebellar wiring and the geometry of Purkinje cell dendrites. In this commentary, physiological considerations are used to elaborate temporal and spatial constraints of the tidal-wave theory. It is shown, first, that limitations of temporal precision in the cortical inputs to the mammalian cerebellum delimit the spatial resolution of an input sequence (i.e., the minimal distance along the parallel fibers which can detect sequential input) to the range of a millimeter at best. Second, temporal characteristics of Purkinje cell postsynaptic potentials are argued to predict a distance of at least several millimeters along the parallel fiber beam in order to generate a sequence in the cerebellar output. It is concluded that the implementation of tidal waves as a general principle of cerebellar function is questionable as there exist cerebelli too small to match these constraints.

**Temporal limitations in the mossy fiber inputs set the minimal distance on the parallel fiber beam required to decide between synchronicity and sequence.** How could two neighboring Purkinje cells get precisely timed inputs appropriate to elicit a tidal wave? If one assumes the width of Purkinje cells as  $10\mu\text{m}$ , such a sequence would have to arrive with a latency of about  $20\mu\text{s}$ . It is conceivable that peripheral parts of the nervous system are able to yield a high precision in the timing of their spikes. In the cerebral cortex, however, a structure which is a major source of inputs to the mammalian cerebellum covering almost all its regions (Brodal & Bjaalie 1992), the content of information present in precisely timed spikes is still a matter of debate (Shadlen & Newsome 1994; Softky & Koch 1993). Even when considering only those authors who argue in favor of a precise cerebrocortical time code, the most optimistic judgements of temporal precision are on the order of a millisecond (Lestienne 1996; Mainen & Sejnowski 1995; Softky 1994). The precision of correlated firing by different cerebrocortical neurons has been reported to reach this value (Abeles 1990) but in most studies it has been observed to be much lower (discussion in Nelson et al. 1992). Accepting the optimistic value of 1 msec, two cerebrocortical spikes delayed by less than 1 msec should be judged as "synchronous" by an optimized postsynaptic coincidence detector whereas they should be read as "in sequence" in all other cases. If such synchronous activity (assuming that the precision is preserved along the cerebrocerebellar pathway) enters the parallel fiber beam at one point, the temporal inaccuracy will be transformed into a spatial dispersion of about  $500\mu\text{m}$  length due to the propagation along the parallel fibers. Consequently, two inputs timed to elicit a tidal wave will occupy a distance of at least 1 mm along the parallel fiber beam in order to be securely detected as a sequence. Thus, even optimistic assumptions of the temporal precision in these inputs yield a spatial resolution which is poor compared to that suggested by the width of Purkinje cell dendritic trees ( $10\mu\text{m}$ ).

**Temporal characteristics of Purkinje cell synaptic potentials limit the generation of output sequences.** Braitenberg et al. maintain that a given sequence in the parallel fiber *input* necessarily also causes a sequence in the *postsynaptic* Purkinje cell *output* ("sequence in-sequence out"). However, the function which is given in order to express the local density of excitation incorporates exclusively parameters specific for parallel fibers, the *input* to the system. In order to generalize this function for the *output* ( $A_{\text{out}}$ ), the time span of the Purkinje cells' elevated firing probability during a parallel fiber-induced EPSP ( $t_{\text{EPSP}}$ ) has to be taken into account. This idea has been incorporated in the authors' formula as follows (see target article for details):

$$A_{\text{out}} = \frac{E}{(\Delta x/v|v - v_0| + d + d_{\text{EPSP}})}$$

where  $d_{\text{EPSP}} = t_{\text{EPSP}} * V_0$ . In order to derive an approximation for  $t_{\text{EPSP}}$  two arguments have to be considered. First, as Purkinje cells show a sustained background activity *in vivo* and *in vitro*, their membrane potential is above or near threshold at any instance of time. Even small depolarizations will therefore reach threshold and lead to an elevation of the firing rate. Second, as Purkinje cells lack an adaptation of their firing rate, long depolarization will be transformed into a tonic elevation of the firing rate (Jaeger & Bower 1994; Llinás & Sugimori 1980). Therefore, the length of an EPSP itself can be taken as a first approximation of  $t_{\text{EPSP}}$ . A conservative estimation of the length of a single parallel fiber EPSP is the sum of the time constants of rise and fall of the underlying synaptic currents which comprises about 10 msec in the soma (Barbour 1993). It follows that the minimum distance a tidal wave has to travel in order to achieve a reasonable local density function in the *output* activity ( $\Delta x = d + d_{\text{EPSP}}$ ; see Fig. 6a of the target article) can be judged to range about 7 mm. For the more favorable situation shown in Fig. 6b, a  $\Delta x$  of 70 mm is needed ( $\Delta x = 10 * (d + d_{\text{EPSP}})$ ). Prolonged parallel fiber EPSPs in the

range of hundreds of milliseconds which have been reported recently (Jaeger & Bower 1994; Larson-Prior et al. 1990) would require respective values of  $\Delta x$  of 52 and 520 mm (assuming a length of the EPSP of 100 msec).

**Conclusion.** In order to formulate a general theory, the distance that the *smallest* cerebelli in regions of their *smallest* laterolateral extent can accommodate for the build-up of tidal waves has to be considered. A small cerebellum (e.g., that of the bat or the mouse which are demonstrated in Figs. 1 and 2 of the target article) displays laterolateral extensions as small as 1 mm (e.g., in posterior regions which readily receive cerebral inputs via pontocerebellar fibers, see for review Brodal & Bjaalie 1992). Thus, as stated above, these extensions support just two sequential cortical inputs based on the most optimistic assumptions about their temporal precision. Longer sequences consisting of many successive inputs, which seem to be desirable, are not supported by these regions. Furthermore, the requisite length for achieving a satisfactory level of sequential activity in the output of a given tidal wave is not reached at all, even if one assumes the most opportune values of  $\Delta x$  as given above. Therefore, based on the present considerations, the prerequisites for the generation of tidal waves are not offered in every region of small cerebelli. To make the theory acceptable as a general one (which has to be provided in view of the highly preserved cerebellar morphology across species and across cerebellar regions), the precision in the cerebellar inputs as well as the precision of Purkinje cells in the detection of synchronous inputs must be shown to be substantially higher than has hitherto been reported.

## The job description of the cerebellum and a candidate model of its “tidal wave” function

Robert E. Shaw,<sup>a</sup> Endre E. Kadar,<sup>b</sup> and M. T. Turvey<sup>a</sup>

<sup>a</sup>Center for the Ecological Study of Perception and Action, University of Connecticut, Storrs, CT 06269. [cespal@uconnvm.uconn.edu](mailto:cespal@uconnvm.uconn.edu)

<sup>b</sup>Department of Psychology, University of Portsmouth, Portsmouth, PO1 2DY, United Kingdom.

[kadare@psy1.psyc.port.ac.uk](mailto:kadare@psy1.psyc.port.ac.uk); [www.sci.port.ac.uk](http://www.sci.port.ac.uk)

**Abstract:** A path space integral approach to modelling the job description of the cerebellum is proposed. This new approach incorporates the “tidal wave” equation into a kind of generalized Huygens’s wave equation. The resulting exponential functional integral provides a mathematical expression of the inhibitory function by which the cerebellum “sculpts” the intended control signal from the background of neuronal excitation.

**The job of the cerebellum.** In a nutshell, the job of the cerebellum involves a distribution of well-timed inhibitory volleys that has been described as a process that, without benefit of positive feedback (target article, sect. 4), “sculpts” the motor sequences out of background excitation (sect. 25). Furthermore, it does so in keeping with the cerebrally stipulated intention and the requirements of the perceptually informed physics of the action system. The “sculpting” function is envisaged as a unidirectional sum of local “tidal wave” effects acting transversely over neighboring folia that each contain “beams” of neural impulse in their parallel fibers. These effects reach maximal amplitude when the speed of a neural impulse approximates the conduction rate of the parallel fibers, diminishing otherwise, and virtually disappearing if the signal moves counter-directionally. The formal description offered here purports to capture the chief characteristics of the function that sculpts out of the spatio-temporal distribution of all possible motor control signals the intended motor control signal.

First, for a most natural description, the sculpting function requires a functional integral formulation. As it now stands, with continuous variations in all parameters, the tidal wave equation (sect. 14) implies a system of differential equations that is potentially infinite in number (Kramer 1970).

Second, the fact that the distribution function sculpts away from the excitation the control signal needed, suggests a need for a generalized form of Huygens’s famous principle of constructive and destructive wave interference (where his time variable is replaced by Lagrange’s action variable) (Lanczos 1970).

Third, because the cerebellum must accommodate a potentially astronomical number of such sculpting functions, all possible paths through the lattice-like structure of the cerebellum are needed. Selection of the proper control signal by the cerebellum (as constrained by perception, with or without learning) entails solving a two-point boundary problem (e.g., the time interval for serial volleys crossing the folia, sect. 9); this involves a kind of “least action” principle, similar to variational solutions (but see caveat in commentary by Kadar et al., this issue). Fortunately, a functional integral approach for solving such problems exists. It is called a *Feynman path space integral* (Feynman & Hibbs 1965), and is our candidate for modeling the proposed job of the cerebellum; moreover, its use in perceptually informed motor control tasks has already been introduced (Shaw et al. 1994).

**Formulating that job with path space integrals.** The equation for the inhibitory functional distribution that will sculpt away all excitation except the intended path (normalized here to be the stationary path solution) takes the following generic form:

$$K(b, a) = \lim_{\varepsilon \rightarrow 0} \frac{1}{k} \int \int \int \dots \int e^{i(\varepsilon/\alpha)S[b,a]} \frac{dx_1}{k} \frac{dx_2}{k} \dots \frac{dx_{N-1}}{k} \quad (1)$$

$$= k \int_a^b e^{iS/\alpha} Dx(t)$$

This is a path space integral that defines all the possible paths in the space-time distribution,  $Dx(t)$  (for a vector function of 1, 2, or 3 spatial dimensions), from an initial time site  $a = x_0(t_0)$  to a final time site  $b = x_1(t_1)$ . Here the “tidal wave” term (sect. 14) is inserted into the exponent to redefine the (Lagrangian) action term,  $S = Axt$ , and  $k$  is the normalizing factor to keep the series from diverging (Feynman & Hibbs 1965). The constant  $\alpha$  refers to the smallest unit of neural action possible (possibly related to the refraction period of conduction in the parallel fibers) – descending on Planck’s constant if the volleys are quantum effects and on zero if beams approximate continuous functions. Perhaps, better still for neural purposes is to define  $\alpha$  as an elementary Gabor function,  $\alpha = a \text{ logon unit}$  (Pribram 1991).

**Two caveats.** A. If complex number solutions are not needed, Equation (1) can be transformed into a real number (Brownian) path space functional by a Wick rotation, according to the Feynman-Kac Theorem, by replacing  $t$  by  $it$  in the exponential (Roestorff 1994). However, if the quantum nature of the brain is established (e.g., vis-à-vis micro tubules), probability amplitudes might be needed to handle quantum interfering paths, demanding both the real and complex conjugate solutions to Equation (1) (Jibu & Yasue 1995). B. To model the cerebellum as a lattice of orthogonal inhibitory and excitatory dimensions (sect. 3), Equation (1) can be rewritten for physics of “zig-zag” paths on a lattice (Roestorff 1994).

## The cerebellum and the physics of movement

Helge Topka and Johannes Dichgans

Department of Neurology, University of Tübingen, 72076 Tübingen, Germany. topka@uni-tuebingen.de

**Abstract:** This commentary reviews the basic physical principles underlying human single- and multi-joint arm movements. The potential role of the cerebellum in dealing with the physics of movement is discussed in the light of recent physiological findings and the theoretical model of cerebellar detection and generation of input and output sequences put forward by Braitenberg and colleagues.

Several lines of anatomical and physiological evidence point to a rôle of the cerebellum in dealing with the mechanics of movement. Thus, the theoretical model proposed by Braitenberg et al. fits well with the emerging concept of cerebellar motor control and may provide timely insight into its mechanisms at the unitary level. The scheme proposed by Braitenberg and colleagues appears to provide a basis for reconciliation of a large number of previous anatomic and physiological findings. In our view, however, two main issues require further consideration. One concerns the proposed mechanical model of cerebellar control of movement, the other the organization of “tidal waves” within the cerebellar cortex.

The proposed model is derived from single-joint studies and hence may well be suitable to explain a number of clinical and physiological findings in cerebellar limb ataxia such as disordered sequences of agonist and antagonist activation or dysmetria. It may provide an explanation for delayed antagonistic activation. However, it neglects the fact that the cerebellum is not only involved in programming the timing of antagonistic muscles in reaction to reafferent input but is also involved in the task-adequate control of the initial agonistic burst (Hallett et al. 1975; Hore et al. 1991; Wild et al. 1996).

In addition, one may criticize the proposed mechanical model for its simplicity. The mechanics of natural multi-joint movements is far more complex than single-joint movements suggest. For example, a single-joint mechanical model with a pair of antagonistic muscles does not account for interactions between limb segments, which complicate natural movements that frequently involve motions about multiple joints. Mechanically, the human body represents a multi-segmented system of linked bodies. In order to perform accurate movements, task-adequate intersegmental coordination is required, particularly if movements are performed in three-dimensional space. To achieve coordination among multiple limb segments, muscle torques at each joint have to be adjusted to account for the effects of gravity (Virji-Babul et al. 1994). In addition, in a multiple link mechanical structure, motions of any one part of the linkage exert forces (passive reaction forces) on the remaining parts. It is well documented that muscles are able to cause movement about joints they do not span by means of passive reaction forces (Almeida et al. 1995). Recent physiological studies in healthy subjects and patients have demonstrated that reaction forces arising during multi-joint movements are sufficiently large to influence movement trajectories, if not compensated for (Hollerbach & Flash 1982; Sainburg et al. 1995; Virji-Babul & Cooke 1995). Therefore, in order for a coordinated multi-joint movement to occur, the central nervous system has to provide mechanisms that allow for actively counterbalancing passive reaction forces and gravitational forces. The requirement of actively counterbalancing passive interaction and gravitational forces implies that the central nervous system provides for mechanisms that allow for rapid and accurate evaluation of the sensory consequences of movement.

Regardless of the simplicity of the proposed mechanical model, however, the general role of the cerebellum in controlling the mechanics of movement derived from a single-joint model may well apply to multi-joint movements as well. The intrinsic anatomy of the cerebellar cortex and its associated cerebellar nuclei – in

particular, the presumed fractured somatotopy of mossy fiber input to the cerebellar cortex – may represent an ideal substrate to modulate the activation of adjacent joints and synergistic muscle groups and to relay information on mechanical consequences of movements between different segments of the body. Recent studies on the pathophysiology of cerebellar ataxia support the notion of cerebellar control of movement dynamics on a behavioral level (Bastian et al. 1996; Topka et al. 1996). Multi-joint limb movements in cerebellar ataxia are associated with reduced muscular forces inappropriate to compensate for the complex effects of gravitation and passive interaction forces that arise in a mechanical system such as the human arm. Consequently an abnormal influence of gravitational and passive interaction forces in the face of cerebellar dysfunction, causes kinematic aberrations such as hypermetria and reduced angular acceleration and deceleration. These findings and the results of recent studies on cerebellar involvement in motor adaptation (Hallett 1996) support the notion that cerebellar pathways are involved in assessing and evaluating the sensory consequences of movement and adapting motor output to serve the purpose of the task.

The concept of sequence processing within the cerebellar cortex and its associated circuitry as proposed by Braitenberg and colleagues provides a theoretical model of cerebellar function on the unitary level that is compatible with the notion of cerebellar involvement in dealing with the physics of movement. However, some concerns with respect to the proposed mechanisms of cerebellar involvement may require additional experimental verification. One concern is with the nature of the input sequence that gives rise to the “tidal waves.” Experimental tidal waves elicited by a sequence of electrical stimuli to the granular layer of the cerebellar cortex depend critically on the characteristics of the electrical stimuli applied and these electrical stimuli may not match the input sequence of granular cell activation during voluntary movement. To ensure the biological relevance of tidal waves, experimental evidence should accordingly demonstrate that input sequences as observed in the granular cell layer during voluntary movement are of the same characteristics as the experimental electrical stimuli. To our knowledge this has not yet been verified.

Braitenberg and colleagues do show convincingly that the local density of tidal waves depends on the velocity of the input sequence. The question then arises as to how input sequences are processed within the cerebellar cortex that arise from movements that are performed at different speeds. Assuming that an optimal input sequence velocity gives rise to maximal density tidal waves, and assuming that the conduction velocity of parallel fibers is roughly the same throughout the cerebellar cortex, the proposed mechanism predicts that the intensity and pattern of cerebellar cortical activation is related to the speed of movement. Clinical and physiological observations support the notion that kinematic abnormalities in cerebellar ataxia, in general, are velocity-dependent. Numerous studies have demonstrated that abnormalities are most prominent with fast movements while aberrations during slow movements are relatively minor (Hallett & Massaquoi 1993; Hallett et al. 1975; Holmes 1939; Hore et al. 1991; Massaquoi & Hallett 1996; Meyer-Lohmann et al. 1977; Topka et al. 1996). However, the exact nature of this velocity-dependent failure remains unclear.

The mechanism proposed by Braitenberg and colleagues implies that input sequences generated by movements of different velocities affect different sets of Purkinje cells. Although representing movements of different velocities in a look-up table of sets of Purkinje cells constitutes one solution to control movements of different velocities, it is not at all clear if the central nervous system actually utilizes such a mechanism. Inherently, look-up table representations pose restrictions, such as a limited versatility or limitations in adaptive capabilities that cast some doubt on the biological utility of such a mechanism. Experimental evidence that helps to clarify this issue is not available at this point.

## Detection of input sequences in the cerebellum: Clinical and neuroimaging aspects

P. Trillenberger and K. Wessel

Department of Neurology, Medical University of Lübeck, D-23538 Lübeck, Germany. wessel@medinf.mu-luebeck.de; www.neuro.mu-luebeck.de/fgwessel.htm

**Abstract:** We add evidence from functional imaging supporting the concept of activation of coronally oriented zones corresponding to parallel fibers. Braitenberg et al.'s suggestion that there is an operating mode of the cerebellum relies on the idea introduced by Eccles and refined by the concept of tidal waves which Heck found *in vitro*. Recent evidence from functional imaging has shown zones of activation in accordance with this model and hence provides support for Braitenberg et al.'s hypothesis from the intact and healthy human cerebellum. In a second section, we discuss vulnerability of the structures described by Braitenberg et al. with respect to slow and fast movements in the context of clinical symptoms in cerebellar disease.

**1. From beams to tidal waves: present and future evidence from neuroimaging.** Braitenberg et al. pick up Eccles's idea of coronally oriented "beams" as a functional unit of the cerebellar cortex which correspond anatomically to parallel fibers and refine the idea with the concept of tidal waves elicited by subsequent inputs in an appropriate temporal order. So far, the hypothesis is only based on *in vitro* results, but now functional magnetic resonance imaging (fMRI) allows us to study these questions in humans as well.

Whereas PET studies showed bilateral focal activation in relation to simple motor tasks such as finger movements (Fox et al. 1985), recent data from fMRI reveal patterns of activation in the cerebellum that could be generated by beams and their interaction with sagittal bands. Three modes of activation are commonly observed:

First, there are mediolateral bands of activation in the anterior cerebellum in relation to self-paced ipsilateral hand movements (Nitschke et al. 1996) and in relation to externally paced wrist flexion and forearm extensions against loads of two different weights (Ellerman et al. 1994). The visible pattern suggests against activation of separated folia, but careful interpretation is warranted because the activation pattern in the form of mediolaterally orientated stripes can be due to the folding of cerebellar folia so that parts of activated cortex are not covered by the imaging slice. The activated zones span a mediolateral distance of ca. 3 cm in Ellerman's study and at least half of a folium in Nitschke's maps. Nitschke also reported activation for foot movements. These areas were located anteriorly and medially to the hand area and followed a mediolateral pattern also.

A second pattern described by Ellerman consists of an ipsilateral parasagittal strip for movements against heavy loads and two parasagittal strips for movements against light weights. Third, both Ellerman and Nitschke report a mosaic-like bilateral pattern of activation in the posterior lobe and vermis of the cerebellum. In general, these results give some further support for the beam concept. Concerning the question of beam length (Braitenberg et al., sect. 17), the fMRI findings suggest that beam length exceeds the length of one individual parallel fiber, as proposed by Braitenberg et al.

To get *in vivo* evidence for the more detailed tidal wave concept, fMRI should be used to map activation in relation to tasks with varying velocity. Following the line of arguments in section 21 of Braitenberg et al.'s target article, it could be predicted that fast movements are represented on shorter folia which are lying more anteriorly. This can be concluded under the assumption that the velocity of tidal waves is the same for all folia and that sagittal strips, providing input, extend over the whole anterior-posterior diameter of cerebellum.

**2. Can the tidal wave concept be related to clinical presentation of cerebellar disease?** It is interesting to note that cerebellar

symptoms are associated with fast movements and with slow movements as well: astasia (i.e., clonic, jerky character of movements; Holmes 1922) is most obvious for slow movements. Hore & Flament (1986) found transition into kinetic tremor for extremely slow movements and report improvement of kinetic tremor by attachment of additional weights to the affected limb. Hypermetria (i.e., overshooting amplitude of movements) is most pronounced for fast movements (Holmes 1922) and worsened by additional weights attached to the affected limb, which can even be used to provoke symptoms of cerebellar disease (Manto et al. 1995). There are conflicting results with respect to intention tremor which has been reported to improve with the addition of weights on the one hand (Hewer et al. 1972) and which has been attributed to faulty correction of hypermetria on the other hand (Vilis & Hore 1977).

The best explanation for the worsening of symptoms with both high velocity and additional weights are the increased "parasitic forces" as mentioned by Braitenberg et al. (sect. 22). Apart from a passive mechanical aspect (which cannot account for the whole effect, since disturbances last for several seconds, see Vilis & Hore 1977), Figure 6 from Braitenberg et al. shows tuning of parallel fibers to be less precise for fibers detecting high velocities (low  $\Delta x$  in equation in sect. 14) making them more vulnerable to a cerebellar lesion. In contrast,  $\Delta x$  is large for low velocity fibers. Therefore, a tidal wave has to travel a great distance before it is reinforced by the next input and the tidal wave might fail to build up by losing activation due to conduction deficits, which in particular worsens slow movements.

## Authors' Response

### Waiting for the ultimate theory of the cerebellum

Valentino Braitenberg,<sup>a</sup> Detlef Heck,<sup>b</sup> and Fahad Sultan<sup>c</sup>

<sup>a</sup>Max-Planck-Institute for Biological Cybernetics, 72076 Tuebingen, Germany; <sup>b</sup>University of Freiburg, Institut für Biologie III Neurobiology and Biophysics D-79104 Freiburg 1. Br. Germany; <sup>c</sup>Section für Visuelle Sensomotorik Neurologische Universitätsklinik Tuebingen 72076 Tuebingen, Germany. schuez@sunwan.mpib-tueb.mpg.de; heck@biologie.uni-freiburg.de; sultan@mail1.mpib-tuebingen.mpg.de

**Abstract:** Although our idea of sequential input being a key to cerebellar function was taken seriously by most commentators, there were also objections, based in part on experimental evidence that seems to contradict our intuitions and in part on commentators' preferences for different schemes. Several were suspicious of experiments (performed on slices of cerebellar tissue) that may have severed some of the synaptic connections, particularly the inhibitory ones. It is our feeling that a modification of our theory that could satisfy most critics would not have to be very radical.

As expected, the commentaries which our distinguished colleagues kindly have provided are of three kinds. Some accept the idea, but suggest modifications or extensions. Others point out facts and discrepancies which they believe make it untenable. And then there are some who think it could well be otherwise. If this were a parliament, we would have 15 supporters (including some lukewarm ones), 5 members against us, and 5 who would rather talk about something else.

## R1. "Yes, but . . ."

The idea that it is temporal sequences rather than synchronous input to which the cerebellum is tuned, appears to find some support. But there are commentators (**Harvey** and **Meek**) who doubt the generality of the principle, because the uniformity of cerebellar anatomy on which it is based has its exceptions. Some parts (to be sure, the most impressive ones) of the cerebellum of some electric fish (the Mormyrids) have their granular cells collected on one side of the folium, making the idea of sequentially activated rows of input points quite implausible. The "valvula" of the mormyrid cerebellum is also different in other ways (Niewenhuys & Nicholson 1969), with its extremely flat Purkinje dendritic trees stacked so closely that the temporal resolution of the system, if it plays any role there, is one order of magnitude better than in other cerebella. Evidently, in these peculiar fish the ancient scheme of the cerebellar neuropil has been adapted to fulfill some special purpose, probably connected with the electric signalling system which they use for orientation and intra-species recognition. We accordingly feel justified in excluding the cerebellum of electric fish from the generalization of cerebellar anatomy across species which served as our starting point.

Parallel fibers come in pairs, originating from the same ascending axon of a granular cell and running in opposite directions. (It is interesting to note that the exception is again in the valvula of the Mormyrid cerebellum, where parallel fibers do not bifurcate.) This striking feature plays no rôle in our model, and may even require a modification of it (**Harvey**, **Lidierth**, and **Meek**). In fact, if a folium or a beam serves the purpose of detecting sequential input "moving" in one direction, only one of the branches of the T-shaped bifurcation is needed to sustain the travelling wave; the other would just add noise. This requires additional explanation, which at present can only be tentative. We suggest that the molecular layer of the cerebellum does not know in advance in which direction the regular input sequences it is prepared to detect will run. It may even learn to react differently to sequences involving the same elements but moving in opposite directions, activating the Purkinje cells on either side of the set of input points.

Parallel fibers running in opposite directions have inspired an idea which is as fascinating as it is difficult to uphold in detail (**Harvey**, **Lidierth**, **MacKay**, and **Meek**). A Purkinje cell would be most strongly excited if it were reached at the same time by two travelling waves coming from opposite directions. The time and place of the maximally excited Purkinje cells would say something about the relatedness of the input sequences coming from both sides, and about possible time shifts between them (Lidierth). We had proposed a similar idea, which we called "coincidence and time shift detection" or "cross correlation" in one of our earliest versions of cerebellar theory (Braitenberg 1961), but later dropped it as a general principle. Again, in the special case of the Mormyrid cerebellum (*lobus transitorius*) the histology seems ideally suited to sustain such cross-correlations (Meek), and this interpretation is quite appealing even in the frog cerebellum (where parallel fibers reach from one end to the other). But we do not see how the principle could also operate in larger cerebella, because we have not yet been able to assign any meaning to a function that is computed at any point of the cerebellar cortex for any

pair of input sequences reaching the cortex a few millimeters to the right and to the left of it. Where intuition fails, mathematical theory may show the way, but it has not done so yet.

There are commentators who remind us of some physics and mathematics we should know or should apply in a less lighthearted way. The movements of an arm are more complicated than those of a toy cart (**McCollum**, **Morasso** & **Sanguineti**, **Topka** & **Dichgans**). We are aware of this. With three segments and two joints, there are intersegmental interactions, forces or pseudoforces that vary as the square of the first derivative of one joint angle, or as the product of the square of the first derivative of one angle by the other angle, or as the product of the first derivatives of the two angles, or as the second derivative of one angle, not to mention viscosity and elasticity. We had hoped that our simple example with masses and springs would make the general principle clear in an intuitive way without implying that this is all there is. After all, with small displacements, a stretched spring is a good model for any kind of force. Clocks with springs have successfully replaced the mass-inertia-gravitation action of the pendulum in the grandfather clock.

In some of the commentaries (**Kadar et al.**, **Shaw et al.**), our humble ideas, clad in the language of theoretical physics, were raised to heights that we cannot easily reach. We feel impressed and honored. It is quite possible that the tidal wave emerging from a generalized Huygens wave equation will reveal properties that have hitherto escaped us, and the dependence of local activity on global excitatory and inhibitory cross-talk may follow a principle of least action in a way best described by the Feynman path space integral. Whether these are just metaphors, or useful tools, or essential mathematical similarities remains to be seen.

The commentary by **Chauvet** also laments the absence of mathematics in our work. Even if the commentary does not contain any explicit mathematics, this commentator refers to a theory of the cerebellar cortex which he has published before and of which we are well aware. We apologize for not having cited it in our target article. The commentary stays closer to biological reality despite some loan-words from quantum mechanics (field theory, non-locality). It turns out that the facts which Chauvet extracts from the vast body of experimental evidence are somehow complementary to the ones that we chose as our data base, namely the local circuit around the Purkinje cell, plasticity (learning rules), and global, hierarchical operation. True, we passed over the role of the Golgi cell in silence because in a first pass we preferred to discuss the elements that are involved in spatio-temporal transformations, and the Golgi cell is not. We did leave it to the imagination of the reader to define the precise conditions for learning in the various synapses involved, and we are grateful for any experimental work or computer simulation that will help specify them. Also, the global operation of the cerebellar cortex is something we deliberately ignored, because of the striking lack of corticocortical connections that distinguishes the cerebellar cortex from the cerebral cortex.

Another theoretical remark which may considerably improve our theory is contained in the commentary by **Roberts**, who is concerned with the problem of noise in the system that had worried us too (though not explicitly in our paper). Again, the Golgi cell appears as the *deus ex machina*



which may transform disturbing noise into something that actually enhances the travelling wave.

A recurrent theme with our readers and commentators is the suspicion that the cerebellum is not so much a motor center as one involved in all sorts of sensory and even cognitive functions (**Courchesne, Miall, Molinari & Petrosini, Paulin**). The commentary by Paulin is a plea for epistemological correctness and a warning against preconceived notions (such as the cerebellum as a motor control organ) that may survive without factual support or logical necessity. Courchesne is more explicit in his revolutionary approach, and underpins his view with experimental evidence. In the end, however, his reasoning converges onto something not very different from what we propose: prediction of sequels of sequences (which is why we include him among our supporters). The commentary by Molinari & Petrosini is particularly interesting, not only because of their positive attitude towards our hypothesis, but also because of the wealth of experimental evidence they have collected on impaired cognitive functions in cerebellar patients. It should be noted, however, that the time scale of their experiments is not the same as what we had in mind in our sequence-in/sequence-out scheme. On the whole, we find the latter three commentaries quite encouraging and not at all in contrast with our model, which is after all more about how the cerebellum evaluates its input (from the cortex and from the periphery) than about what it contributes to the motor outflow.

Not everyone agrees with the details of our model. **Harvey**, besides noting our indifference in the face of the biochemical diversity of Purkinje cells and in general about their cytophysiology, wonders how our scheme deals with the sagittal zones of the cerebellar cortex which have by now been well established. Moreover, he finds the convergence of many Purkinje cell axons onto the same cells of the cerebellar nuclei difficult to understand in terms of our model. We find that the latter point rather speaks in favor of it. If Purkinje cells in various beams make their (inhibitory) contributions to the same motor units in different motor contexts, it is no wonder that they should in part use the same output channels.

Other commentators, although agreeing in principle, point out some more difficulties. The strict temporal order of signals necessary to build up a travelling wave does not seem compatible with the scatter of signals in time and space that is to be expected in the rather disorderly system of afferent mossy fibers (**Lidierth, Bjaalie & Brodal**). To this we could perhaps reply that the travelling wave, evoked by a very large number of afferent fibers and carried by an even larger number of parallel fibers, is a statistical phenomenon which may be relevant even when there is randomness in the system it involves. On the output side, there is a discrepancy between the time scales of some phenomena which are learned in a process involving the cerebellum and the much shorter times that could be generated by conduction, or even by travelling waves within the cerebellar cortex (**Grethe & Thompson**). This implies that the cerebellar cortex, besides generating travelling waves, is involved in behavior in ways as yet unknown and different from the functions we assign to it.

More damaging to our theory (in spite of a generally favorable attitude) could be some observations which come from clinicians (**Topka & Dichgans**). While in our view the cerebellum compensates the passive ("parasitic") me-

chanical forces generated in the course of a movement by reducing the tension in the muscles which act in the same direction, **Topka & Dichgans** believe in muscles actively opposing the passive reaction forces. If this is the business of the cerebellum, after cerebellar lesions there should be an overall diminution of muscular force, and this does indeed seem to be the case. Our interpretation of the cerebellum would lead us to expect the contrary effect, but of course we know very well that cerebellar patients are not spastic. Moreover, according to our model we would expect cerebellar malfunction to affect the later parts of the complex agonist-antagonist-agonist succession, not the initial agonist burst, which these commentators find reduced in magnitude and shifted in time. An explanation of these discrepancies will have to wait for a more complete understanding of the balance between excitation and inhibition in the organs of motor control.

Some comments make additions to our story without detracting from it in any way. In **Morasso & Sanguineti's** commentary we admire the elegance and theoretical rigor which our ideas acquire in their hands, making them more palatable both to experimentalists and modelers. **McCollum** draws from her long experience in the physics and physiology of movements when she describes how the cerebellum singles out physically viable movements from the universe of all possible movements. In this we hear echoes of the Feynman path integral which is invoked in the **Kadar et al.** commentary on theoretical grounds.

**Bjaalie & Brodal** present a remarkable finding from their own research. In the projection of cerebral cortical body maps onto the pons and from there onto the cerebellar cortex, the well known distortions of the homunculus (e.g., over-representation of the distal extremities) are eliminated. The cerebellar maps are metrically correct where the cerebral maps are only topologically correct, just as the cerebellar histology seems to keep distances invariant where the cerebral cortex only preserves neighborhood relations. This observation, years ago, had been the starting point for our interpretation of the cerebellum as a timing organ (**Braitenberg & Atwood 1958**).

Finally, if anybody wants experimental confirmation of our "speculations" and does not accept Heck's experiments as such (because they were performed on excised cerebellar slices), the commentary by **Trillenberg & Wessel** should satisfy them. Using the method of functional magnetic resonance imaging of the cerebellum on human subjects, one finds evidence of active "beams" as well as "sagittal zones" and even "mosaic patterns" accompanying voluntary movements.

## R2. "No"

The denigrators of our theory present different arguments, more or less devastating, more or less incontrovertible.

**Schwarz**, if we read him correctly, bases his argument on a misunderstanding. It is not the precisely timed input that excites the Purkinje cell, but the height of the travelling wave. Since the crest of the wave is fairly broad, at least 0.5 mm, and broadened even by scatter in the input, the width of the Purkinje cell dendritic tree (varying between 0.001 and 0.035 mm in different animals) is relatively unimportant. Even if we think of delay lines and precise timing, it is not so much the width of the tree that counts as the distance between neighboring trees. Once this misunderstanding is

cleared up, the other points in this commentary are also weakened. Schwarz has doubts about how sequences in the input, filtered through the low-pass filter of the Purkinje cell EPSP, could produce any temporal precision in the output sequence (remember that in our view it is the relative timing of activity in different Purkinje cells along the beam that makes the “sequence out”). This seems rather like doubting that two trains cannot arrive at the station at the same time, or at slightly different times, because they are too long.

**Bower's** commentary attacks the roots of our reasoning. It is our conviction that the system of parallel fibers embodies the main secret of cerebellar function. Bower prefers to assign to the parallel fibers a rather ancillary role and produces physiological evidence for it. More fundamentally, we believe that the anatomy of the grey substance – or rather, the statistics of the synapses there – is the safest evidence on which to base a computer-like scheme of neural information handling. He denies the importance of three times ten to the twelfth synapses between parallel fibers and Purkinje cells, the most numerous in the cerebellum. His conviction is based on physiological evidence implying that the synapses between the ascending axons of granular cells (before their bifurcation) and the Purkinje cell are much more powerful than the more numerous synapses on the parallel fibers. Here we want to point out that there could hardly be any such synapses in the case of ascending axons bifurcating at the lowest level in the molecular layer. We surmise that the failure to activate Purkinje cells through parallel fibers is due to the inadequacy of static stimuli. Bower indicates that he has tried moving stimuli as well, without success. Luckily, there is a loophole through which a rehabilitation of parallel fibers may eventually become possible: Bower suggests that they may provide “contextual information” as a background for the real signals, which are carried by the ascending axons. What we do not know is how important the contextual information is compared to the real signals, and what context really means in the context in which the cerebellum operates.

We quite agree with the first statement in **Jäger & De Schutter's** commentary, namely, that our reasoning is based on neuroanatomy. Anatomy, like astronomy, provides indisputable facts no human hand has interfered with, and strongly constrains the choice of functional models, especially if they are to explain structural features which otherwise remain unexplained (like the geometry of the molecular layer). Of course, the inferences we draw from neuroanatomy must be checked against neurophysiology, and we tried to do so ourselves. Jäger & De Schutter are not convinced and point out some discrepancies which in their view cast doubt on our theory. In our scheme, they say, very few patterns of mossy fiber activation would produce significant effects. This is correct, and may actually be the point of the neuronal circuitry in the molecular layer, which selects for significant patterns and rejects noise (as most information handling machines do). They also suggest that we did not discover the role of inhibition, presumably because inhibitory fibers were cut off in our slice preparations. But then they point out that the inhibitory neurons do not contact only distant Purkinje cells, but also the ones in their immediate vicinity, through short fibers that should not have been severed in our slices. Finally, using arguments akin to those expressed in the commentary by

**Schwarz, Jäger & De Schutter** reject the idea of Purkinje cells as coincidence detectors. With the more macroscopic pattern of excitation which we call tidal wave, coincidence detection with precision in the millisecond range is not the main point, nor is scatter in the timing of spikes in individual Purkinje cells.

The experience of **Poppelle & Bosco** is in mapping peripheral input onto the surface of the cerebellum. They review their results in the light of our theory and find that to make the model fit the data, the model would have to be revised. The projection patterns of spinal afferents are, to say the least, complex and show only sketchily the somatotopic organization needed to transform movement through the body into continuous movement of afferent excitation through the cerebellar cortex. Our reply is that the space-time sequence along the beam may represent a trajectory through the body where there is unbroken somatotopy of either spinal afferents or corticocerebellar projections. But it may also represent any combination of input from lower or higher centers where the mapping is patchy. Such an apparently haphazard sequence of disparate elements could easily represent a meaningful event in the body, given the impenetrable complexity of mechanical interactions and neurological control which any movement entails. “A muscle in one part of the body can affect just about any other part,” writes **McCollum**, and “motor performance is even more easily represented in a non-neighbor-preserving way.”

The gist of **Garwicz & Andersson's** commentary is similar to that of **Poppelle & Bosco**, as is the evidence which supports their criticism. They, too, seem to have overlooked our statement about inputs to a beam which in general represent something much more complicated than a simple section through a somatotopic map. If waves travelling through the body were the only relevant input to the cerebellum (in some cases, in the form of mechanical shock waves involving the muscles and the skeleton, they may actually play a role), lack of somatotopy would surely make our theory collapse. But this is not what we think. More relevant objections are presented by Garwicz and Andersson based on the shortness of the beams in smaller cerebella, which would only allow for sequences of a very short duration. We can only surmise that shorter times may be relevant for smaller animals. Another objection actually sounds more like a confirmation of one of our basic points, namely the effectiveness of the parallel-fiber-Purkinje-cell synapse. Garwicz & Andersson have experimental evidence of a strong excitatory influence of parallel fibers on Purkinje cells situated at some distance from the point of entry of a mossy fiber, contradicting a tenet forcefully put forward by **Bower** in his commentary. However, when they take this finding as evidence that the tidal wave is not necessary, we must reply: it may not be necessary, but it certainly makes the influence on the Purkinje cell much stronger.

### R3. “It could be otherwise”

**Arbib & Spoelstra** develop a scheme that seems orthogonal to ours. Whereas we consider interactions in the cortical plane, their model relies on the point to point projections between the cerebellar cortex and the cerebellar nuclei, with “microzones” in this projection acting as functional units. These somehow influence the activity of another set of (cerebello-)cortical-subcortical units, the cerebello-

reticular loops that are capable of sustained reverberatory activity, and provide the output to the motor system. There is provision for learning in this model, notably at the parallel fiber–Purkinje cell synapse. Parallel fibers are given the role of coordinators of the activity of various motor units. The model by Arbib and Spoelstra is explicit enough even if our description here is quite compressed. (The reader is invited to consult the original papers by Arbib & Spoelstra to decide whether he finds it convincing.)

For **Miall** the cerebellum is a predictor of sensory consequences of motor acts. This is an appealing concept which brings the cerebellum closer to the sensory end of the nervous system (a trendy idea) without denying its importance in the motor context. Prediction is a term that could of course easily fit into our scheme (a travelling wave, once started, predicts the future of the development for which it stands), but Miall warns the reader that neural activity could move along preordained grooves even if it is not geometrically channelled by fiber bundles.

**MacKay's** reasoning is not orthogonal but clearly opposite to ours. Where we find comfort in temporal order, he sees synchronization as the solution. It is not clear whether this difference between us is more than a difference of taste, for some of the images he uses are quite close to ours. That “P-cells will respond best to a dynamic event” is actually our main point, and that they do so after transformation of sequential into synchronous signals is also part of our model. MacKay proposes mechanisms for the synchronization of movements (whether you really want to synchronize the action in different joints is another question) which invoke parts of the brain not considered by us, such as the thalamic reticular nucleus which resets (by inhibition) the system of thalamocortical neurons. Climbing fibers are assigned a similar synchronizing function. Hence the points MacKay makes are testable experimentally.

The commentary of **Dufossé et al.** takes the reader outside the narrow field of intracerebellar neuronal mechanisms to which most of the other comments were confined. The topic is cerebro-cerebellar interaction, learning, and error signals involved in it. The tendency is to assign much of the specificity to learning and little to inborn wiring, that is, much to large scale interaction and little to computation in the grey substance. One would like to understand better what goes on in detail when the cerebellum (in concert with the cerebrum) is involved in “mental training for sport exercise” or in the “planning of sequential movements.”

Last, the theoreticians **Mechsner & Palm** feel uneasy about any model that would assign to the cerebellum an all too rigid input-output transformation; they prefer to rely on their intuition about smooth and flexible movement control. In this, unwittingly, they are in agreement with one of the central points of our model, which is about lifelong learning in the parallel-fibers-Purkinje cell synapses, with the idea of achieving what Eccles called “smoothing” motor behavior. In the rest of their commentary they stay close to the models proposed by Marr and Albus, without, however, sharing with us the details of the “comprehensive, unconstrained, and convincing theory of cerebellar function (Mechsner 1996)” that they announce in their commentary. One of the points they raise, taken from Marr (1969), is that the striking geometry of the molecular layer does not necessarily imply timing, but can be understood as a device maximizing convergence in the parallel fibers-Purkinje cell system. This is not convincing, since the same degree of

convergence could be achieved even if the dendritic trees of Purkinje cells were intertwined like those of pyramidal cells in the cerebral cortex, and even if their afferent fibers were not parallel.

As things stand now, the author of the ultimate theory of the cerebellum will have to choose among sets of incompatible experimental data, digest the physics and physiology of movement that is beginning to emerge in its full complexity, apply neural network theory, and harmonize the role of the cerebellum with that of other equally splendid, equally mysterious parts of the brain. That theory could well be made the target of another round of commentaries in this journal.

#### R4. Our own commentary

On the whole, the interaction with our commentators has not shaken our belief in what we wrote. There are some difficulties which we see as clearly as our commentators do, but few that a further elaboration of our theory could not overcome. Two points remain a mystery. (1) Where does the high spike rate in Purkinje cells come from? (2) Why are Purkinje cell dendritic trees so flat? Both facts could be more easily explained by invoking a single spike, high temporal precision scheme, as in older versions of our theory. But before we revert to that, we will explore whether the two ideas could perhaps be combined, providing statistical information as in the tidal wave and single spike information. Both are known to operate in the nervous system, sometimes in close connection.

#### References

Letters “a” and “r” appearing before authors’ initials refer to target article and response, respectively.

- Abbott, L. F. & Blum, K. I. (1996) Functional-significance of long-term potentiation for sequence learning and prediction. *Cerebral Cortex* 6:406–16. [RCM]
- Abeles, M. (1990) *Corticonics*. Cambridge University Press. [CS]
- Adrian, E. D. (1943) Afferent areas in the cerebellum connected with the limbs. *Brain* 66:289–315. [aVB, REP]
- Akshoomoff, N. A., Courchesne, E. & Townsend, J. (in press) The role of the cerebellum in attention. In: *The cerebellum and cognition*, ed. J. D. Schmahmann. Academic Press. [EC]
- Albus, J. A. (1971) A theory of cerebellar function. *Mathematical Biosciences* 10:25–61. [aVB, FM, MGP]
- Allen, G., Buxton, R. B., Wong, E. C. & Courchesne, E. (1997) Attentional activation of the cerebellum independent of motor involvement. *Science* 275:1940–43. [EC]
- Almeida, G. L., Hong, D. A., Corcos, D. & Gottlieb, G. L. (1995) Organizing principles for voluntary movement: Extending single-joint rules. *Journal of Neurophysiology* 74:1474–81. [HT]
- Andersen, B. B., Korbo, L. & Pakkenberg, B. (1992) A quantitative study of the human cerebellum with unbiased stereological techniques. *Journal of Comparative Neurology* 326:549–60. [aVB]
- Andersson, G. & Eriksson, L. (1981) Spinal, trigeminal and cortical climbing fiber paths to the lateral vermis of the cerebellar anterior lobe in the cat. *Experimental Brain Research* 44:71–81. [aVB]
- Andersson, G. & Nyquist, J. (1983) Origin and sagittal termination areas of cerebrocerebellar climbing fiber paths in the cat. *Journal of Physiology* 337:257–85. [aVB]
- Andersson, G., Ekerot, C.-F., Oscarsson, O. & Schouenborg, J. (1987) Convergence of afferent paths to olivo-cerebellar complexes. In: *Cerebellum and neuronal plasticity*, ed. M. Glickstein, C. Yeo & J. Stein. Plenum. [aVB, MG]
- Arbib, M. A., Boylls, C. C. & Dev, P. (1974) Neural models of spatial perception and the control of movement. In: *Kybernetik und Bionik/Cybernetics*. R. Oldenbourg. [MAA]

- Ariëns Kappers, C. U., Huber, G. C. & Crosby, E. C. (1936) *The comparative anatomy of the nervous system of vertebrates including man*, vol. 1. Macmillan. [aVB]
- Baranyi, A. & Feher, O. (1978) Conditioned changes of synaptic transmission in the motor cortex of the cat. *Experimental Brain Research* 33:283–98. [MD]
- Barbour, B. (1993) Synaptic currents evoked in Purkinje cells by stimulating individual granule cells. *Neuron* 11:759–69. [RJH, CS, PDR]
- Bastian, A. J., Martin, T. A., Keating, J. G. & Thach, W. T. (1996) Cerebellar ataxia: Abnormal control of interaction torques across multiple joints. *Journal of Neurophysiology* 76:492–509. [HT, WAM]
- Bastian, A. J., Mueller, M. J., Martin, T. A., Keating, J. G. & Thach, W. T. (1994) Control of interaction torques during reaching in normal and cerebellar patients. *Society for Neurosciences Abstracts* 408(5). [MAA]
- Bell, C., Bodznick, D., Montgomery, J. & Bastian, J. (in press) The generation and subtraction of sensory expectations within cerebellum-like structures. *Brain, Behavior and Evolution*. [RCM]
- Bernston, G. G. & Scumacher, K. M. (1980) Effects of cerebellar lesions on activity, social interactions, and other motivated behaviors in the rat. *Journal of Comparative and Physiological Psychology* 94(4):706–17. [EC]
- Bishop, G. A. (1993) An analysis of HRP-filled basket cell axons in the cat's cerebellum: 1. Morphometry and configuration. *Anatomy and Embryology* 188:287–97. [aVB]
- Bizzi, E., Accornero, N., Chapple, W. & Hogan, N. (1982) Arm trajectory formation in monkeys. *Experimental Brain Research* 46:139–43. [aVB]
- (1984) Posture control and trajectory formation during arm movement. *Journal of Neuroscience* 4:2738–44. [aVB]
- Bizzi, E., Chapple, W. & Hogan, N. (1982) Mechanical properties of muscle. *Trends in Neuroscience* 5:395–98. [aVB]
- Bizzi, E., Mussa-Ivaldi, F. A. & Hogan, N. (1986) Regulation of multi-joint arm posture and movement. *Progress in Brain Research* 64:345–51. [aVB]
- Bizzi, E., Polit, A. & Morasso, P. (1976) Mechanisms underlying achievement of final head position. *Journal of Neurophysiology* 39:435–44. [aVB]
- Bjralle, J. G., Diggle, P. J., Nikundiwe, A., Karagülle, T. & Brodal, P. (1991) Spatial segregation between populations of ponto-cerebellar neurons: Statistical analysis of multivariate spatial interactions. *Anatomical Record* 231:510–23. [JGB]
- Bloedel, J. R., Gregory, R. S. & Martin, S. H. (1972) Action of interneurons and axon collaterals in cerebellar cortex of a primate. *Journal of Neurophysiology* 35:847–63. [DJ]
- Bodznick, D. & Boord, R. L. (1986) Electroreception in chondrichthyes: Central anatomy and physiology. In: *Electroreception*, ed. T. Bullock & W. Heiligenberg. Wiley. [MGP]
- Bosco, G. & Poppele, R. E. (1996) Temporal features of directional tuning by spinocerebellar neurons: Relation to limb geometry. *Journal of Neurophysiology* 75:1647–58. [WAM]
- Bosco, G., Rankin, A. & Poppele, R. E. (1996) A representation of passive hindlimb postures in cat spinocerebellar activity. *Journal of Neurophysiology* 76:715–26. [REP]
- Bower, J. M. (in press) Is the cerebellum sensory for motor's sake, or motor for sensory's sake: The view from the whiskers of the rat. *Progress in Brain Research*. [JMB]
- Bower, J. M. & Kassel, J. (1990) Variability in tactile projection patterns to the cerebellar folia crus IIA of the Norway rat. *Journal of Comparative Neurology* 302:768–78. [EC]
- Bower, J. M. & Woolston, D. C. (1983) Congruence of spatial organization of tactile projections to granule cell and Purkinje cell layers of cerebellar hemispheres of the albino rat: Vertical organization of cerebellar cortex. *Journal of Neurophysiology* 49:745–66. [aVB, JMB, JSG, DJ, FM]
- Boylls, C. C. (1978) Prolonged alterations of muscle activity induced in locomoting preamamillary cats by microstimulation of the inferior olive. *Brain Research* 159:445–50. [MAA]
- Braitenberg, V. (1961) Functional interpretation of cerebellar histology. *Nature* 190(4775): 539–640. [arVB, JSG]
- (1965) A note on the control of voluntary movements. In: *Cybernetics of neural processes*, ed. E. R. Caianiello. Rome: Consiglio Nazionale delle Ricerche. [aVB]
- (1983) The cerebellum revisited. *Journal of Theoretical Neurobiology* 2:237–41. [aVB]
- (1987) The cerebellum and the physics of movement: Some speculations. In: *Cerebellum and neuronal plasticity*, ed. M. Glickstein, C. Yeo & J. Stein. Plenum. [aVB]
- (1993) The cerebellar network: Attempt at a formalization of its structure. *Network* 4:11–17. [aVB]
- Braitenberg, V. & Atwood, R. P. (1958) Morphological observations on the cerebellar cortex. *Journal of Comparative Neurology* 109:1–33. [arVB, JSG]
- Braitenberg, V. & Onesto, N. (1962) The cerebellar cortex as a timing organ. Discussion of an hypothesis. In: *Proceedings of the First International Conference on Medical Cybernetics*, Naples. Giannini. [aVB]
- Braitenberg, V. & Preissl, H. (1992) Why is the output of the cerebellum inhibitory? *Behavioral Brain Science* 15:715–17. [aVB]
- Braitenberg, V. & Schüz, A. (1991) *Anatomy of the cortex*. Springer-Verlag. [aVB]
- Brand, S., Dahl, A.-L. & Mugnaini, E. (1976) The length of parallel fibers in the cat cerebellar cortex: An experimental light and microscopic study. *Experimental Brain Research* 26:39–58. [aVB]
- Brodal, A. (1981) *Neurological anatomy in relation to clinical medicine*. Oxford University Press. [aVB]
- Brodal, P. & Bjaalie, J. G. (1992) Organization of the pontine nuclei. *Neuroscience Research* 13:83–118. [JGB, CS]
- Brooks, V. B. & Thach, W. T. (1981) Cerebellar control of posture and movement. In: *Handbook of physiology: sect. 1. The nervous system: vol. 2, part 2*, ed. V. B. Brooks. American Physiological Society. [aVB]
- Campbell, N. C., Ekerot, C.-F., Hesslow, G. & Oscarsson, O. (1983) Dendritic plateau potentials evoked in Purkinje cells by parallel fiber volleys in the cat. *Journal of Physiology* 340:209–223. [aVB, RJH]
- Castelfranco, A. M., Robertson, L. T. & McCollum, G. (1993) Detail, proportion, and foci among face receptive fields of climbing fiber responses in the cat cerebellum. *Somatosensory and Motor Research* 11:27–46. [GM]
- Chauvet, G. A. (1986) Habituation rules for a theory of the cerebellar cortex. *Biological Cybernetics* 55:201–9. [GAC]
- (1993a) Non-locality in biological systems results from hierarchy: Application to the nervous system. *Journal of Mathematical Biology* 31:475–86. [GAC]
- (1993b) Hierarchical functional organization of formal biological systems: A dynamical approach (parts 1 and 3). *Philosophical Transactions of the Royal Society B* 339:425–81. [GAC]
- (1995) On associative motor learning by the cerebellar cortex: From Purkinje unit to network with variational learning rules. *Mathematical Biosciences* 126:41–79. [GAC]
- (1996) *Theoretical systems in biology: Hierarchical and functional integration*, vol. 3. Pergamon. [GAC]
- Chauvet, P. & Chauvet, G. A. (1995) Mathematical conditions for adaptive control in Marr's model of the sensorimotor system. *Neural Networks* 8(5):693–706. [GAC]
- Clark, B. & Häusser, M. (1995) Synaptic inhibition of cerebellar Purkinje cells by single interneurons. *Society for Neuroscience Abstracts* 21:595. [DJ]
- Clark, R. E. & Lavond, D. G. (1993) Reversible lesions of the red nucleus during acquisition and retention of a classically conditioned behavior in rabbits. *Behavioral Neuroscience* 107:264–70. [JSG]
- Clark, R. E., Zhang, A. A. & Lavond, D. G. (1992) Reversible lesions of the cerebellar interpositus nucleus during acquisition and retention of a classically conditioned behavior. *Behavioral Neuroscience* 106:879–88. [JSG]
- Coenen, O. J. M. D. & Sejnowski, T. J. (1996) Learning to make predictions in the cerebellum may explain the anticipatory modulation of the vestibulo-ocular reflex (VOR) gain with vergence. *Proceedings of the Third Joint Symposium on Neural Computation*, Institute of Neural Computation, University of California, San Diego. [EC]
- Cohen, L. & Wu, J. (1990). One neuron, many units. *Nature* 346:108–9. [aVB]
- Colin, F., Manil, J. & Desclin, J. C. (1980) The olivocerebellar system. Delayed and slow inhibitory effect: Overlooked salient feature of the cerebellar climbing fibers. *Brain Research* 187:3–27. [aVB]
- Combs, C. M. (1954) Electro-anatomical study of cerebellar localization. Stimulation of various afferents. *Journal of Neurophysiology* 17:123–43. [aVB]
- Courchesne, E., Townsend, J., Akshoomoff, N. A., Saitoh, O., Yeung-Courchesne, R., Lincoln, A. J., James, H. E., Haas, R. H., Schreibman, L. & Lau, L. (1994) Impairment in shifting attention in autistic and cerebellar patients. *Behavioral Neuroscience* 108(5):848–65. [EC]
- Crépel, F. (1974) Excitatory and inhibitory processes acting upon cerebellar Purkinje cells during maturation in the rat: Influence of hypothyroidism. *Experimental Brain Research* 20:403–20. [aVB]
- Crépel, F., Dhanjal, S. S. & Garthwaite, J. (1981) Morphological and electrophysiological characteristics of rat cerebellar slices maintained in vitro. *Journal of Physiology* 316:127–38. [JSG]
- Darlot, C. (1993) The cerebellum as a predictor of neural messages: 1. The stable estimator hypothesis. *Neuroscience* 56:617–46. [RCM]
- De Schutter, E. (1994) Modeling the cerebellar Purkinje cell: Experiments in computo. In: *The self-organizing brain: From growth cones to functional networks*, ed. J. van Pelt, M. A. Corner, H. B. M. Uylings & F. H. Lopes da Silva. *Progress in Brain Research* 102:427–41. [DJ]
- De Schutter, E. & Bower, J. M. (1994a) Responses of cerebellar Purkinje cells are independent of the dendritic location of granule cell synaptic inputs. *Proceedings of the National Academy of Science (USA)* 91:4736–40. [JMB]
- (1994b) An active membrane model of the cerebellar Purkinje cell:

2. Simulation of synaptic responses. *Journal of Neurophysiology* 71:401–19. [DJ]
- Deacon, T. W. (1990) Rethinking mammalian brain evolution. *American Zoologist* 30:629–706. [MGP]
- Desclin, J. C. & Colin, F. (1980) The olivocerebellar system: 2. Some ultrastructural correlates of inferior olive destruction in the rat. *Brain Research* 187:29–46. [aVB]
- Dichgans, J. & Diener, H. C. (1984) Clinical evidence for functional compartmentalization of the cerebellum. In: *Cerebellar functions*, ed. J. R. Bloedel, J. Dichgans & W. Precht. Springer Verlag. [aVB]
- Diener, H. C., Hore, J., Ivry, R. & Dichgans, J. (1993) Cerebellar dysfunction of movement and perception. *Canadian Journal of Neurological Sciences* 20:S62–69. [RCM]
- Dietrichs, E. & Walberg, F. (1989) Direct bidirectional connections between the inferior olive and the cerebellar nuclei. In: *The olivocerebellar system in motor control*, ed. P. Strata. Springer-Verlag. [aVB]
- Dow, R. S. (1949) Action potentials of cerebellar cortex in response to local electrical stimulation. *Journal of Neurophysiology* 12:245–56. [aVB]
- Dufossé, M., Ito, M. & Miyashita, Y. (1977) Functional localization in the rabbit's cerebellar flocculus determined in relationship with eye movements. *Neuroscience Letters* 5:273–77. [MD]
- Eccles, J. C. (1973) The cerebellum as a computer: Patterns in space and time. *Journal of Physiology* 229:1–32. [aVB, MAA]
- Eccles, J. C., Ito, M. & Szentágothai, J. (1967) *The cerebellum as a neuronal machine*. Springer-Verlag. [aVB, PDR]
- Eccles, J. C., Llinás, R. & Sasaki, K. (1966) Parallel fibre stimulation and the responses induced thereby in the Purkinje cells of the cerebellum. *Experimental Brain Research* 1:17–29. [aVB, JMB]
- Eccles, J. C., Sabah, N. H., Schmidt, R. F. & Taborikova, H. (1972a) Integration of Purkinje cells of mossy and climbing fiber inputs from cutaneous mechanoreceptors. *Experimental Brain Research* 15:498–520. [JMB]
- (1972b) Cutaneous mechanoreceptors influencing impulse discharges in cerebellar cortex: 1. In mossy fibres. *Experimental Brain Research* 15:245–60. [ML]
- Eccles, J. C., Sasaki, K. & Strata, P. (1967b) A comparison of the inhibitory actions of Golgi cells and of basket cells. *Experimental Brain Research* 3:81–94. [aVB]
- Ekerot, C.-F. & Larson, B. (1980) Termination in overlapping sagittal zones in cerebellar anterior lobe of mossy fiber paths activated from dorsal funiculus. *Experimental Brain Research* 38:163–72. [aVB, MG]
- Ekerot, C.-F. & Oscarsson, O. (1981) Prolonged depolarization elicited in Purkinje cell dendrites by climbing fiber impulses in the cat. *Journal of Physiology* 318:207–21. [aVB]
- Ellerman, J. M., Flament, D., Kim, S.-G., Fu, Q.-G., Merkle, G., Ebner, T. J. & Ugurbil, K. (1994) Spatial pattern of functional activation of the cerebellum investigated using high field (4T) MRI/NMR. *Biomedicine* 7:63–68. [PT]
- Ermentrout, B. & Cowan, J. D. (1979) Mathematical theory of visual hallucination patterns. *Biological Cybernetics* 34:137–50. [PDR]
- Evarts, E. V. (1972) Pre- and postcentral neuronal discharge in relation to learned movement. In: *Corticothalamic projections and sensorimotor activities*, ed. T. Frigyesi, E. Rinvik & M. D. Yahr. Raven. [aVB]
- Feldman, A. G. (1966) Functional tuning of the nervous system during control of movement or maintenance of a steady posture: 3. Mechanographic analysis of the execution by man of the simplest motor task. *Biophysics* 11:766–75. [aVB]
- (1974a) Change of muscle length due to shift of the equilibrium point of the muscle-load system. *Biofizika* 19:534–38. [aVB]
- (1974b) Control of muscle length. *Biofizika* 19:749–51. [aVB]
- (1986) Once more on the equilibrium-point hypothesis (Lambda model) for motor control. *Journal of Motor Behavior* 18:17–54. [aVB]
- Feyerabend, P. (1976) *Wider den Methodenzwang*. Suhrkamp. [FM]
- Feynman, R. P. & Hibbs, A. R. (1965) *Quantum mechanics and path integrals*. McGraw-Hill. [EEK, RES]
- Fortier, P. A., Kalaska, J. F. & Smith, A. M. (1989) Cerebellar neuronal activity related to whole-arm reaching movements in the monkey. *Journal of Neurophysiology* 62:198–211. [aVB]
- Fortier, P. A., Smith, A. M. & Kalaska, J. F. (1993) Comparison of cerebellar and motor cortex activity during reaching: Directional tuning and response variability. *Journal of Neurophysiology* 69:1136–49. [MD]
- Fox, P. T., Raichle, M. E. & Thach, W. T. (1985) Functional mapping of the human cerebellum with positron emission tomography. *Proceedings of the National Academy of Science (USA)* 82:7462–66. [PT]
- Gähwiler, B. H. & Llano, I. (1989) Sodium and potassium conductances in somatic membranes of rat Purkinje cells from organotypic cerebellar cultures. *Journal of Physiology (London)* 417:105–22. [aVB]
- Gao, J. H., Parsons, L. M., Bower, J. M., Xiong, J., Li, J. & Fox, P. T. (1996) Cerebellum implicated in sensory acquisition and discrimination rather than motor control. *Science* 272:545–47. [RCM, MGP]
- Gardner-Medwin, A. R. (1971) A supernormal period after an action potential in parallel fibres of the cerebellum. *Journal of Physiology (London)* 216:59P – 60P. [ML]
- Garwicz, M. & Andersson, G. (1922) Spread of synaptic activity along parallel fibers in cat cerebellar anterior lobe. *Experimental Brain Research* 88:615–22. [aVB, MG]
- Gellman, R., Gibson, A. R. & Houk, J. C. (1985) Inferior olivary neurons in the awake cat: Detection of contact and passive body displacement. *Journal of Neurophysiology* 54:40–60. [aVB]
- Gellman, R., Houk, J. C. & Gibson, A. R. (1983) Somatosensory properties of the inferior olive of the cat. *Journal of Comparative Neurology* 215:228–43. [aVB]
- Georgopoulos, A., Kalaska, J. F., Caminiti, R. & Massey, J. T. (1982) On the relations between the direction of two-dimensional arm movements and cell discharge in primate motor cortex. *Journal of Neuroscience* 2:1527–37. [REP]
- Georgopoulos, A. P., Kettner, R. E. & Schwartz, A. B. (1988) Primate motor cortex and free arm movements to visual targets in three-dimensional space: 2. Coding of the direction of movement by a neuronal population. *Journal of Neuroscience* 8:2928–37. [aVB]
- Georgopoulos, A. P., Schwartz, A. B. & Kettner, R. E. (1986) Neuronal population coding of movement direction. *Science* 233:1416–19. [aVB]
- Gibson, A. R. & Gellman, R. S. (1987) Functional implications of inferior olivary response properties. In: *Cerebellum and neuronal plasticity*, ed. M. Glickstein, C. Yeo & J. Stein. Plenum. [aVB]
- Glickstein, M. (1987) Structure and function of the cerebellum: A historical introduction to some current problems. In: *Cerebellum and neuronal plasticity*, ed. M. Glickstein, J. Stein & C. Yeo. Plenum Press. [aVB]
- Gonzalez, L., Shumway, C., Morissette, J. & Bower, J. M. (1933) Developmental plasticity in cerebellar tactile maps: Fractured maps retain a fractured organization. *Journal of Comparative Neurology* 332:487–98. [aVB, DJ]
- Gray, C., Percivalle, V. & Poppele, R. (1993) Sensory responses to passive hindlimb joint rotation in the cerebellar cortex of the cat. *Brain Research* 622:280–84. [REP]
- Gray, E. G. (1961) The granule cells, mossy synapses and Purkinje spine synapses of the cerebellum: Light and electron microscope observations. *Journal of Anatomy* 95:345–56. [aVB]
- Hallett, M. & Massaquoi, S. G. (1993) Physiologic studies of dysmetria in patients with cerebellar deficits. *Canadian Journal of the Neurological Sciences* 3(suppl):S83–92. [HT]
- Hallett, M., Pascual-Leone, A. & Topka, H., Ebner, T. J. & Wise, S. P. (1996) Adaptation and skill learning. Evidence for different neural substrates. In: *Acquisition of motor behavior in vertebrates*, ed. J. R. Bloedel. MIT Press. [HT]
- Hallett, M., Shahani, B. & Young, R. R. (1995) EMG analysis in patients with cerebellar deficits. *Journal of Neurology, Neurosurgery and Psychiatry* 38:1163–69. [HT]
- Hannaford, B. & Stark, L. (1987) Late agonist activation burst (PC) required for optimal head movement: A simulation study. *Biological Cybernetics* 57:321–30. [aVB]
- Harvey, R. J. & Napper, R. M. A. (1988) Quantitative study of granular and Purkinje cells in the cerebellar cortex of the rat. *Journal of Comparative Neurology* 274:151–57. [aVB]
- (1991) Quantitative studies on the mammalian cerebellum. *Progress in Neurobiology* 36:437–63. [RJH]
- Harvey, R. J., Porter, R. & Rawson, J. A. (1977) The natural discharge of Purkinje cells in paravermal regions of lobules V and VI of the monkey's cerebellum. *Journal of Physiology* 271:515–36. [aVB]
- Hawkes, R. & Leclerc, N. (1987) Antigenic map of the rat cerebellar cortex: The distribution of parasagittal bands as revealed by monoclonal anti-Purkinje cell antibody map Q113. *Journal of Comparative Neurology* 256:29–41. [RJH]
- Heck, D. (1993) Rat cerebellar cortex in vitro responds specifically to moving stimuli. *Neuroscience Letters* 157:95–98. [aVB, JSG, DJ, ML, FM]
- (1995a) Sequential input to guinea pig cerebellar cortex in vitro strongly affects Purkinje cells via parallel fibers. *Naturwissenschaften* 82:201–3. [aVB, JSG]
- (1995b) Investigating dynamic aspects of brain function in slice preparations: Spatiotemporal stimulus patterns generated with an easy to build multi-electrode array. *Journal of Neuroscientific Method* 58:81–87. [aVB, JSG]
- (1995c) *Die Bedeutung Raum-Zeitlicher Dynamik für die Aktivität des Kleinhirnkortex und die Interpretation seiner Anatomie*. Hamburg: Verlag Dr. Kovac. [aVB]
- Hellwig, B., Schüz, A. & Aertsen, A. (1994) Synapses on axon collaterals of

- pyramidal cells are at random intervals: A Golgi study in the mouse cerebral cortex. *Biological Cybernetics* 71:1–13. [aVB]
- Hewer, R. L., Cooper, R. & Morgan, M. H. (1972) An investigation into the value of treating intention tremor by weighting the affected limb. *Brain* 95:579–90. [PT]
- Hockberger, P. E., Tseng, H. Y. & Connor, J. A. (1989) Fura-2 measurements of cultured rat Purkinje neurons show dendritic localisation of Ca<sup>2+</sup> influx. *Journal of Neuroscience* 9(7):2272–84. [aVB]
- Hogan, N. (1985) The mechanics of multi-joint posture and movement control. *Biological Cybernetics* 52:315–31. [aVB]
- Hollerbach, J. M. & Flash, T. (1982) Dynamic interactions between limb segments during planar arm movement. *Biological Cybernetics* 44:67–77. [aVB, HT]
- Holmes, G. (1922) The Croonian Lectures on the clinical symptoms of cerebellar disease and their interpretation (lecture 2). *Lancet* 1:1231–37. [PT]
- (1939) The cerebellum of man (Hughlings Jackson memorial lecture). *Brain* 62:1–30. [HT]
- Hore, J. & Flament, D. (1986) Evidence that a disordered servo-like mechanism contributes to tremor in movements during cerebellar dysfunction. *Journal of Neurophysiology* 56:123–36. [PT]
- Hore, J., Wild, B. & Diener, H. C. (1991) Cerebellar dysmetria at the elbow, wrist, and fingers. *Journal of Neurophysiology* 65:563–71. [aVB, HT]
- Horner, C. H. (1993) Plasticity of the dendritic spine. *Progress in Neurobiology* 41:281–321. [aVB]
- Houk, J. C. (1987) Model of the cerebellum as an array of adjustable pattern generators. In: *Cerebellum and neuronal plasticity*, ed. M. Glickstein & C. Yeo. Plenum. [FM]
- Houk, J. C., Buckingham, J. T. & Barto, A. G. (1996) Models of the cerebellum and motor learning. *Behavioral and Brain Sciences* 19:368–83. [MAA]
- Houk, J. C., Singh, S. P., Fisher, C. & Barto, A. G. (1990) An adaptive sensorimotor network inspired by the anatomy and physiology of the cerebellum. In: *Neural networks for control*, ed. W. T. Miller, R. S. Sutton & P. J. Werbos. MIT Press. [JSG]
- Hounsgaard, J. (1989) *Complex information processing in nerve cells*. University of Copenhagen. [aVB]
- Hounsgaard, J. & Midtgaard, J. (1988) Intrinsic determinants of firing pattern in Purkinje cells of the turtle cerebellum in vitro. *Journal of Physiology (London)* 402:731–49. [aVB]
- (1989) Dendrite processing in more ways than one. *Trends in Neuroscience* 12(9):313–15. [aVB]
- Inhoff, A. W., Diener, H. C., Rafal, R. D. & Ivry, R. (1989) The role of cerebellar structures in the execution of serial movements. *Brain* 112:565–81. [MD]
- Iriki, A., Pavlides, C., Keller, A. & Asanuma, H. (1992) Long-term potentiation in the motor cortex. *Science* 245:1385–87. [MD]
- Ito, M. (1984) *The cerebellum and neural control*. Raven Press. [MAA, GAC, JSG, EEK]
- Ito, M., Sakurai, M. & Tongroach, P. (1982) Climbing fiber induced depression of both mossy fiber responsiveness and glutamate sensitivity of cerebellar Purkinje-cells. *Journal of Physiology (London)* 324:113–34. [aVB]
- Ito, M. & Yoshida, M. (1964) The cerebellar-evoked monosynaptic inhibition of Deiters' neurons. *Experientia* 20:515–16. [aVB]
- (1966) The origin of cerebellar-induced inhibition of Dieters neurons: 2. Monosynaptic initiation of the inhibitory postsynaptic potentials. *Experimental Brain Research* 2:330–49. [aVB]
- Ito, M., Yoshida, M. & Obata, K. (1964) Monosynaptic inhibition of the intracerebellar nuclei induced from the cerebellar cortex. *Experientia* 20:575–76. [aVB]
- Ito, M., Yoshida, M., Obata, K., Kawai, N. & Udo, M. (1970) Inhibitory control of intracerebellar nuclei by the Purkinje cell axons. *Experimental Brain Research* 10:64–80. [aVB]
- Ivry, R. (1993) Cerebellar involvement in the explicit representation of temporal information. *Annals of the New York Academy of Sciences* 682:214–30. [JSG]
- Jaeger, D. & Bower, J. M. (1994) Prolonged responses in rat cerebellar Purkinje cells following activation of the granule cell layer: An intracellular in vitro and in vivo investigation. *Experimental Brain Research* 100:200–14. [CS]
- Jaeger, D., De Schutter, E. & Bower, J. M. (1997) The role of synaptic and voltage-gated currents in the control of Purkinje cell spiking: A modeling study. *Journal of Neuroscience* 17:91–106. [JMB, DJ]
- Jansen, J. & Brodal, A. (1940) Experimental studies on the intrinsic fibers of the cerebellum: 2. The corticonuclear projection in the rabbit and the monkey. *Journal of Comparative Neurology* 73:267–321. [aVB]
- Jeanerod, M., Arbib, M., Rizzolatti, G. & Sakata, H. (1995) Grasping objects: The cortical mechanisms of visuomotor transformation. *Trends in Neuroscience* 18:314–20. [PM]
- Jerison, H. J. (1973) Gross brain indices and the meaning of brain size. In: *Evolution of the brain and intelligence*, ed. anonymous. Academic Press. [aVB]
- Jibu, M. & Yasue, K. (1995) *Quantum brain dynamics and consciousness: An introduction*. Benjamins. [RES]
- Johnston, J. B. (1902a) The brain of Petromyzon. *Journal of Comparative Neurology* 7:2–82. [aVB]
- (1902b) An attempt to define the primitive functional divisions of the central nervous system. *Journal of Comparative Neurology* 7:87–106. [aVB]
- Kassel, J., Shambes, G. M. & Welker, W. (1984) Fractured cutaneous projections to the granule cell layer of the posterior cerebellar hemisphere of the domestic cat. *Journal of Comparative Neurology* 225:458–68. [aVB]
- Kawato, M., Furukawa, K. & Suzuki, R. (1987) A hierarchical neural network model for control of learning of voluntary movement. *Biological Cybernetics* 57:169–85. [MAA]
- Knöpfel, T., Vranesic, I., Staub, C. & Gähwiler, B. H. (1991) Climbing fibre responses in olivo-cerebellar slice cultures: 2. Dynamics of cytosolic calcium in Purkinje cells. *European Journal of Neuroscience* 3:343–48. [aVB]
- Konnerth, A., Llano, I. & Armstrong, C. M. (1990) Synaptic currents in cerebellar Purkinje cells. *Proceedings of the National Academy of Sciences USA* 87:2662–65. [aVB]
- Kornhuber, H. H. (1974) Cerebral cortex, cerebellum and basal ganglia: An introduction to their motor function. In: *The neurosciences: Third study program*, ed. F. O. Schmitt & F. G. Worden. MIT Press. [aVB]
- Kramer, E. E. (1970) *The nature and growth of modern mathematics*. Hawthorn. [RES]
- Krupa, D. J. & Thompson, R. F. (1995) Inactivation of the superior cerebellar peduncle blocks expression but not acquisition of the rabbit's classically conditioned eyeblink response. *Proceedings of the National Academy of Sciences (USA)* 92:5097–5101. [JSG]
- Krupa, D. J., Thompson, J. K. & Thompson, R. F. (1993) Localization of a memory trace in the mammalian brain. *Science* 260:989–91. [JSG]
- Krupa, D. J., Weng, J. & Thompson, R. F. (1996) Inactivation of brain-stem motor nuclei blocks expression but not acquisition of the rabbit's classically-conditioned eyeblink response. *Behavioral Neuroscience* 100:219–27. [JSG]
- Lanczos, C. (1970) *The variational principles of mechanics*. Dover. [RES]
- Larson-Prior, L. J., McCrimmon, D. R. & Slater, N. T. (1990) Slow excitatory amino acid receptor-mediated synaptic transmission in turtle cerebellar Purkinje cells. *Journal of Neurophysiology* 63:637–50. [CS]
- Le, T. H. & Hu, X. (1996) Involvement of the cerebellum in intramodality attention shifting. *NeuroImage* 3:S246. [EC]
- Leggio, M. G., Solida, A., Silveri, M. C., Gainotti, G. & Molinari, M. (1995) Verbal fluency impairment in patients with cerebellar lesions (part 2). *Society for Neuroscience Abstracts* 21:917. [MM]
- Leicht, R. & Schmidt, R. F. (1977) Somatotopic studies on the vermal cortex of the cerebellar anterior lobe of unanaesthetized cats. *Experimental Brain Research* 27:479–90. [aVB]
- Leicht, R., Rowe, M. J. & Schmidt, R. F. (1977) Mossy and climbing fiber inputs from cutaneous mechanoreceptors to cerebellar Purkinje cells in unanesthetized cats. *Experimental Brain Research* 27:459–77. [aVB]
- Leiner, H. C., Leiner, A. L. & Dow, R. S. (1993) Cognitive and language functions of the human cerebellum. *Trends in Neurosciences* 16:444–47. [RCM]
- Lemkey-Johnston, N. & Larramendi, L. M. H. (1968) Types and distribution of synapses upon basket and stellate cells of the mouse cerebellum: An electron microscopic study. *Journal of Comparative Neurology* 134:73–112. [aVB]
- Leranth, C. & Hámori, J. (1981) Quantitative electron microscope study of synaptic terminals to basket neurons in cerebellar cortex of rat. *Zeitschrift für Mikroskopisch Anatomische Forschung* 95:1–14. [aVB]
- Lestienne, R. (1996) Determination of the precision of spike timing in the visual cortex of anaesthetised cats. *Biological Cybernetics* 74:55–61. [CS]
- Llano, I., Marty, A., Armstrong, C. M. & Konnerth, A. (1991) Synaptic- and agonist-induced excitatory currents of Purkinje cells in rat cerebellar slices. *Journal of Physiology (London)* 434:183–213. [aVB]
- Llinás, R. (1982) Radial connectivity in the cerebellar cortex: A novel view regarding the functional organization of the molecular layer. In: *The cerebellum, new vistas*, ed. S. L. Palay & V. Chan-Palay. Springer-Verlag. [aVB, JSG]
- Llinás, R. & Sugimori, M. (1980a) Electrophysiological properties of in vitro Purkinje cell dendrites in mammalian cerebellar slices. *Journal of Physiology (London)* 305:197–213. [aVB]
- (1980b) Electrophysiological properties of in vitro Purkinje cell somata in mammalian cerebellar slices. *Journal of Physiology* 305:171–95. [CS]
- Llinás, R., Walton, K. & Hillman, D. E. (1975) Inferior olive: Its role in motor learning. *Science* 190:1230–31. [aVB]
- Lyngstad, K. A., Thompson, J. H., Bower, J. M. & Bjaalie, J. G. (1996)

- Somatosensory pathways to the cerebellum: Spatial organization of electrophysiologically identified corticopontine terminal fibers in the rat. *Society for Neuroscience Abstracts* 22:203. [JGB]
- MacKay, W. A. (1996) Cooperative structures for visually guided reach. *Canadian Journal of Physiology and Pharmacology* 74:463–68. [WAM]
- Mainen, Z. F. & Sejnowski, T. J. (1995) Reliability of spike timing in neocortical neurons. *Science* 268:1503–6. [CS]
- Manto, M., Jacquy, J., Hildebrand, J. & Godaux, E. (1995) Recovery of hypermetria after a cerebellar stroke occurs as a multistage process. *Annals of Neurology* 38:437–45. [PT]
- Marr, D. (1969) A theory of cerebellar cortex. *Journal of Physiology* 202:437–70. [aVB, FM, MGP]
- Mason, C. A. & Gregory, E. (1984) Postnatal maturation of cerebellar mossy and climbing fibers: Transient expression of dual features on single axons. *Journal of Neuroscience* 4:1715–35. [aVB]
- Massaquoi, S. G. & Hallett, M. (1996) Kinematics of initiating a two-joint arm movement in patients with cerebellar ataxia. *Canadian Journal of Neurological Sciences* 23:3–14. [HT]
- Matsushita, M., Tanami, T. & Yaginuma, H. (1984) Differential distribution of spinocerebellar fiber terminals within the lobules of the cerebellar anterior lobe in the cat: An anterograde WGA-HRP study. *Brain Research* 305:157–61. [REP]
- Mayhew, T. M. (1991) Accurate prediction of Purkinje cell number from cerebellar weight can be achieved with the fractionator. *Journal of Comparative Neurology* 308:162–68. [aVB]
- McCollum, G., Holroyd, C. & Castelfranco, A. M. (1995) Forms of early walking. *Journal of Theoretical Biology* 176:373–90. [GM]
- McIlwain, J. T. (1986) Point images in the visual system: New interest in old idea. *Trends in Neuroscience* 9:354–58. [GM]
- Mechsner, F. (1996) A new theory of cerebellar function. *Connection Science* 8(1):31–54. [FM]
- Meek, J. (1992) Why run parallel fibers parallel? Teleostean Purkinje cells as possible coincidence detectors, in a timing device subserving spatial coding of temporal differences. *Neuroscience* 48:249–83. [RJH, JM]
- (1992b) Comparative aspects of cerebellar organization: From mormyrids to mammals. *European Journal of Morphology* 30:37–51. [JM]
- Meek, J. & Nieuwenhuys, R. (1991) Palisade pattern of mormyrid Purkinje cells: A correlated light and electron microscopic study. *Journal of Comparative Neurology* 306:156–92. [JM]
- Meek, J., Hafmans, T. G. M., Maler, L. & Hawkes, R. (1992) The distribution of zebirin II in the gigantocerebellum of the mormyrid fish *Gnathonemus petersii* compared with other teleosts. *Journal of Comparative Neurology* 316:17–31. [JM]
- Merrill, E. G., Wall, P. D. & Yaksh, T. L. (1978) Properties of two unmyelinated fibre tracts of the central nervous system: Lateral Lissauer tract, and parallel fibres of the cerebellum. *Journal of Physiology (London)* 284:127–45. [ML]
- Meyer-Lohmann, J., Hore, J. & Brooks, V. B. (1977) Cerebellar participation in generation of prompt arm movements. *Journal of Neurophysiology* 40:1038–50. [HT]
- Miall, R. C. (1989) The storage of time intervals using oscillating neurons. *Neural Computation* 1:359–71. [RCM]
- (1993) Neural networks and the representation of time. *Psychologica Belgica* 33:255–69. [RCM]
- Miall, R. C. & Wolpert, D. M. (1996) Forward models for physiological motor control. *Neural Networks* 9:1265–79. [RCM]
- Miall, R. C., Weir, D. J., Wolpert, D. M. & Stein, J. F. (1993) Is the cerebellum a Smith Predictor? *Journal of Motor Behavior* 25:203–16. [RCM]
- Midtgaard, J. (1992) Stellate cell inhibition of Purkinje cells in the turtle cerebellum *in vitro*. *Journal of Physiology (London)* 457:355–67. [aVB]
- Midtgaard, J., Lasser-Ross, N. & Ross, W. N. (1993) Spatial distribution of Ca<sup>2+</sup> influx in turtle Purkinje cell dendrites *in vitro*: Role of a transient outward current. *Journal of Neurophysiology* 70:2455–69. [aVB]
- Molinari, M., Solida, A., Leggio, M. G., Petrosini, L., Ciorra, R. & Gainotti, G. (1995) Procedural learning in patients with focal cerebellar lesions (part 1). *Society for Neuroscience Abstracts* 21:270. [MM]
- Morasso, P. & Sanguineti, V. (1995) Self-organizing body-schema for motor planning. *Journal of Motor Behavior* 26:131–48. [PM]
- (in press) From cortical maps to the control of muscles. In: *Self-organization, computational maps, and motor control*, ed. P. Morasso & V. Sanguineti. Elsevier. [PM]
- Mugnaini, E. (1976) Organization of cerebellar cortex. *Experimental Brain Research (Suppl.)* 1:8–19. [aVB]
- (1983) The length of cerebellar parallel fibers in chicken and rhesus monkey. *Journal of Comparative Neurology* 220:7–15. [aVB]
- Munk, M. H. J., Roelfsema, P. R., König, P., Engel, A. K. & Singer, W. (1996) Role of reticular activation in the modulation of intracortical synchronization. *Science* 272:271–74. [WAM]
- Nahvi, M. J. & Hashemi, M. R. (1985) A synthetic motor control system; possible parallels with transformations in cerebellar cortex. In: *Cerebellar functions*, ed. J. R. Bloedel, J. Dichgans & W. Precht. Springer-Verlag. [aVB]
- Napper, R. M. A. & Harvey, R. J. (1988) Number of parallel fiber synapses on an individual Purkinje cell in the cerebellum of the rat. *Journal of Comparative Neurology* 274:168–77. [aVB]
- Nawrot, M. & Rizzo, M. (1995) Motion perception deficits from midline cerebellar lesions in human. *Vision Research* 35:723–31. [RCM]
- Nelson, J. I., Salin, P. A., Munk, M. H., Arzi, M. & Bullier, J. (1992) Spatial and temporal coherence in cortico-cortical connections: A cross-correlation study in areas 17 and 18 in the cat. *Visual Neuroscience* 9:21–37. [CS]
- Nicholson, C. & Llinás, R. (1971) Field potentials in the alligator cerebellum and their relationship to Purkinje cell dendritic spikes. *Journal of Neurophysiology* 34:509–531. [aVB]
- Nieuwenhuys, R. & Nicholson, C. (1967) The cerebellum of mormyrids. *Nature* 215:764–65. [JM]
- Nieuwenhuys, R. & Nicholson, C. (1969) Aspects of the histology of the cerebellum of Mormyrid fishes. In: *Neurobiology of cerebellar evolution and development*, ed. R. Llinás. American Medical Association. [rVB]
- Nikundiwe, A. M., Bjaalie, J. G. & Brodal, P. (1994) Lamellar organization of pontocerebellar neuronal populations: A multi-tracer and 3-D computer reconstruction study in the cat. *European Journal of Neuroscience* 6:173–86. [JGB]
- Nitzschke, M. F., Kleinschmidt, A., Wessel, K. & Frahm, J. (1996) Somatotopic motor representation in the human anterior cerebellum. *Brain* 119:1023–29. [PT]
- Oscarsson, O. (1969) The sagittal organization of the cerebellar anterior lobe as revealed by the projection patterns of the climbing fiber system. In: *Neurobiology of cerebellar evolution and development*, ed. R. Llinás. American Medical Association. [aVB]
- (1973) Functional organization of spinocerebellar paths. In: *Somatosensory system: vol. 1. Handbook of sensory physiology*, ed. A. Iggo. Springer-Verlag. [MG]
- (1976) Spatial distribution of climbing and mossy fibre inputs into the cerebellar cortex. *Experimental Brain Research* 1(suppl):36–42. [aVB, MG]
- (1979) Functional units of the cerebellum: Sagittal zones and microzones. *Trends in Neuroscience* 143–45. [aVB]
- (1980) Functional organization of olivary projections to the cerebellar anterior lobe. In: *The inferior olivary nucleus: Anatomy and physiology*, ed. J. Courville, C. Montigny de & Y. Lamarre. Raven. [aVB, MAA]
- Øverby, S. E., Bjaalie, J. G. & Brodal, P. (1989) Uneven densities of corticopontine neurons in the somatosensory cortex: A quantitative experimental study in the cat. *Experimental Brain Research* 77:653–65. [JGB]
- Palay, S. L. & Chan-Palay, V. (1974) Cerebellar cortex: *Cytology and organization*. Springer-Verlag. [aVB]
- Paulin, M. G. (1989) A Kalman filter theory of the cerebellum. In: *Dynamic interactions in neural networks: Models and data*, ed. M. A. Arbib & S. Amari. Springer-Verlag. [RCM]
- (1993) The role of the cerebellum in motor control and perception. *Brain Behavior and Evolution* 41:39–50. [EC, RCM, MGP]
- (1997) Neuronal representations of moving systems. In: *The cerebellum and cognition* (International Review of Neurobiology, vol. 41), ed. J. D. Schmahmann. Academic Press. [MGP]
- Petrosini, L., Molinari, M. & Dell'Anna, M. E. (1996) Cerebellar contribution to spatial event processing: Morris water maze and T-maze. *European Journal of Neuroscience* 9:1882–96. [MM]
- Pichtpornchai, C., Rawson, J. A. & Rees, S. (1994) Morphology of parallel fibres in the cerebellar cortex of the rat: An experimental light and electron microscopic study with biocytin. *Journal of Comparative Neurology* 342:206–20. [aVB]
- Poppele, R., Perciavalle, V. & Bosco, G. (1996) Spatial organization of proprioception in the spinocerebellum [abstract]. *Neural Control of Movement* 1:38. [REP]
- Pribam, K. (1991) *Brain and perception: Holonomy and structure in figural processing*. Erlbaum. [RES]
- Rakic, P. (1972) Extrinsic cytological determinants of basket and stellate cell dendritic pattern in the cerebellar molecular layer. *Journal of Comparative Neurology* 146:335–54. [aVB]
- Ramón y Cajal, S. (1911) *Histologie du système nerveux de l'homme et vertébrés*, vol. 2. Maloine. [aVB]
- Ratliff, F. (1965) *Mach bands: Quantitative studies on neural networks in the retina*. Holden-Day. [aVB]

- Regan, L. J. (1991) Voltage-dependent calcium currents in Purkinje cells from rat cerebellar vermis. *Journal of Neuroscience* 11(7):2259–69. [aVB]
- Riley, H. A. (1928) The mammalian cerebellum. *Arch. Neurol. Psychiat.* 20:895–1034. [aVB]
- Rispaal-Padel, L., Cicerata, F. & Pons, C. (1982) Cerebellar nuclear topography of simple and synergistic movements in the baboon. *Experimental Brain Research* 47:365–80. [MD]
- Robertson, L. T. (1984) Topographic features of climbing fiber input in the rostral vermal cortex of the cat cerebellum. *Experimental Brain Research* 55:445–54. [aVB]
- (1985) Somatosensory representation of the climbing fiber system in the rostral intermediate cerebellum. *Experimental Brain Research* 61:73–86. [aVB]
- Robertson, L. T., Laxer, K. D. & Rushmer, D. S. (1982) Organization of climbing fiber input from mechanoreceptors to lobule V vermal cortex of the cat. *Experimental Brain Research* 46:281–91. [aVB]
- Roby-Brami, A. & Burnod, Y. (1995) Learning a new visuomotor transformation: Error correction and generalization. *Cognitive Brain Research* 2:229–42. [MD]
- Roestorff, G. (1994) *Path integral approach to quantum physics: An introduction*. Springer-Verlag. [RES]
- Ross, W. N., Lasser-Ross, N. & Werman, R. (1990) Spatial and temporal analysis of calcium-dependent electrical activity in guinea pig Purkinje cell dendrites. *Proceedings of the Royal Society of London B* 240:173–85. [aVB]
- Sainburg, R. L., Ghilardi, M. F., Poizner, H. & Ghez, C. (1995) Control of limb dynamics in normal subjects and patients without proprioception. *Journal of Neurophysiology* 73:820–35. [HT]
- Sasaki, K., Oka, H., Kawaguchi, S., Jinnai, K. & Yasuda, T. (1977) Mossy fibre and climbing fibre responses produced in the cerebellar cortex by stimulation of the cerebral cortex in monkey. *Experimental Brain Research* 29:419–28. [aVB]
- Scheibel, A. B. (1977) Sagittal organization of mossy fiber terminal system in the cerebellum of the rat: A Golgi study. *Exp. Neurol.* 57:106770. [aVB]
- Schild, R. F. (1980) Length of the parallel fibers in rat cerebellar cortex. *Journal of Physiology (London)* 303:25. [aVB]
- Schwartz, A. B., Kettner, R. E. & Georgopoulos, A. P. (1988) Primate motor cortex and free arm movements to visual targets in three-dimensional space: 1. Relations between single cell discharge and direction of movement. *Journal of Neuroscience* 8:291327. [aVB]
- Schweighofer, N., Arbib, M. A. & Dominey, P. F. (1996a) A model of adaptive control of saccades: 1. The model and its biological substrate. *Biological Cybernetics* 75:19–28. [MAA]
- Schweighofer, N., Arbib, M. A. & Kawato, M. (1996b) Role of the cerebellum in reaching quickly and accurately: 1. A functional anatomical model of dynamics control. Submitted. [MAA]
- Schweighofer, N., Spoelstra, J., Arbib, M. A. & Kawato, M. (1996c) Role of the cerebellum in reaching quickly and accurately: 2. A detailed model of the intermediate cerebellum. Submitted. [MAA]
- Shadlen, M. N. & Newsome, W. T. (1994) Noise, neural codes and cortical organization. *Current Opinion in Neurobiology* 4:569–79. [CS]
- Shambes, G. M., Beerman, D. H. & Welker, W. I. (1978a) Multiple tactile areas in cerebellar cortex: Another patchy cutaneous projection to granule cell columns in the rat. *Brain Research* 156:123–28. [aVB]
- Shambes, G. M., Gibson, J. M. & Welker, W. (1978) Fractured somatotopy in granule cell tactile areas of rat cerebellar hemispheres revealed by micromapping. *Brain Behavior and Evolution* 15:94–140. [aBV, DJ]
- Shaw, R., Kadar, E. E. & Kinsella-Shaw, J. (1995) Modeling systems with intentional dynamics: A lesson from quantum mechanics. In: *Origins of self-organization*, ed. K. Pribam. Erlbaum. [RES]
- Shaw, R. E., Kadar, E. E. & Turvey, M. T. (1997) The job description of the cerebellum and a candidate model of its “tidal wave” function. *Behavioral and Brain Sciences* 20(1):37 [EEK]
- Shinoda, Y., Sugiuchi, Y., Futami, T. & Izawa, R. (1992) Axon collaterals of mossy fibers from the pontine nucleus in the cerebellar dentate nucleus. *Journal of Neurophysiology* 67:547–60. [aVB]
- Silveri, M. C., Leggio, M. G. & Molinari, M. (1994) The cerebellum contributes to linguistic production: A case of agrammatic speech following a right cerebellar lesion. *Neurology* 44:2047–50. [MM]
- Silveri, M. C., Misciagna, S., Leggio, M. G. & Molinari, M. (in press) Spatial dysgraphia and cerebellar lesion: A case report. *Neurology*. [MM]
- Snider, R. S. & Stowell, A. (1942) Receiving areas of the tactile, auditory and visual systems in the cerebellum. *Journal of Neurophysiology* 7:331–57. [aVB]
- Soechting, J. F., Ranish, N. A., Palminteri, R. & Terzuolo, C. A. (1976) Changes in a motor pattern following cerebellar and olivary lesions in the squirrel monkey. *Brain Research* 105:21–44. [aVB, JSG]
- Softky, W. (1994) Sub-millisecond coincidence detection in active dendritic trees. *Neuroscience* 58:13–41. [CS]
- Softky, W. R. & Koch, C. (1993) The highly irregular firing of cortical cells is inconsistent with temporal integration of random EPSPs. *Journal of Neuroscience* 13:334–50. [CS]
- Sultan, F. (1994) Vergleichende Untersuchung über die Flächenausdehnung der Kleinhirnrinde: Ein Beitrag zu einem Modell der Kleinhirnfunktion. Thesis, University of Tuebingen, Germany. [aVB]
- (1996) Timing and the cerebellar microcircuit: Axons tuned to synchronicity [abstract]. *Computational Neuroscience Meeting*. [aVB]
- Sultan, F. & Bower, J. (1996) Classification of the rat cerebellar basket and stellate cells: Evidence for a continuous distribution of types through principal component analysis [abstract]. *Society for Neuroscience* 22. [aVB, JMB]
- Sultan, F. & Braitenberg, V. (1993) Shapes and sizes of different mammalian cerebella. A study in quantitative comparative neuroanatomy. *Journal für Hirnforschung* 34:79–92. [aVB, JGB, RCM]
- Sultan, F. & Rotter, S. (1994) Distribution of the parallel fiber swellings in the cat's cerebellar cortex: Simple constraints may underlie a remarkably regular design. In: *Sensory transduction*, ed. N. Elnsner & H. Breer. Stuttgart: Thieme. [aVB]
- Sultan, F., Ellisman, M. H. & Bower, J. M. (1995) Quantitative anatomical aspects of the inhibitory interneurons of the rat cerebellar molecular layer: A light and electron microscopic Golgi study. *Society for Neuroscience Abstracts* 21:1191. [DJ]
- Thach, W. T. (1967) Somatosensory receptive fields of single units in cat cerebellar cortex. *Journal of Neurophysiology* 30:675–96. [aVB]
- (1970) Discharge of cerebellar neurons related to two maintained postures and two prompt movements: 2. Purkinje cell output and input. *Journal of Neurophysiology* 33:537–47. [aVB]
- (1972) Cerebellar output: Properties, synthesis and uses. *Brain Research* 40:89–97. [aVB]
- Thach, W. T., Goodkin, H. & Keating, J. (1992) The cerebellum and the adaptive coordination of movement. *Annual Review of Neuroscience* 15:403–42. [MAA]
- Thompson, J. H., Lyngstad, K. A., Bjaalie, J. G. & Bower, J. M. (1995) Perioral regions of somatosensory cortex project to corresponding cerebellar regions through spatially restricted domains within the pontine nuclei. *Society for Neuroscience Abstracts* 21:467. [JGB]
- Thompson, R. F. & Krupa, D. J. (1994) Organization of memory traces in the mammalian brain. *Annual Review of Neuroscience* 17:519–49. [JSG]
- Tolbert, D. L. & Alinsky, J. M. (1994) Convergence and divergence of spinal and spinal cuneate mossy fiber inputs to the rat cerebellar anterior lobe. *Society for Neuroscience Abstracts* 20:1748. [REP]
- Topka, H., Konczak, J., Schneider, D. & Dichgans, J. (1996) Three-dimensional upper limb movements in cerebellar ataxia. In: *Three-dimensional kinematic principles of eye, head and hand movements*, ed. M. Fetter & T. Haslwanter. Harwood. [HT]
- Torres-Aleman, I., Pons, S. & Santos-Benito, F. F. (1992) Survival of Purkinje cells in cerebellar cultures is increased by insulin-like growth factor I. *European Journal of Neuroscience* 4:864–69. [aVB]
- Trott, J. R. & Armstrong, D. M. (1987a) The cerebellar corticonuclear projection from lobule Vb/c of the cat anterior lobe: A combined electrophysiological and autoradiographic study: 2. Projections from the vermis. *Experimental Brain Research* 68:339–54. [aVB]
- (1987b) The cerebellar corticonuclear projection from lobule Vb/c of the cat anterior lobe: A combined electrophysiological and autoradiographic study: 1. Projections from the intermediate region. *Experimental Brain Research* 66:31838. [aVB]
- Tyrrell, T. & Willshaw, D. (1992) Cerebellar cortex: Its simulation and the relevance of Marr's theory. *Philosophical Transactions of the Royal Society B* 336:239–57. [GAC]
- Van Der Want, J. J. L., Guegan, M., Wiklund, L., Buisseret-Delmas, C., Ruigrok, T., & Voogd, J. (1989) Climbing fibre “collaterals” innervation of the central cerebellar nuclei studied with anterograde *Phaseolus vulgaris*-leucoagglutinin (PHA-L) labelling. In: *The olivocerebellar system in motor control*, ed. P. Strata. Springer-Verlag. [aVB]
- Vassbo, K., Nicotra, G., Wiberg, M. & Bjaalie, J. G. (1996) Somatosensory input to the monkey cerebellum: De-emphasis of distal extremities demonstrated in computerized 3-D maps. *Society for Neuroscience Abstracts* 22:203. [JGB]
- Vilis, T. & Hore, J. (1977) Effects of changes in mechanical state of limb on cerebellar intention tremor. *Journal of Neurophysiology* 40:1214–24. [PT]
- (1980) Central neural mechanisms contributing to cerebellar tremor produced by limb perturbations. *Journal of Neurophysiology* 43:279–91. [JSG]
- Virji-Babul, N. & Cooke, J. D. (1995) Influence of joint interactional effects on



- the coordination of planar two-joint arm movements. *Experimental Brain Research* 103:451–59. [HT]
- Virji-Babul, N., Cooke, J. D. & Brown, S. H. (1994) Effects of gravitational forces on single-joint arm movements in humans. *Experimental Brain Research* 99:338–46. [HT]
- Voogd, J. & Bigaré, F. (1980) Topographical distribution of olivary and cortico nuclear fibers in the cerebellum: A review. In: *The inferior olivary nucleus: Anatomy and physiology*, ed. J. Courville. Raven. [aVB]
- Voogd, J. (1969) The importance of fiber connections in the comparative anatomy of the mammalian cerebellum. In: *Neurobiology of cerebellar evolution and development*, ed. R. Llinás. American Medical Association. [aVB]
- Vranesic, I., Iijima, T., Ichikawa, M., Matsumoto, G. & Knöpfel, T. (1994) Signal transmission in the parallel fiber. Purkinje cell system visualized by high-resolution imaging. *Proceedings of the National Academy of Sciences (USA)* 91:13014–17. [JSG]
- Wadman, W. J., Denier van der Gon, J. J. & Derksen, R. J. A. (1980) Muscle activation patterns for fast-goal directed arm movements. *Journal of Human Movement Studies* 6:19–37. [aVB]
- Wadman, W. J., Denier van der Gon, J. J., Geuze, R. H. & Mol, C. R. (1979) Control of fast goal-directed arm movements. *Journal of Human Movement Studies* 5:3–17. [aVB]
- Watson, P. J. (1978) Nonmotor functions of the cerebellum. *Psychological Bulletin* 85(5):944–67. [EC]
- Welker, W. (1987a) Comparative study of cerebellar somatosensory representations: The importance of micromapping and natural stimulation. In: *Cerebellum and neuronal plasticity*, ed. M. Glickstein, C. Yeo & J. Stein. Plenum. [aVB]
- (1987b) Spatial organization of somatosensory projections to granule cell cerebellar cortex: Functional and connective implications of fractured somatotopy (summary of Wisconsin studies). In: *New concepts in cerebellar neurobiology*, ed. J. S. King. A. R. Liss. [JMB]
- Welsh, J. P., Lang, E. J., Sugihara, I. & Llinás, R. (1995) Dynamic organization of motor control within the olivocerebellar system. *Nature* 374:453–57. [RJH, WAM]
- Wilbert, R. & Guay, M. (1985) Long-term memory for a single movement. In: *Differing perspectives in motor learning, memory, and control*, ed. D. Goodman, R. Wilberg & I. Franks. North-Holland/Elsevier. [PM]
- Wild, B., Klockgether, T. & Dichgans, J. (1996) Acceleration deficit in patients with cerebellar lesions. A study of kinematic and EMG-parameters in fast wrist movements. *Brain Research* 713:186–91. [WAM, HT]
- Woolston, D. C., Kassel, J. & Gibson, J. M. (1981) Trigemino-cerebellar mossy fiber branching to granule cell layer patches in the rat cerebellum. *Brain Research* 209:255–69. [aVB]
- Yeo, C. H. (1991) Cerebellum and classical conditioning of motor responses. *Annals of the New York Academy of Sciences* 627:292–304. [JSG]