

RESEARCH ARTICLE

Take-off performance of a single engine battery-electric aeroplane

G.B. Gratton¹, T. Delaney¹, B. Zaghari² and G. Kendall³

¹Faculty of Engineering and Applied Science, Cranfield University, Bedford, UK

²School of Electronics and Computer Science, University of Southampton, Southampton, UK

³CDO2 Limited, London House, Mayfield, East Sussex, UK

Corresponding author: G.B. Gratton; Email: guy.gratton@cranfield.ac.uk

Received: 7 November 2023; **Revised:** 1 June 2024; **Accepted:** 25 June 2024

Keywords: Electric Flight; Take-off; Aircraft certification; Aeroplane performance; CS-23

Abstract

This paper investigates the take-off performance of a single engine battery-electric aeroplane, using the example of the 300kg Sherwood eKub. It shows analysis of take-off performance of such an aeroplane must include as a minimum two new parameters not normally considered: time at full throttle and state of charge. It was shown in both ground and flight test that the state of available power reduces both as the throttle is fully open, and as battery charge is consumed, although recovers partially when power is reduced for a period. It is possible to schedule take-off performance as a function of the usual parameters plus state of charge. Because of the reducing climb performance with use of state of charge, and the requirement in airworthiness standards for minimum climb performance being available, it becomes necessary to introduce the concept of minimum-indicated state of charge for take-off, $SoCi_{MTO}$; means to calculate that are shown for compliance with both microlight aeroplane standards and larger aeroplane standards, and the calculations are demonstrated for the eKub. Conclusions are also drawn about the use of commercial products SkyDemon and Google Earth for recording and analysing aeroplane performance data.

Nomenclature

EnaEl	Enabling Aircraft Electrification (project name)
MTOM	Maximum Take-Off Mass
OAT	Outside Air Temperature
PD _{sys}	system voltage (Note that PD rather than V is used to define voltage, so as to prevent confusion with $V_{\text{subscript}}$ airspeed definitions.)
QFE	altimeter setting to give a reading of zero on an airport runway threshold
sHd	standard density altitude (standardised to ISA conditions)
SOAP	state of available power at any moment
SoC	State of Charge (suffixed <i>i</i> for indicated, and <i>t</i> for true, where relevant to do so)
$SoCi_{MTO}$	minimum indicated State of Charge for take-off
SoH	(battery) state of health
TAFT	Time At Full Throttle
T_B	battery system core Temperature
T_C	controller (inverter) core Temperature
T_M	motor core Temperature
TOD	Take-Off Distance
TOR	Take-Off Run
V_H	maximum achievable speed in level flight
V_{S0}	stall speed with full flaps
V_{S1}	stall speed, flaps up



Figure 1. Sherwood eKub test aircraft (Keith Wilson).

1.0 Introduction

1.1 The project

The Sherwood eKub (Fig. 1), which is a single-seat high-wing tailwheel aeroplane substantially (apart from powertrain) identical to the existing Sherwood Kub aeroplane, has flown a series of tests of take-off, climb and cruise performance, including the particular objective of understanding how to create a performance manual for a battery electric aeroplane. The creation of such manuals is extremely well understood for aircraft with conventional powertrains, but a completely new subject for aircraft with a battery-electric powertrain. The world's only, so-far, certified such aeroplane, the Pipistrel Velis Electro, is certified in the sub-ICAO light sports aircraft [1] category which does not require robust performance data and none such has been published. The aeroplanes built for EnabEI, which are in the microlight category, also do not require such data, but in this case the project has elected to carry out such testing and publish the results and conclusions, which is possible and achievable. The reasons for doing so were primarily as research objectives, rather than regulatory need for the specified aircraft.

The baseline standard for light aeroplane certification worldwide is the group of airworthiness standards known as part 23, encompassing CS.23 [2] and 14 CFR part 23 [3]. That has been the primary basis for testing in this research, particularly as interpreted by AC23-8 [4].

The powertrains considered in this paper are as simple as is reasonably possible, that is they consist of one or more battery packs connected in parallel (thus not modifying voltage) to a controllable inverter (sometimes also called the controller) which converts the DC output of the batteries to a similar voltage three-phase alternating current, which then in turn is used by the motor to create torque and speed at the propeller.

1.2 Battery-electric powertrains

The design of battery-electric powertrains for manned aircraft is a relatively new problem and driven by the need to optimise total system weight, component efficiencies, thermal management, integration and coupling, and specific technologies and sustainability aspects. The powertrain must consist of power and energy sources (batteries or fuel cells), power converters (power electronics and electric machines), thermal management, (a) propeller(s) and potentially also a gearbox. To decide how these components are selected and how they are connected as an architecture, we need to decide on the

priorities between the systems and aircraft's key performance indicators and the aircraft requirements [5] as well as the requirements for coupling the components [6]. For example, in some cases depending on the flight power requirement and design constraints specific architectures can be designed and developed [7, 8]. Whilst most considered thought is that batteries are an interim technology due to their relatively poor energy storage density, much research on electric powertrains nonetheless remains presently focused on battery technology [9], offering higher energy densities, safety, and faster charging times. Modern electric motors with integrated drives with high efficiencies (close to 90%) [10], while power electronics are evolving with high-efficiency inverters using silicon carbide (SiC) and gallium nitride (GaN) semiconductors. Integration of advanced thermal management systems [11], careful wiring and fault management and intelligent software control are further enhancing the efficiency, performance and sustainability of electric aircraft.

Electric powertrain design, similar to most other aircraft design aspects, is characterised by weight minimisation whilst achieving acceptable performance, particularly propulsive efficiency; practical experience has also shown considerable need to achieve thermodynamic management with overtemperatures (variously at batteries, inverters or motors) often limiting performance [12]. Currently the primary focus is on mass per available energy, which compared to existing fuel-burning powertrain designs is problematic on conventional aeroplanes, and far more so for the many prospective eVTOL aircraft [13]. Through advanced modeling and empirical data, Ref. [14] investigates the impact of flight profiles, mission scenarios, and charging strategies on the battery's degradation rate and overall cycle life, offering insights into optimising the eVTOL drone's energy management system, including recommendations for optimal charging protocols and mission planning to extend battery lifespan while meeting operational requirements. Reference [15] consisting of 22 cells with 21,392 charge and discharge cycles presents a comprehensive battery dataset tailored for electric vertical takeoff and landing aircraft, aiming to support research and development. The dataset includes detailed information on various battery parameters such as capacity, voltage, discharge rates and temperature profiles under different flight conditions, including takeoff, climb, cruise and landing.

NASA has released its findings through its reconfiguration to enable altitude testing of megawatt-scale electric machines for electrified aircraft ground testing. This programme: NEAT's ability to simulate high-altitude conditions has provided insights into the performance, thermal management and reliability of large electric propulsion systems for aircraft [16].

As the car industry is more mature in terms of powertrain electrifications, there are several published studies on the performance of the drivetrain e.g. Refs [17, 18]. The main objectives in designing a powertrain for an electric vehicle are to maximise energy efficiency, driving range and performance while ensuring long-term reliability and cost effectiveness. This involves optimising components such as motors, batteries and charging systems to create a seamless and environmentally friendly driving experience. This contrasts somewhat to an aircraft where weight minimisation and performance maximisation are jointly paramount, with complexity and long-term life (subject to known reliability) being compromise points.

The relationship between state of charge (SoC) and performance is critical to understanding of battery-electric aeroplanes. This was explored by NASA in Ref. [19] which explained the flight tests conducted on a remaining flying time prediction system tailored for small electric aircraft (in reality model aircraft but with a similar configuration to the eKub described in this paper), specifically examining its performance under various fault conditions. This critical system offers real-time estimates of remaining flight time based on battery health and flight conditions, ensuring safe and reliable operations. Through flight evaluations, the researchers demonstrated the remaining flying time prediction system's accuracy and reliability, even in scenarios with sensor failures and unexpected battery behaviour. Their findings help the system's potential to enhance safety and operational efficiency in small electric aircraft, presenting valuable insights for the development and integration of such predictive systems into electric aviation platforms. Sustained flight beyond 30% SOC in the aircraft battery packs was identified as a high-risk operation for their experimental vehicle and is recommended to be avoided whenever feasible. While the flight tests did not meet the strict 5% ending SOC estimation error threshold, they

Table 1. *Sherwood eKub design characteristics*

Characteristics	Value	Unit
MTOM	300	kg
Empty mass	201	kg
V_{S0}	26	kts CAS
V_{S1}	29	kts CAS
V_X	45	kts CAS
Span	7.98	m
Length	5.00	m
Propeller diameter	1.6	m
Propeller pitch	3	degrees
PD_{SYS}	57	Volts
Maximum system power	28	kW

were close to meeting it, achieving 82% compliance out of the 90% target. Furthermore, the criteria for the two-minute warning alarm to activate was met 93% of the time, surpassing the 90% requirement.

2.0 The aircraft and the issue

2.1 The problem of battery-electric aeroplane take-off performance

The problem of measuring and scheduling take-off and initial climb performance for a conventional aeroplane is extremely well understood and widely published upon. However, a battery-electric aeroplane introduces additional parameters not normally considered. These are particularly SoC and TAFT (time at full throttle). It is likely that SoH (state of health) must also be considered in the future as this programme was flown entirely with a relatively young powertrain with components in new condition. Existing parameters of wind, weight, slope and density altitude remain significant. However, it should also be considered that whilst density altitude effects upon airframe and wing should be unchanged compared to a conventional aeroplane, impacts upon a motor/propeller combination are such that whilst propellers will still be influenced by density effects, power source output should be unchanged, with the exception of air cooling/heat transfer and the consequent impact of air temperature upon system operating temperatures.

2.2 The test aircraft

The aeroplane tested in this programme was the Sherwood eKub (Fig. 1) registration G-EKUB, which was built as part of the Enabel: Enabling Aircraft Electrification project, and is a first-of-type derivative of the established Sherwood Kub single seat tailwheel high-wing single thrustline aeroplane, built by The Light Aircraft Company (TLAC) – see Table 1. The aeroplane is powered by five 3.5kWh 57V Lithium-ion battery packs, powering via an air-cooled inverter, a Geiger Engineering HP20 three-phase air cooled motor, and eProp CFRP ground adjustable two-blade propeller. Carrying through from batteries to motor, are five sets of parallel DC cabling into an inverter inlet bus-bar, the 28kVA DC to 3-phase inverter, then parallel 3-phase cabling from inverter to motor (Fig 2). Independently conducted flight test articles on the aircraft can be found at Refs [20, 21]. Whilst design analysis favoured a three-battery system as the most design efficient solution (more giving greater system mass, less giving insufficient excess power to reliably permit a go-around in the event of a single pack failure), the choice to use a five-battery system was driven by availability of suitable commercial off-the-shelf (COTS) components within the project timescale. The batteries, massing 15.5kg each, were located two in each wing root, and one in the nose between the motor and firewall; battery locations were driven by the combination of available space within the airframe and the need to maintain centre of gravity within limits.

Table 2. Sample full throttle test (pre first flight, 20 Dec 2021)

Time (s)	Motor temperature (°C)	Power (kW)
0	20	27
20	28	25.3
30	38	26.7
40	46	23.7
50	52	26
60	56	24

At time of writing, G-EKUB has flown 31 sorties, totalling a little over 20 flying hours. The greatest endurance actually demonstrated has been 54 minutes from take-off to landing, and the greatest altitude demonstrated has been 6,300ft above airfield elevation.

2.3 Instrumentation and consideration of errors

Automated data recording was available from (a) SkyDemon flight planning application recording GPS data at 0.2Hz; (b) the Geiger Engineering ADI (advanced drive interface) unit fitted to the aircraft's instrument panel (Fig 3). Manual data recording was by the test pilot, who had reference to normal flight instruments, the ADI unit's display, and also a uAvionics AV30 mini-EFIS [22] (electronic flight instrumentation system) fitted into the aircraft's instrument panel – incorporating digital solid state direction indicator and attitude indicator, as well as additional indicated airspeed and pressure altitude. Timing was by reference both to SkyDemon automated recording, and a synchronised personal chronometer.

Ground and local weather conditions were determined by observation, using a calibrated 15kt windsock [23] at the Little Snoring test airfield, and the official Meteorological Observations from a nearby military aerodrome, RAF Marham (20nm to the North, with very few obstructions or changes in terrain between the two thus also considered a good representation).

It was assumed that measurements of temperature (air temperatures and system components) were exact within reading precision. SoC was calibrated in ground test detailed below, and the pitot-static system had been calibrated in previous flight test using the GPS racetrack method. Reading precision of instruments was $\pm 1^\circ\text{C}$ for temperatures (assumed exact), $\pm 2\text{mph}$ for airspeed (previously calibrated against GPS), $\pm 10\text{ft}$ for pressure altitude (presumed exact over the small distances between ground and circuit height), $\pm 0.1\text{kW}$ for power (presumed exact). Measurement of take-off distances using GPS (descriptions below) was precise to $\pm 10\text{m}$ in the horizontal plane and $\pm 2\text{m}$ in the vertical axis with GPS data otherwise assumed to be exact.

2.4 The concept of TAFT and why do we think it matters?

TAFT is a new concept which was identified early in this programme as the powertrain was integrated and tested on G-EKUB prior to first flight. It was observed with the early, powertrain prototype, where ground testing showed that after selection of full power via the aircraft throttle (a potentiometer on the left hand side of the cockpit, feeding a signal to the ADI unit and thence to the inverter) that initial power reduced markedly with time. For example Table 2 shows the results for an early test at full throttle, where SOAP (the maximum available power available at any moment) drops off by over 10% in the first minute. Motor temperature appeared to be a factor in this, and that was emphasised during early test flying where it was found that initially available climb performance degraded rapidly within the first few minutes of a flight.

This motor temperature effect – both impacting performance and safety became deeply problematic during early flight testing, to a far greater extent than predicted at the design and ground test phases, as illustrated by a six-minute performance climb from take-off through a throttle retard to keep temperature down to 18kW at 1 minute, until the throttle was further retarded to prevent motor overheat at six minutes

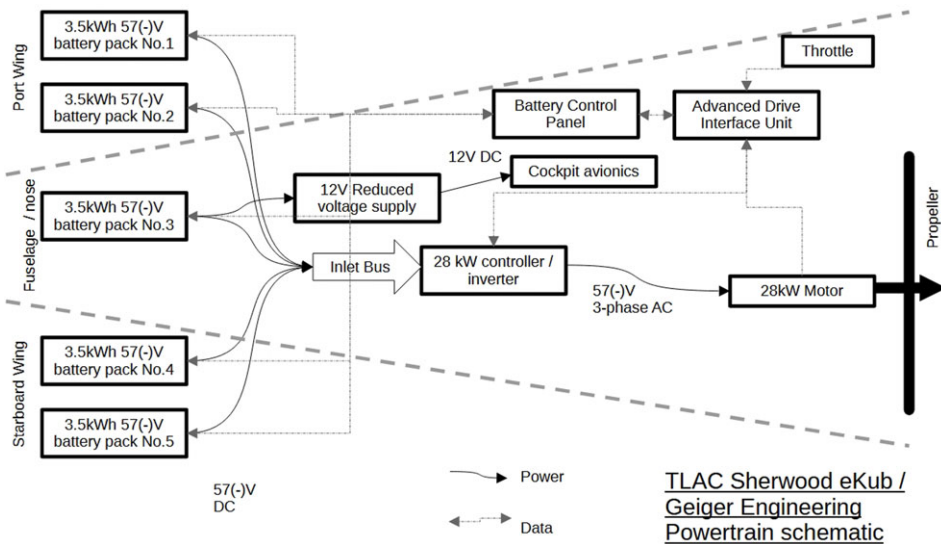

Figure 2. *Sherwood eKub powertrain schematic.*



Figure 3. *Sherwood eKub's instrument panel. Left to right showing eSTOP emergency powertrain control, battery management panel, AV30 mini-EFIS, altimeter, cockpit thermometer (above), turn co-ordinator (below), airspeed indicator, ADI unit, VHF radio.*

in Fig. 4. This shows a marked drop-off in climb performance with time at a fixed throttle setting, despite relatively small changes in altitude: see Table 3; the inevitable conclusion was that the major player was motor temperature. It was also a critical point in the flight test programme where it was concluded that the aircraft's motor cooling capability was inadequate to the task as the degree to which the test pilot was having to manage throttle setting and airspeed was unacceptable, leading to a five-month pause in the flight test programme whilst the cooling system was redesigned, tested and authorised for a return to flight.

After the aircraft's return to flight in November 2022, the motor temperature was now continuously below 65°C irrespective of powertrain handling, keeping it well below the programme target limit of 85°C and the system auto-retard condition of 95°C. Climb performance, with no other changes to the aircraft and powertrain except for improved cooling, was about 20% better at identical conditions and

Table 3. Critical factors during sortie 14 climb

Time (minutes)	Motor temperature (°C)	Climb rate (fpm)	Indicated power (kW)	Battery SoCi (%)
0	40	300	25	80
1	75	250	18	78
2	78	200	17	75
4	86	100	16.8	72
6	90	50	16.8	68

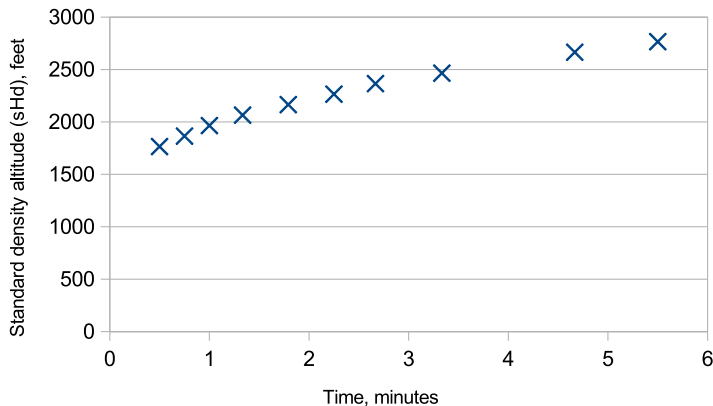
**Figure 4.** Sherwood eKub climb performance from take-off, sortie 14, 30 June 2022 (runway elevation approx 1,500ft sHd) test pilot observations.

a continuous full throttle climb was demonstrated through over 6,000ft. This reinforced the conclusion that motor temperature was a critical factor in determining SOAP, however it was still found in a new series of ground tests that there was a drop-off in SOAP which was not solely explainable from reducing SoC or from temperature – see Fig. 5. These tests, apart from the first at 101% SoCi (from 30°C) were all done from 50°C motor temperature and if, for example, the data for the 55% and 44% commencing SoC cases are considered it can be seen that at throttle retard after five minutes where full throttle power was 19kW, this recovered after about four minutes at idle (~200W) power to permit 19.8kW at full throttle. Motor temperature may have been a factor still: at the end of the 51%SoCi test $T_M=62^\circ\text{C}$, at the start of the 44%SoCi test $T_M=50^\circ\text{C}$) but it was also observed that the battery system voltage which had steadily dropped whilst discharging at high power, exhibited a significant recovery during the intervening four minutes at low power: the behaviour indicates that voltage, and voltage recovery is also therefore a TAFT contributor in addition to motor temperature. This is illustrated in Fig. 6, where the voltage drop during high discharge, and significant but not complete recovery of voltage at low discharge is very clear.

It is considered likely that inverter operating conditions and recent history may also influence TAFT effects. This is emphasised when considering the curve of total available power versus system voltage shown in Fig. 7 – demonstrating behaviour substantially the same as have also been seen in tests with only four of the five battery packs serviceable. Therefore voltage is confirmed to be only part of the position. However evidence towards (or against) that proposition is not available from this programme due to the generally very consistent self management of temperature by the inverter unit fitted.

The conclusion therefore is that TAFT is an important parameter in determining SOAP, and is a function of at least two internal parameters: motor temperature and system voltage, and likely in some aircraft at least a third – inverter temperature, and potentially a fourth – internal system logic. At a first

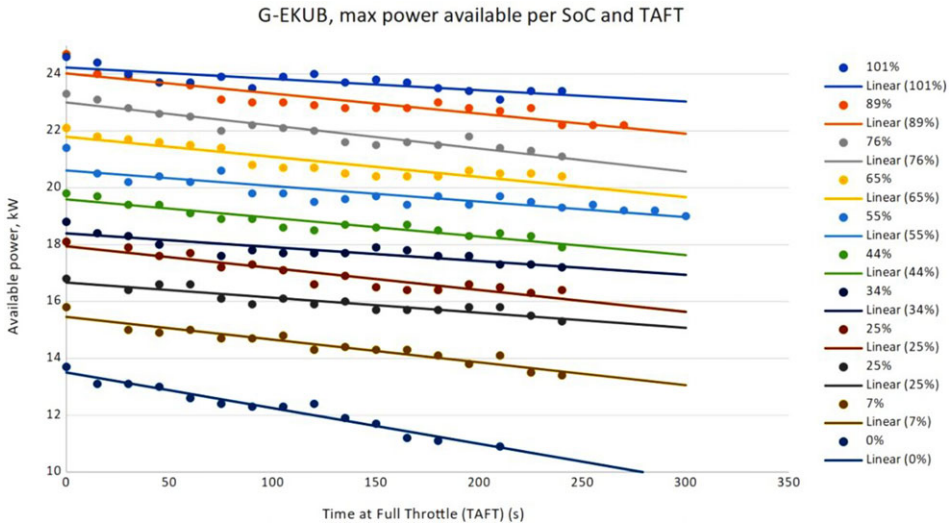

Figure 5. *eKub power versus TAFT during ground tests on 10 July 2023.*

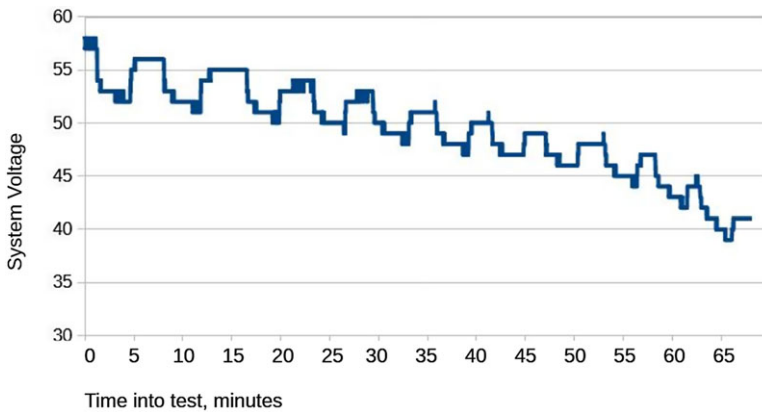

Figure 6. *eKub battery system voltage against time, during conduct of ground test shown in Fig. 5.*

approximation however it seems reasonable to assume that Equation (1) applies to any system.

$$\text{SOAP} = f(\text{SoC}) - k \cdot \text{TAFT} \tag{1}$$

The function f , and value of the multiplier k are unknown. By inspection of Fig. 5 we may however conclude that SoC as an indicated value is not an accurate descriptor of total energy reserves in this aeroplane at least (given that after initial charge $\text{SoC}_i = 101\%$, and from 0% , the motor could operate for another five minutes at about a mean of 11.5kW , giving residual energy of about 1kW or about 6% of the system declared capacity). In other words $f(\text{SoC}) \neq \text{SoC}$. If one assumed linearity between true and indicated SoC, in percent, which is probably reasonable, we can conclude Equation (2):-

$$\text{SoC}_t = (0.931 \text{ SoC}_i) + 6 \tag{2}$$

(Both parts of the equation in %).

This clearly only applies to this individual aeroplane and system, but is a useful working relationship for purposes of flight test data analysis, and indicative for other projects of the form of relationship they may encounter.

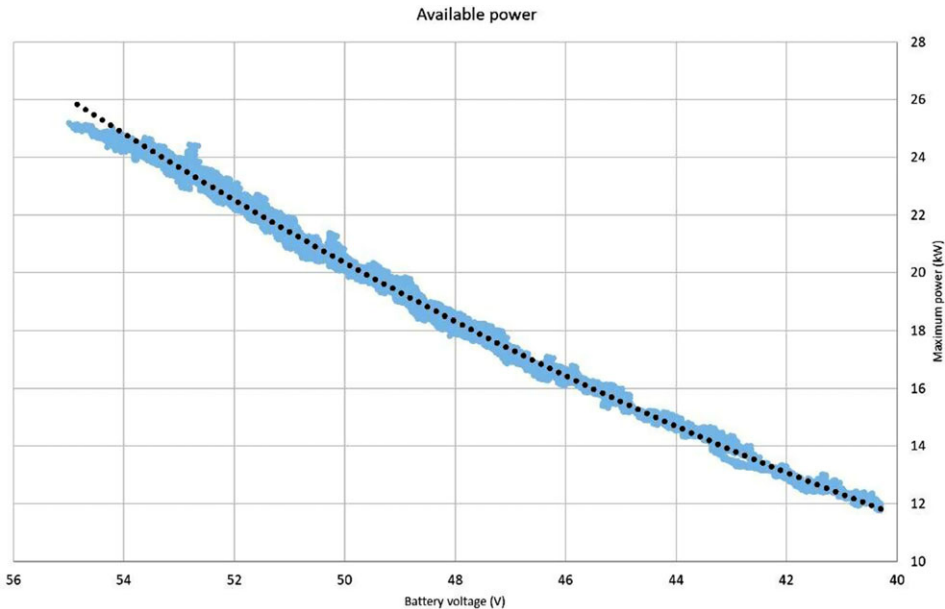

Figure 7. *eKub/Geiger powertrain available maximum power as a function of system voltage.*

3.0 Results and discussion

3.1 Actual take-off distances

Ultimately, irrespective of ground testing and theoretical analysis, aeroplane performance can only be determined accurately by actual flight test. The eKub is a test aeroplane, and has been used therefore to obtain such data; whilst many other flights for a range of systems, performance and handling evaluation have been made, the primary flight used in this paper was eKub sortie 30, flown on 26 July 2023 when a series of nine circuits were flown from the hard section of runway 25 at Little Snoring Aerodrome in Norfolk, UK (Fig 8). Wind was 8kts at 240° (in conformation of which all tests were at 55mph IAS = 47.5kts CAS = 48.2kts TAS = 48kts groundspeed component when corrected for an average 5.7° climb angle as they climbed through 30ft where wind is conventionally measured. The mean of those tests was a groundspeed of 38.8kts; $47.5 - 38 = 9.5$ kts windspeed at 30ft – close to the observed 8kts but the higher figure was used for subsequent calculations), air temperature was 19°C, air dewpoint was 11°C, surface air pressure (QFE) was 1003hPa: giving a density altitude of 1,060ft. All take-offs commenced at the start of the hard section of runway 25 (landings subsequently on the earlier grass section). Take-off distances were determined using automatically recorded data by SkyDemon [24] on the pilot's in-flight personal device, which was then analysed using Google Earth (Fig. 9).

The data were obtained by the test pilot (raw data obviously provided IAS, not CAS, but the Pitot-static system had previously been calibrated using the racetrack method [25] – the calibration curve is shown in Fig. 10, based upon previous flight testing), in addition to the automatically recorded data from SkyDemon. After take-off the aeroplane was always climbed straight ahead to 300ft AGL, when a right-hand turn was commenced through 90° heading change followed by a second right-hand turn approximately parallel to the runway at 400ft. The aeroplane was levelled at 600ft (requiring 13–14kW), and then two descending right-hand turns before a low powered descent to land on the grass runway segment (in piloting terms, approximately a standard right hand 600ft circuit; the relatively low circuit was flown to permit more circuits to be flown with the energy available).

As was expected, with reducing SoC, take-off run (TOR) and take-off distance (TOD) both increased. The full analysed results for actual conditions, with best fit quadratic curves (limited extrapolation from tested 37% SoCi down to 17% SoCi shown) are given in Fig. 11 with equations in the tested conditions

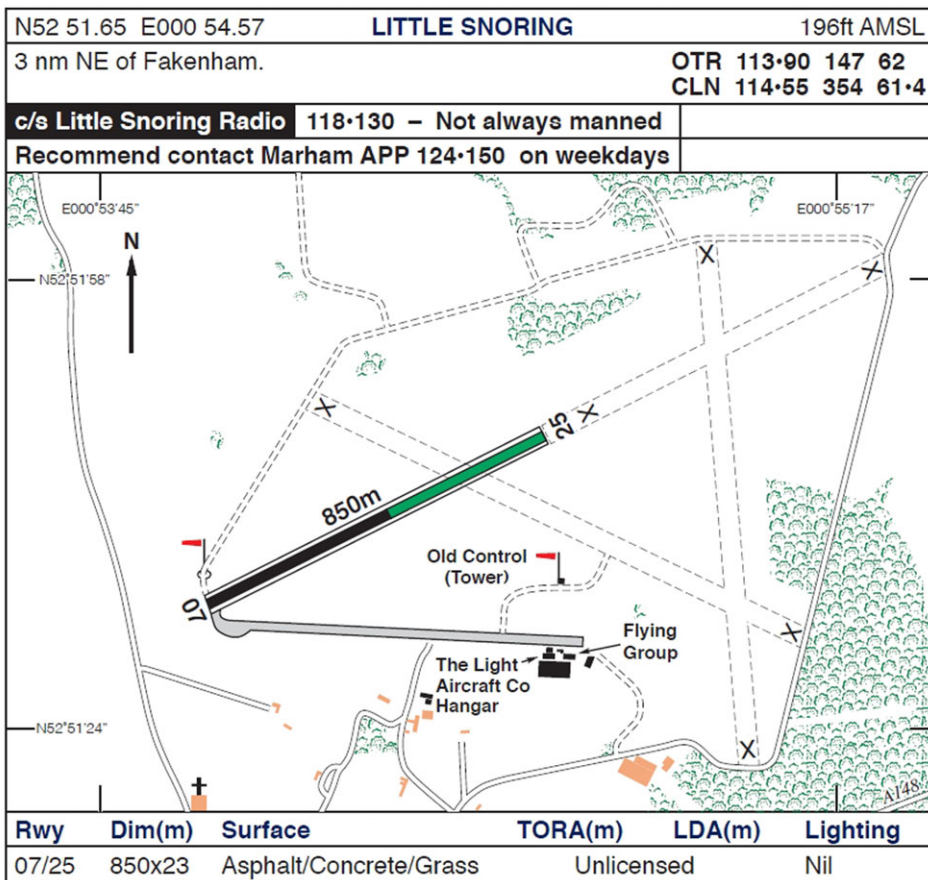

Figure 8. Little Snoring Airfield (from Pooleys UK VFR Flight Guide 2023).

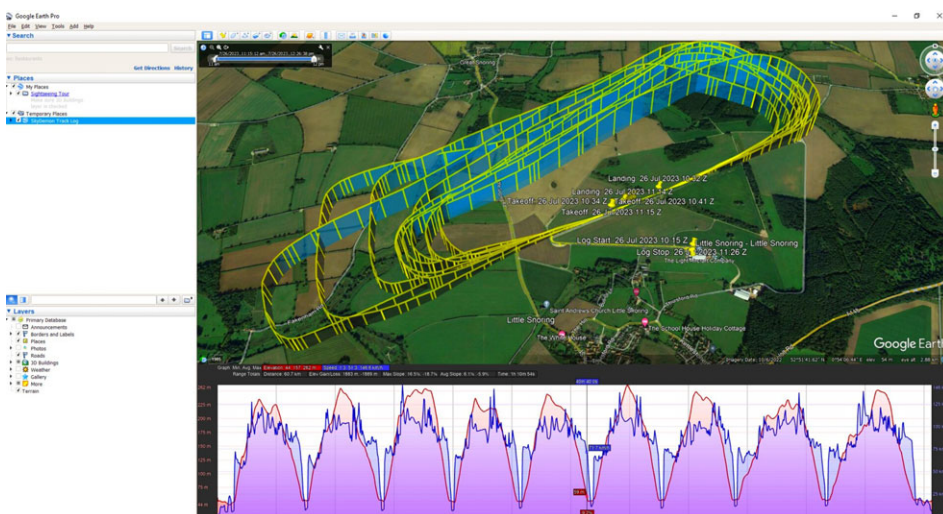

Figure 9. Google Earth analysis screen showing full sortie data.

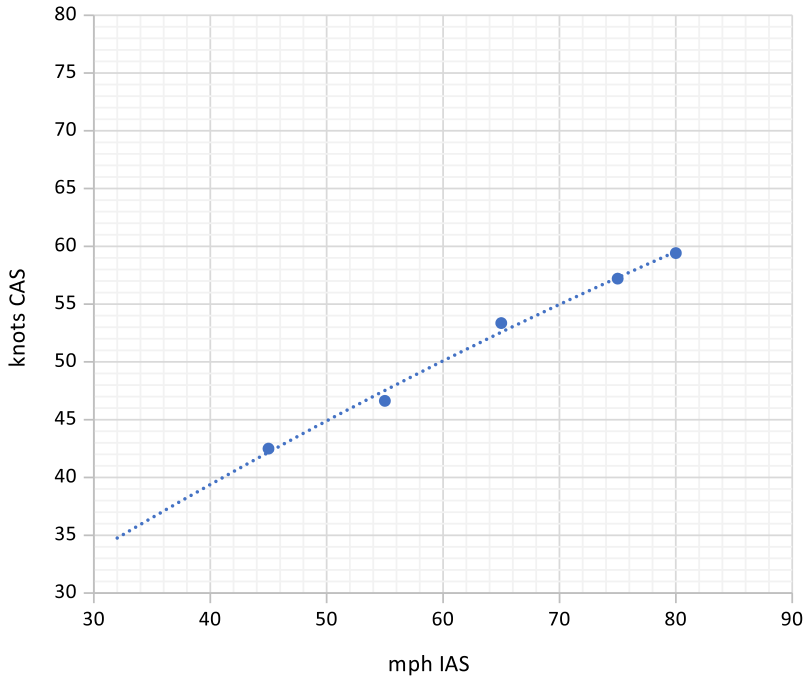

Figure 10. Sherwood eKub airspeed indication system calibration curve. Curve shown is lowest order (quadratic) best fit within ± 2 mphIAS precision, limited extrapolation below test speeds to clean stall.

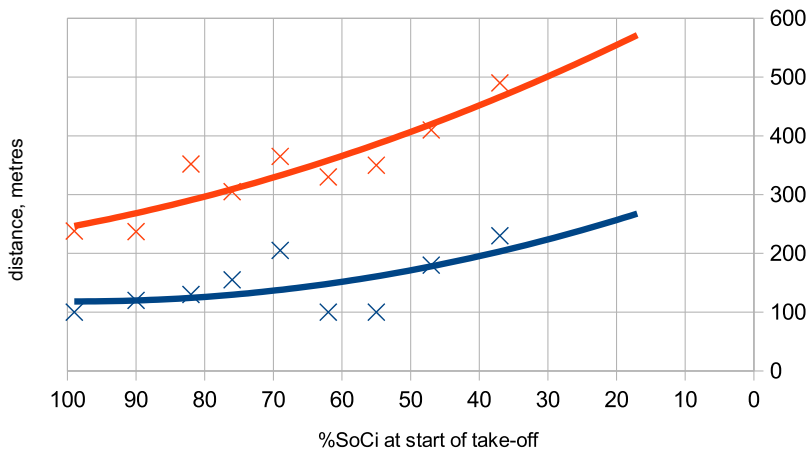

Figure 11. Sherwood eKub Take-Off Run and Take-Off Distance at Density Altitude 1,060ft with 9.5kt headwind. Nominal quadratic best fit curves with limited extrapolation to lower SoC below test conditions.

for TOR and TOD. What may be particularly observed at this stage is the marked increase in distances as the battery state of charge reduces.

3.2 Standardised take-off distances

It is normal to then standardise this data to ISA sea-level still air conditions, and then from that to provide extrapolations to non-standard conditions. This was done in this case by reversing the adverse

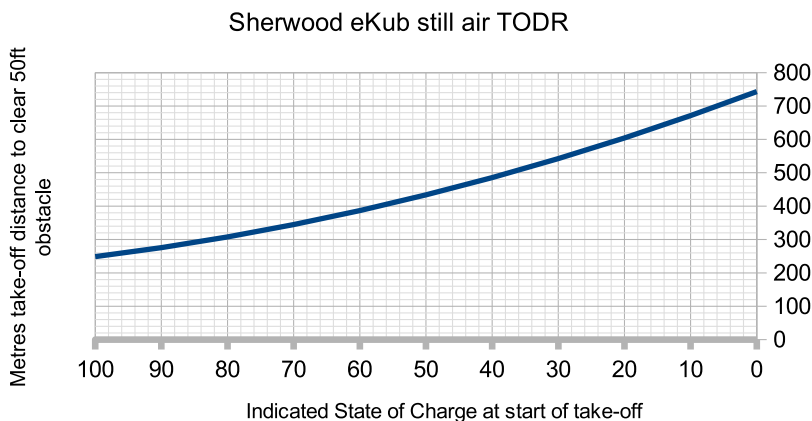

Figure 12. Sherwood eKub standardised take off distance required (MTOM, still air, hard runway, ISA sea-level conditions) values below 36% SoC indicative only.

condition factors in Ref. [26] as applied to TOD. After considerable experimentation it was concluded that with the data available for this experiment was of insufficient quality to accurately divide between take-off roll and take-off distance, due to the 0.2Hz data resolution provided by SkyDemon, combined with the relatively short time of the entire take-off (typically in the order of 10–13s for the ground roll, and 3–12s for the airborne segment). Therefore, whilst the spacial trajectory output was trusted, the time breakdown was not, especially determination of the point in time where the aircraft left the ground. Thus it was concluded that this data was valid for determining TOD, but could not be trusted for determining TOR.

In accordance with normal aviation practices, this curve was then modified by reference to wind, temperature, slope, surface type and condition. It would normally be appropriate also to modify by reference to aeroplane weight but in practice this aircraft will only ever be operated very close to MTOM, and thus that correction was unnecessary. This is shown in Fig. 12.

3.3 Defining minimum state of charge for safe take-off (SoC_{MTO})

A problem identified during this project, and indeed which appears to have been identified by other projects such as the world's only certified electric aeroplane the Pipistrel Velis Electro which carries a cockpit placard prohibiting take-off with less than 50% SoCi, is the question of what what point does the degrading SoC become such that a take-off should no longer be attempted. One approach of course is that the data such as has been described and shown above should be provided, with which pilots are then equipped to make their own rational decisions based upon their trained skill and knowledge. However multiple precedents exist, including in BCAR Section S⁽²⁷⁾, the UK's airworthiness standard for microlight aeroplanes, which requires at S65 Climb that "The time for climb from leaving the ground up to 1,000ft above the field must be determined and when corrected for sea level, must not exceed four minutes". Similarly, in CS.23², which is the airworthiness standard that would apply to larger aeroplanes it is a requirement of CS.23.65 that "Each normal, utility and aerobatic category reciprocating engine powered aeroplane of 2,722kg (6,000lb) or less maximum weight must have a steady gradient of climb at sea level of at-least 8.3% for landplanes". Both contain further qualifying instruction, that aren't relevant to this project. A climb gradient of 8.3% corresponds to 4.74° climb angle. Therefore it was considered appropriate to recommend that climb rate from ISA sea-level to 1,000ft, and climb gradient are both determined and that for microlight aeroplanes (up to 600kg MTOM and 45kts V_{SO}) the first requirement should determine minimum SoC for take-off, and for light aeroplanes (exceeding 600kg MTOM and/or 45kts V_{SO} , up to 2,722kg and/or 61kts V_{SO} for single engine aeroplanes) the sea level climb gradient should inform the minimum SoC for take-off. This is the recommendation of this paper,

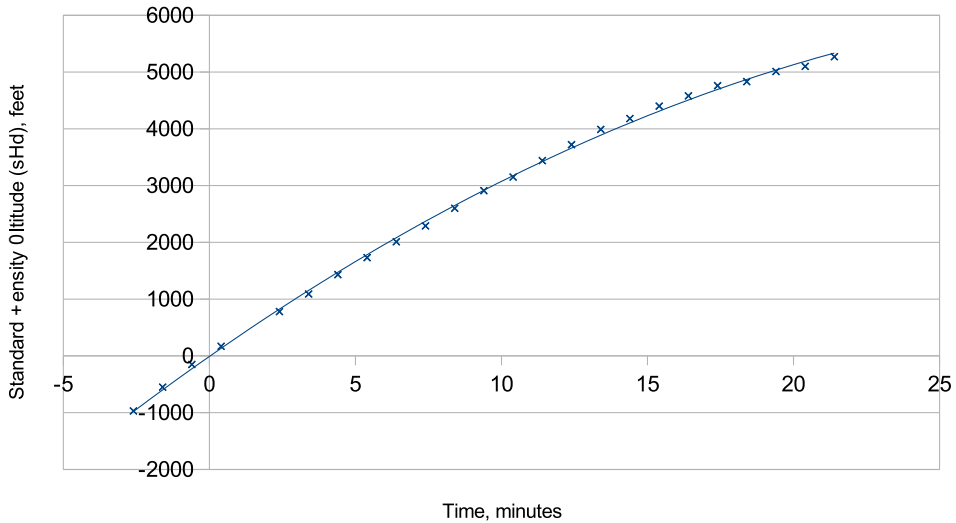

Figure 13. Sherwood eKub climb performance at full throttle, from -970ft standard density altitude. Best fit quadratic curve to raw data recorded by test pilot.

and was the internal decision made for the Sherwood eKub but, at time of writing, is not incorporated in any regulations.

Before proceeding with this, it was helpful to confirm that the aeroplane was capable of meeting such requirement at-all. In sortie 18, flown on 17 January 2023 the aeroplane was climbed at 625lb (95% MTOM), OAT-3°C (ISA-18), QFE 978, with an initial 100%SoCi from 1,000ft sHp (surface level at 1,013hPa) to 7,240ft (end of climb 35%SoCi). Reducing to standard density altitude, and extrapolating down to sea-level using a quadratic best fit, this gave the results shown in Fig. 13. The aeroplane started at a take-off from -970ft sHd and 100% SoCi, and climbed through 0ft at about 91% SoC, with the subsequent 1,000ft climb being performed in 3.1 minutes, comfortably exceeding the minimum requirement.

The problem then is of scaling this to varying values of SoC without having to perform multiple performance climbs. This was done by scaling from the SkyDemon obtained flight test data, using the time to 300ft, which was a convenient marker as it was take-off until immediately before the first turn. At first approximation we were able to fit a linear fit to that which was that RoC from runway to 300ft was $RoC = 2.841SoC_1 + 174$ feet/minute. Scaling that linearly to the time to 1,000ft (compared to the 90% SOCi at $t=0$ result in Fig. 7, this gave the result in Fig. 8, from which the conclusion is that the aeroplane can meet the 1,000ft initial climb requirement at or above $SoCi=57%$ (Fig. 14). The decision for this aeroplane, for which microlight regulations are most appropriate therefore was that in the manual and on a placard the words “Take-offs not recommended below 57% SoC” would be included. (This corresponds to 59% SoCt.)

Coining a term for this, $SoCi_{MTO}=57%$ for compliance with BCAR Section S

Treating the eKub alternately as if it were a part 23 aeroplane up to 2,722kg however requires slightly different treatment. Using the mean climb rate from 0 to 1,000ft sHd, and the eKub’s best climb speed of 45kts CAS, a climb gradient chart is readily plotted; time to climb is shown in Table 4 and Fig 13, and then a derivative gradient chart in Fig. 15. Based upon this, were this a part 23 aeroplane, with the requirement that the climb gradient at standard conditions should be not worse than 8.3% the minimum SoCi for take-off would be 72% (corresponding to 73% SoCt). This is a large value, but not an unrealistic one – given that electric aeroplanes are inevitably limited in total capacity in any case (the eKub has demonstrated, flown economically a total endurance of 70 minutes without reserves, and this may make it one of the best aeroplanes in the world in that regard), and save for training circuits it is unlikely that many flights would be launched with a lower state of charge.

Applying the same term as above, $SoCi_{MTO}=72%$ for compliance with part 23.

Table 4. Raw cockpit recorded flight test data

Take-off No.	SoCt (%)	System voltage (V)	Battery core temp (°C)	Motor core temp (°C)	IAS at unstick (mph)	IAS at 50ft (mph)
1	99	57	27	34	NR	55
2	90	56	31	37	50	55
3	82	55	34	36	50	55
4	76	54	35	35	48	55
5	69	54	38	36	50	55
6	62	NR	NR	NR	50	55
7	55	52	41	35	50	55
8	47	51	43	35	50	55
9	37	50	45	35	50	55

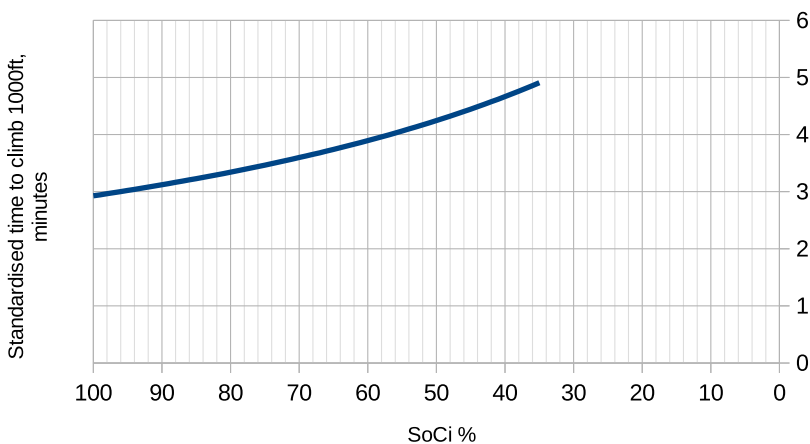

Figure 14. eKub standardised time to climb from 0 to 1,000ft standard density altitude.

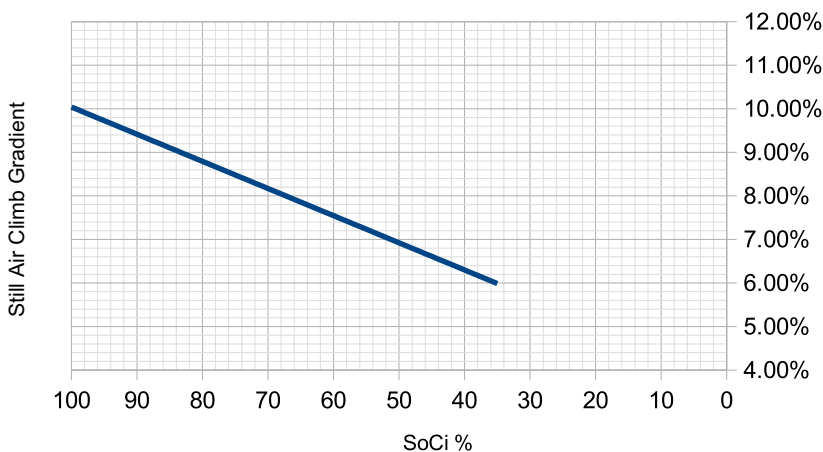

Figure 15. eKub standardised climb gradient between 0 and 1,000ft sHd versus SoC₁.

4.0 The future work needs

The concept of TAFT has been shown highly beneficial in considering the take-off and full throttle climb performance of a battery-electric aeroplane. However, it has no physical significance and has multiple contributory factors including battery voltage and motor temperature. It would be beneficial for future work to unpick this concept, and it may prove that separate consideration of component factors, and abandonment of TAFT as a concept, may prove best.

The work herein represents, the authors believe, the first published work on the determination of battery-electric aeroplane take-off and full throttle climb performance. However at this stage it is not incorporated into regulations, and this will be a necessary next step before it can have true utility for the aircraft design, test and certification communities.

With regard to the data acquisition methods used, the use of the SkyDemon tool combined with Google Earth as an analysis tool was very beneficial in permitting determination of take-off performance; however the 0.2Hz time resolution used by SkyDemon whilst acceptable when determining the spacial trajectory made it impossible to determine the precise split between the ground roll and airborne segment, particularly given the very short (typically 15–25s) period between brakes off and 50ft in this aeroplane. That would be less problematic with aeroplanes that have a slower and longer take-off run, but in general there would be significant advantage in any future research of this nature using a GPS tool that records at a rate of 1Hz or better.

This work was all carried out with a new aeroplane, and by the end of the programme the total time run on the powertrain was under 50hrs. Thus there was no known reduction in system maximum capacity through the research, which is widely termed battery SoH. It is highly likely that future work will wish to start modelling SoH and its impact upon aeroplane performance.

5.0 Conclusions

Determining the take-off and initial climb performance of a battery-electric aeroplane can be done, but requires consideration of additional factors, beyond those normally required. In all cases this must include the available maximum thrust at a given SoC. If carrying out a theoretical analysis, the concept of TAFT is probably the simplest tool for modelling the reduction in maximum thrust over short periods of time, and thus the impact upon take-off and full throttle climb performance. Modelling will need to incorporate reduction in maximum thrust with time, and it is likely unsafe to assume constant thrust, except where a degraded setting is in use and managed to ensure constant below-maximum thrust. TAFT itself, whilst a valuable concept, doesn't have any immediate physical significance and is contributed to by multiple factors which as a minimum are likely to include motor temperature and battery voltage, and potentially inverter temperature and control software scheduling, therefore future work may wish to eliminate TAFT and replace it with multiple factors of physical significance.

A further implication of TAFT is in piloting technique. Pilots are trained that if an obstacle is descending within their field of view whilst climbing (e.g. whilst trying to outclimb a take-off obstacle) it will not be a threat to the aircraft. However with climb performance degrading with time, this cannot be relied upon and pilots of battery-electric aeroplanes must be advised to rely upon published climb performance data, and not visual clues, when trying to outclimb obstacles.

As with all aeroplanes, ultimately take-off performance must be determined through flight test. This can be done in the same way as for any other aeroplane, with GPS or external measurement methods. However, the introduction of an additional factor is essential, which is battery SoC, for battery-electric powertrain aeroplanes. This could conceivably be rendered unnecessary by deliberate management of powertrain output, but doing so would at higher states of charge be significantly degrading the available take-off performance (with the eKub if the powertrain was, for example, degraded to the level equivalent to minimum SoC recommended for take-off, this would increase TODR at 100% SoC by 80%, and create a significant restriction upon operations).

This work has also identified that when the two concepts of regulations requiring a minimum climb performance or gradient, and take-off and climb performance in a battery electric aeroplane degrading with use of battery charge, are combined – this has potential to create the need for the concept of a minimum state of charge for take-off: $SoCi_{MTO}$. The eKub would require this concept for compliance with either BCAR Section S (where it was found that $SoCi_{MTO}=57\%$) and with part 23 (where it was found that $SoCi_{MTO}=72\%$).

Acknowledgements. This paper originates in project EnabEl, which is a collaboration of Cranfield University, The Light Aircraft Company, Flylight Airports and CDO². This project aims to learn how to design, build, test, certify and operate electric aeroplanes.

EnabEl was funded by Innovate UK under project 70618, funded at phase 2 of the Future Flight Challenge. The photograph at Fig. 1 was kindly provided by Keith Wilson, who took it during a flight test session for Pilot Magazine. The test aircraft is owned by The Light Aircraft Company (TLAC) whose ongoing participation in this project is gratefully appreciated.

Author contributions. All authors contributed to and approved the text; all authors were active participants in the EnabEl project and fed into planning, testing and analysis. Gratton, however, led the project, the writing of this paper, and the test flying, therefore is named as first author.

References

- [1] European Union Aviation Safety Agency, Certification Specification and Acceptable Means of Compliance for Light Sport Aeroplanes, CS-LSA Amendment 1 dated 30 July 2013.
- [2] European Union Aviation Safety Agency, Certification Specification and Acceptable Means of Compliance for Normal, Utility, Aerobatic and Commuter Category Aeroplanes, CS-23 issue 5 Amendment 3 dated June 2023.
- [3] Federal Aviation Administration, Airworthiness Standards: Normal Category Airplanes, 14 CFR part 23 Amdmt 23-64 dated 30 Dec 2016.
- [4] Federal Aviation Administration, Flight Test Guide for Certification of Part 23 Airplanes, Advisory Circular No. 23-8C dated 16 Nov 2011.
- [5] Zaghari, B. et al., The impact of multi-stack fuel cell configurations on electrical architecture for a zero emission regional aircraft, Proceedings of AIAA SCITECH 2023 Forum, 23-27 January 2023, available at <https://doi.org/10.2514/6.2023-1593>
- [6] Zaghari, B. et al., The impact of electric machine and propeller coupling design on electrified aircraft noise and performance, Proceedings of the AIAA SCITECH 2023 Forum, 23-27 January 2023, available at <https://doi.org/10.2514/6.2023-2133>
- [7] Zaghari, B., Zhou, T., Enalou, H.B., and Laskaridis, P. (2023). Integrated mission performance analysis of novel propulsion systems: Analysis of a fuel cell regional aircraft retrofit. In AIAA SCITECH 2023 Forum (p. 0840 <https://arc.aiaa.org/doi/abs/10.2514/6.2023-0840>)
- [8] Zhou, T. Minimising the effect of degradation of fuel cell stacks on an integrated propulsion architecture for an electrified aircraft, Proceedings of the 2007 IEE International Conference on Industrial Engineering and Engineering Management, available at <https://ieeexplore.ieee.org/abstract/document/9813899>
- [9] Fichtner, M. et al. Rechargeable batteries of the future – the state of the art from a battery 2030+ perspective, *Adv. Energy Mater.*, 2022 **12**, (17), available at <https://doi.org/10.1002/aenm.202102904>
- [10] Bird, J.Z. A review of electric aircraft drivetrain motor technology, *IEEE Trans. Magnetics*, 2022, **58**, (2), pp 1–8, Art no. 8201108, doi: [10.1109/TMAG.2021.3081719](https://doi.org/10.1109/TMAG.2021.3081719)
- [11] van Heerden, A.S.J. et al. Aircraft thermal management: practices, technology, system architectures, future challenges, and opportunities, *Progress Aerospace Sci.*, 2022, **128**, p 100767, ISSN 0376-0421, Available at <https://doi.org/10.1016/j.paerosci.2021.100767>
- [12] Roggia, S. et al. Things flight testers should know about electric engines, Proceedings of the 2023 Symposium of the Society of Flight Test Engineers (Maryland, Oct 2023), available at <https://aerotec.com/things-flight-testers-should-know-about-electric-engines/>
- [13] Yang, X.G. et al. Challenges and key requirements of batteries for electric vertical takeoff and landing aircraft, *Joule*, 2021, **5**, (7), pp 1644–1659, available at <https://doi.org/10.1016/j.joule.2021.05.001>
- [14] Paw, Y.C. and Ang, E.Y.M. Battery cycle life assessment for a Lift+Cruise electric vertical takeoff and landing transporter drone, *J. Energy Storage*, 2023, **66**, p 107493, available at <https://doi.org/10.1016/j.est.2023.107493>
- [15] Bills, A. et al. A battery dataset for electric vertical takeoff and landing aircraft, *Sci. Data*, 2023, **10**, p 344, available at <https://doi.org/10.1038/s41597-023-02180-5>
- [16] Haglade, J.M. and Brown, T.W. NASA Electric Aircraft Testbed (NEAT) reconfiguration to enable altitude testing of megawatt-scale electric machines, 2020 AIAA/IEEE Electric Aircraft Technologies Symposium (EATS), New Orleans, LA, USA, 2020, pp 1–13, available at <https://ieeexplore.ieee.org/abstract/document/9235179>
- [17] Doulgeris, S. et al. Assessment and design of real world driving cycles targeted to the calibration of vehicles with electrified powertrain, *Int. J. Engine Res.*, 2021, **2**, (22), p 12, available at <https://doi.org/10.1177/14680874211038729>
- [18] Tran, M.-K. et al. Design of a hybrid electric vehicle powertrain for performance optimization considering various powertrain components and configurations, *Vehicles*, 2021, **3**, pp 20–32, available at <https://doi.org/10.3390/vehicles3010002>

[19] Hogge, E.F. et al. Flight tests of remaining time prediction system for small electric aircraft in the presence of faults, Proceedings of the annual Conference of the Prognostics and Health Management Society (PHM), 2017, available online at <https://ntrs.nasa.gov/citations/20170010145>

[20] Unwin, D. Electrifying fun – the eKub, Pilot Magazine, 2023, pp 1,18–26; ISSN 9-770300-169240-08

[21] Unwin, D. It has Potential, Flight test: TLAC Sherwood EKUB, Microlight Flying, 2023, pp 34–38+45. <https://uavionix.com/products/av-30/>

[22] US Federal Aviation Administration, FAA Specification for Wind Cone Assemblies, AC 150/5345-27E Dated 26 Sept 2013. <https://www.skydemon.aero/>

[23] Gratton, G.B. Use of Global Positioning System velocity outputs for determining airspeed measurement error, *Aeronaut. J.*, 2007, **111**, (1120), pp 381–388.

[24] UK Civil Aviation Authority, Aeroplane Performance, Safety Sense Leaflet No.7c, January 2013.

[25] UK Civil Aviation Authority, British Civil Airworthiness Requirements Section S: Microlight and Small Light Aeroplanes, CAP 482 Issue 8 15 May 2023.

Appendix A. The field performance section of the Sherwood eKub Pilots Operating Handbook, prepared as a result of this research.

The following graph shows the take-off distance in still air to clear a 50ft obstacle. This is based upon take-off from a dry level runway at sea level, leaving the ground at 50mph IAS and climb through 50ft at 55mph IAS. The upper, green, curve is for departures from short dry grass surfaces, the lower, black, curve from a hard surfaces.

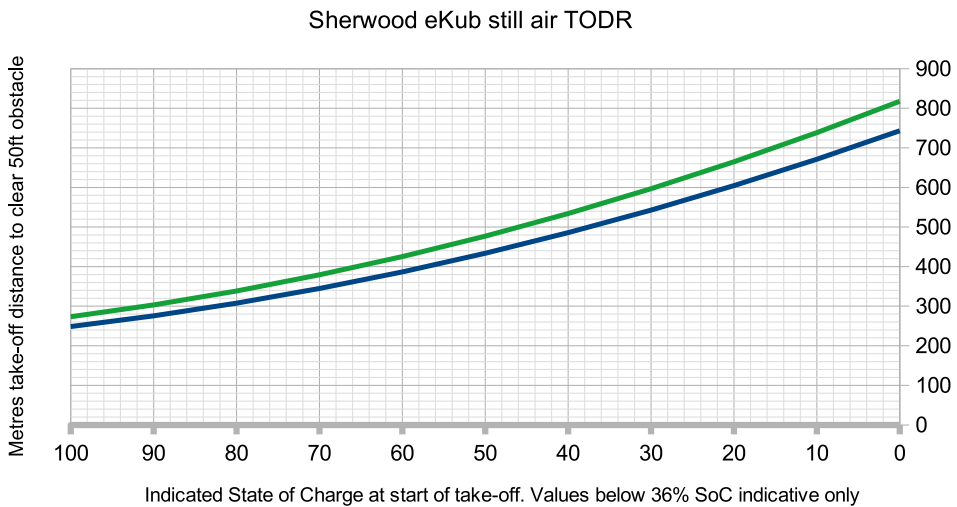

These values are in still air and should be modified as follows for real conditions:-

	Multiply by	Divide by
Per 1000ft airfield elevation above sea level	1.10	
Per 10°C temperature above 15°C	1.1	
Per 5kts headwind		1.11
Per 5kts tailwind	1.22	
Per 2% uphill slope	1.10	
Recommended additional safety factor	1.33	

So, for example a take-off from a dry grass runway 500ft above sea level, at 25°C with a 10kt headwind, with 80% SoC requires the following calculation:-

$$\begin{aligned} \text{TODR} &= 340\text{m basic} \\ &\times 1.05 \text{ for airfield elevation} \\ &\times 1.10 \text{ for temperature} \\ &\div (1.11 \times 1.11) \text{ for headwind} \\ &= 319\text{m.} \\ &\times 1.33 = 424\text{m} \end{aligned}$$

Therefore the take-off distance from brakes off to 50ft = 319m, but it is recommended that you allow a minimum runway length of 424m.

Because of the reduced climb performance at low states of charge, it is recommended that take-offs are not carried out below 57% SoC.