

The Potts model representation and a Robinson–Schensted correspondence for the partition algebra

P. P. MARTIN and G. ROLLET

Department of Mathematics, City University, Northampton Square, EC1V 0HB, London UK

Received 18 June 1996; accepted in final form 28 April 1997

Abstract. We construct a correspondence between the set of partitions of a finite set M and the set of pairs of walks to the same vertex on a graph giving the Bratteli diagram of the partition algebra on M . This is the precise analogue of the correspondence between the set of permutations of a finite set and the set of pairs of Young tableaux of the same shape, called the Robinson–Schensted correspondence.

Mathematics Subject Classification (1991): 05E10 (cross reference 82B20).

Key words: Potts model, invariant theory, Robinson–Schensted correspondence, partitions of sets

1. Introduction

Let us recall Section V.5 of Herman Weyl’s wonderful book *The Classical Groups* [25]. There Weyl illustrates two constructions of classical invariant theory. He first pictures the elements of the symmetric group as being all possible heterosexual pairings of a row of ‘male’ symbols (Weyl’s inverted commas) with an equinumerate row of ‘female’ symbols. The group product is realized by juxtaposing two such permutations and contracting each *ménage* $(i_{\text{male}}, j_{\text{female}})(j_{\text{male}}, k_{\text{female}})$ into $(i_{\text{male}}, k_{\text{female}})$, as illustrated in Figure 1.

Weyl shows how, for n symbols of each sex, this picture lends itself to the interpretation of a quotient of the symmetric group algebra $\mathbb{C}S_n$ as the centralizer algebra $\text{End}_{\mathfrak{gl}(V)}(V^{\otimes n})$ (V a \mathbb{C} -space, of dimension d say; $\mathfrak{gl}(V)$ the general linear group). He then points out that a basis of the larger centralizer algebra $\text{End}_{\mathfrak{O}(V)}(V^{\otimes n})$ ($\mathfrak{O}(V)$ the orthogonal group), may again be built from pairings amongst rows of males and females, but in the case where homosexual pairing is also possible, or as Weyl put it ‘without any discrimination of “sex”’. The other new feature is that in juxtaposition of basis elements, s and t say, there can appear connected clusters (closed under transitive extension of pairing) with no representative in the exterior. Let $n(s, t)$ be the number of such clusters, and let $s \bullet t$ be the basis element obtained by combining s with t and discarding these

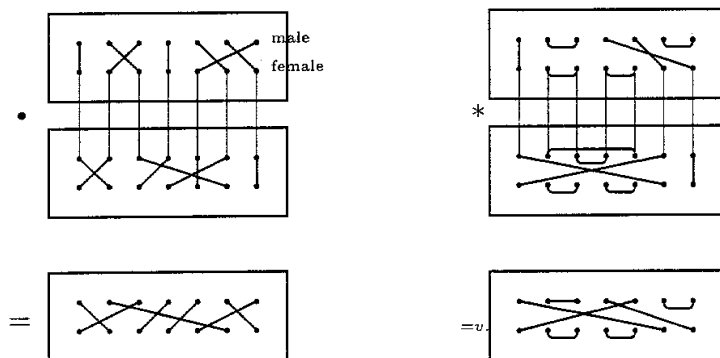

Figure 1. Symmetric group multiplication. Figure 2. Brauer algebra multiplication.

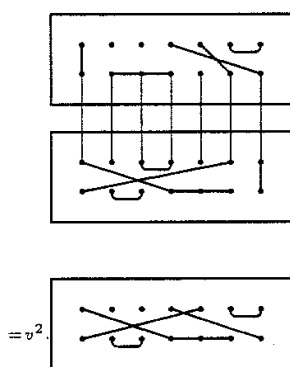

Figure 3. Partition algebra composition.

clusters. Then, for v an indeterminate, an algebra multiplication $*$ may be given by $s * t = v^{n(s,t)} s \bullet t$ (see Figure 2). This defines the abstract *Brauer algebra* $J_n(v)$ [3] which is, say, a $\mathbb{Z}[v]$ -algebra, not a group. When $v \mapsto d = \dim(V)$ it has an action on $V^{\otimes n}$ which centralizes that of $\mathfrak{S}(V)$.

If Weyl had pursued his colourful image, the next step, at least while restricted to two sexes, could have been to countenance gatherings of males and females without discrimination of sex or *quantity* of partners (that is, simply all partitions of the set of males and females). Possible such gatherings are illustrated in Figure 3 (note that the representation of a gathering is not unique here), and in fact the composition illustrated in Figure 3 brings us to the abstract *partition algebra* $P_n(v) \supset J_n(v)$ [16]. This is a still larger algebra with an action on $V^{\otimes n}$, in case $v \mapsto d$. The action is called the ‘Potts representation’ [11, 8] – see Section 2. Note that the symmetric group S_d may be regarded as a subgroup of the orthogonal group $\mathfrak{O}(V)$, acting by permutation of standard ordered basis elements in V . Then the action of $P_n(d)$ centralizes the action of S_d diagonally on $V^{\otimes n}$.

In the present paper we examine this new *Weyl duality* between the partition algebra $P_n(d)$ and the symmetric group S_d . It is interesting from a physical point of view, as we will discuss later, and also induces some interesting combinatorial results (cf. James and Kerber [6] p. 231), involving graphs characterized via S_d representation theory on the one hand, and Bell and Stirling numbers on the other. This data is best organized as a correspondence of Robinson–Schensted type.

1.1. ON CORRESPONDENCES OF ROBINSON–SCHENSTED TYPE

For G an algebra over \mathbb{C} with countably many finite dimensional simple modules let \overline{G} denote an index set for these simples. For example, defining Γ_d to be the set of Young diagrams of d boxes (i.e. the set of dominant weights of degree d , thus $\Gamma_2 = \{(2), (1, 1)\}$ and so on) we may take $\overline{\mathbb{C}S_d} = \Gamma_d$. Let \mathcal{A}_* be a sequence $\mathcal{A}_1 \subset \mathcal{A}_2 \subset \cdots \subset \mathcal{A}_l$ of finite dimensional semi-simple algebras over \mathbb{C} . The Bratteli diagram for \mathcal{A}_* is an oriented graph whose point set is the disjoint union of index sets for all the simple modules, $\dot{\bigcup}_i \overline{\mathcal{A}}_i$, and where (a, b) is an edge of multiplicity m if simple with index a is an m -fold direct summand of the restriction of simple with index b from \mathcal{A}_k to \mathcal{A}_{k-1} (some k) [4].

Let $\mathcal{A}_*, \mathcal{B}_*$ be two sequences as above, of length l and l' respectively. We say \mathcal{B}_* is a *refinement* of \mathcal{A}_* if $\{\mathcal{A}_i | i = 1, 2, \dots, l\} \subset \{\mathcal{B}_i | i = 1, 2, \dots, l'\}$. A *refined* Bratteli diagram for an algebra \mathcal{A} is a Bratteli diagram for some sequence \mathcal{A}_* of length l in which $\mathcal{A}_1 \cong \mathbb{C}$ (we take $\overline{\mathcal{A}}_1 = \{e\}$), $\mathcal{A}_l = \mathcal{A}$, and each edge has multiplicity at most 1. Note that if an algebra \mathcal{A} has a refined Bratteli diagram then the dimension of simple L_b , with index $b \in \overline{\mathcal{A}}$, is the number of ‘forward’ walks on the diagram from e to b . By elementary representation theory considerations $\dim(\mathcal{A}) = \sum_{b \in \overline{\mathcal{A}}} (\dim(L_b))^2$ and this implies a bijection between any basis of \mathcal{A}_l and the set of pairs of walks to the same vertex. If we have an infinite sequence of algebras such that truncation at any finite l gives a refined diagram; and if each \mathcal{A}_l has a natural basis (e.g. the group in the case of a group algebra); then a construction for an explicit bijection with the natural basis which works for all l will be called a *Robinson–Schensted correspondence for \mathcal{A}_** . Note that the *existence* and *construction* of a correspondence are in principle entirely separate problems!

For example, consider $\mathcal{A}_i = \mathbb{C}S_i$. Then the Bratteli diagram for the sequence $\mathcal{A}_1 \subset \mathcal{A}_2 \subset \cdots \subset \mathcal{A}_l$ is refined for any l . Walks in this case are standard Young tableaux (since these simply record paths on the $\mathbb{C}S_*$ Bratteli diagram). Recall that the original Robinson–Schensted correspondence constructs a bijection between the elements of the symmetric group and pairs of standard tableaux of the same shape. The *existence* of such a bijection is a consequence of Young’s original analysis of S_n circa 1930 [26] (see also Rutherford [21]), but representation theory alone does not *construct* any bijection, and indeed no candidate for a construction appeared until Robinson [19], and it was not until Schensted [22] that a workable version was developed. The subsequent uses of the correspondence have been

manifold – see for example Knuth [9], Date *et al.* [14], Stanton and White [23], Kirillov [15].

The Bratteli diagram for sequences with $\mathcal{A}_i = P_i(v)$ is *not* refined in general. However there is a natural refinement. The representation theory of the partition algebra $P_n(v)$ then implies the existence of a bijection between its canonical basis (the set of partitions of $2n$ objects) and walks on this refined partition algebra Bratteli diagram, which we construct in Section 1.3. Indeed representation theory shows that a bijection exists respecting the various quotients $\text{End}_{S_d}(V^{\otimes n})$, i.e. between partitions into d parts on the one hand, and a suitably truncated representation theory (see Section 2) on the other. In this paper we construct such a correspondence (Section 3). This has several applications, some of which we mention in the discussion. We recall some key definitions and results from [12] in Section 1.2.

We can anticipate that walks on the Bratteli diagram for an arbitrary sequence of algebras, even if refined, are not as easily characterized as those for the symmetric group. We conclude this section by considering a class of sequences of algebras (including the partition algebras) which have, by construction, a natural organisational scheme for walks.

Suppose that G is a bialgebra with countably many finite dimensional simples. Let \mathcal{C} be a category of semi-simple finite dimensional G -modules, closed under tensor product. Suppose $V \in \mathcal{C}$, and that there exists simple $R_o \in \mathcal{C}$ such that $V \otimes R_o \cong V$, and consider $\mathcal{A}_i = \text{End}_G(V^{\otimes i-1})$ (and take $V^{\otimes 0} := R_o$). Then by construction $\mathcal{A}_i \subset \mathcal{A}_{i+1}$ and this gives us a ready supply of sequences of algebras to play with (not necessarily refined). In particular we have seen that in case $G = \mathbb{C}S_d$, with V as in the previous section ($\dim(V) = d$), the centralizer algebras are quotients of the partition algebras $P_n(d)$.

Suppose further that $V \otimes R_a = \bigoplus_{b \in \overline{G}} M_{ab} R_b$ gives the simple content of the product of V with simple R_a , $a \in \overline{G}$ and that the matrix $(M_{ab})_{a,b \in \overline{G}}$ is symmetric (for example, as if G is a finite group algebra and V is self-contragredient). By construction $\overline{\mathcal{A}_i} \hookrightarrow \overline{G}$, and so walks on the undirected graph with incidence matrix (M_{ab}) are in correspondence with forward walks on the Bratteli diagram of \mathcal{A}_* . Moreover, if $F \subset G$ is a subalgebra with the same properties then $\text{End}_F(V^{\otimes i}) \supset \text{End}_G(V^{\otimes i})$. If in addition $\text{End}_F(V^{\otimes i-1}) \hookrightarrow \text{End}_G(V^{\otimes i})$ (for example if F, G are finite group algebras and $V = G \otimes_F V_0$ where V_0 is the trivial F -module) then we may make a refinement of \mathcal{A}_* by inserting at each i : $\mathcal{A}_i \subset \text{End}_F(V^{\otimes i-1}) \subset \mathcal{A}_{i+1}$. Again by construction, walks on an undirected graph with vertices $\overline{G} \cup \overline{F}$ will encode walks on the new Bratteli diagram. In case the new diagram is refined this new undirected graph will be called its *shadow* graph in the following. For example, we will see that putting $F = \mathbb{C}S_{d-1}$ leads to a refinement of the partition algebra example discussed above.

In particular, let \mathfrak{G}_d be the bipartite graph with point set $\Gamma_d \cup \Gamma_{d-1}$ and (λ, ν) an edge of \mathfrak{G}_d iff $\lambda = \mu \pm \square$ as Young diagrams. For example \mathfrak{G}_4 is:

$$(4) \Leftrightarrow (3) \Leftrightarrow (3, 1) \Leftrightarrow (2, 1) \Leftrightarrow (2, 1, 1) \Leftrightarrow (1, 1, 1) \Leftrightarrow (1, 1, 1, 1).$$

$$\begin{array}{c} | \\ (2, 2) \end{array}$$

We will see that \mathfrak{G}_d is a shadow graph for the diagram of a quotient of the partition algebra $P_n(d)$. Now for \mathcal{G} a graph and μ, ν vertices of \mathcal{G} let $D_{\mu, \nu}^{\mathcal{G}}(n)$ be the set of walks on \mathcal{G} of length n from μ to ν . Let $S(n, i)$ be the *Stirling number of the second kind*, which is the number of ways of partitioning a set of degree n into exactly i parts. Then we find that $|D_{(d), (d)}^{\mathfrak{G}_d}(2n)| = \sum_{i=1}^d S(n, i)$, which for $d > n$ gives the n^{th} *Bell number* $B_n := \sum_{i=1}^n S(n, i)$. For example $|D_{(4), (4)}^{\mathfrak{G}_4}(6)| = 5$. In this paper several such identities are established in the algebraic context, as a trivial corollary of the R-S correspondence for the partition algebra (see equation (6)).

1.2. BASIC DEFINITIONS

- (1) We denote the rows of males and females by $\underline{n} := \{1, 2, \dots, n\}$ and $\underline{n}' := \{1', 2', \dots, n'\}$ respectively.
- (2) For M a set, \mathbb{E}_M is the set of equivalence relations on M , or equivalently the set of partitions of M into disjoint subsets.
- (3) For k a field we write $k\mathbb{E}_M$ for the free k module with basis \mathbb{E}_M . Thus for $u \in k$ the partition algebra (on n pairs) $P_n = P_n(u)$ is $k\mathbb{E}_{\underline{n} \cup \underline{n}'}$, with product as in Figure 3 (with $v \mapsto u$).
- (4) The function $\#^P : \mathbb{E}_{\underline{n} \cup \underline{n}'} \rightarrow \mathbb{N}$ is given by $\#^P(x) =$ the number of equivalence classes of x containing both primed and unprimed elements. For example, defining partitions

$$A^{i\cdot} = \{\{1, 1'\}, \{2, 2'\}, \dots, \{i\}, \{i'\}, \dots, \{n, n'\}\} \quad \text{and}$$

$$A^{ij} = \{\{1, 1'\}, \{2, 2'\}, \dots, \{i, j, i', j'\}, \dots, \{n, n'\}\}$$

then $\#^P(A^{i\cdot}) = \#^P(A^{ij}) = n \Leftrightarrow 1$.

- (5) For given n we write \mathbb{E} for $\mathbb{E}_{\underline{n} \cup \underline{n}'}$, and for $i = 0, \dots, n$

$$\mathbb{E}[i] := \{x \in \mathbb{E} \mid \#^P(x) = i\} \quad \text{and} \quad \bar{\mathbb{E}}[i] := \{x \in \mathbb{E} \mid \#^P(x) \leq i\}.$$

- (6) Then $k\bar{\mathbb{E}}[i] \supset k\mathbb{E}[i \Leftrightarrow 1]$ is an inclusion of $P_n(u)$ ideals and $\mathbb{E}[i]$ is a basis for the i th section with respect to this filtration, which we call $P_n[i]$.

- (7) Furthermore in characteristic 0 and for $u \neq 0$ (as we assume hereafter in this paper) there exist idempotents $e_i = \prod_{j=1}^{n-i} \frac{A^j}{u}$ such that

$$P_n(u)e_iP_n(u) = k\bar{\mathbb{E}}[i]$$

(we take $e_n = 1$) and

$$e_i P_n(u) e_i \cong \mathbb{C} S_i, \quad \text{mod } k\mathbb{E}[i \leftrightarrow 1],$$

which shows that an index set for simple left modules $\mathcal{S}_\lambda^u(n)$ of $P_n(u)$ is

$$\tilde{\Gamma}_n := \{\lambda \vdash i \mid i = 0, 1, 2, \dots, n\} = \bigcup_{i=0}^n \Gamma_i.$$

(8) $P_{n+}(u)$ is the subalgebra of $P_{n+1}(u)$ in which the $(n+1)$ th male and the $(n+1)$ th female are always in the same cluster. We write $P_n(u) \subset P_{n+}(u)$ for the embedding which associates to a diagram in $P_n(u)$ a diagram in $P_{n+}(u)$ in which the cluster containing the $n+1$ st male and female does not contain any other members, and all other clusters are the same as in the original diagram.

(9) It is shown in [12] that the categories of left-modules $P_{n+}(u)\text{-mod}$ and $P_n(u \leftrightarrow 1)\text{-mod}$ are Morita equivalent. Thus the irreducible representations $\mathcal{S}_\lambda^u(n+)$ of $P_{n+}(u)$ may be indexed by the same set as the irreducible representations of $P_n(u)$, namely $\tilde{\Gamma}_n$. In order to distinguish them we append the symbol $+$ to the indices in the $P_{n+}(u)$ case, calling this index set $\tilde{\Gamma}_{n+}$.

(10) For v indeterminate, we define $\mathcal{S}_\lambda(n) = \mathcal{S}_\lambda^v(n)$ (in the following we will omit the n , when there is no ambiguity). Passing through a suitable $\mathbb{Z}[v]$ basis (see [17]) \mathcal{S}_λ is then also defined for any particular value u of v . In fact, when $u \notin \mathbb{N}$, $\mathcal{S}_\lambda = \mathcal{S}_\lambda^u$ still holds, that is \mathcal{S}_λ is generically simple, but if $u = d \in \mathbb{N}$, \mathcal{S}_λ can have a proper submodule, I_λ^d (in fact always simple if it exists, see [17]). Then one gets:

$$\mathcal{S}_\lambda^d = \mathcal{S}_\lambda / I_\lambda^d. \quad (1)$$

We will now calculate \mathcal{S}_λ dimensions using a Bratteli diagram. Note that elementary considerations give

$$|\mathbb{E}_{\underline{n} \cup \underline{n}'}| = B_{2n} = \sum_{\lambda \in \tilde{\Gamma}_n} (\dim \mathcal{S}_\lambda(n))^2.$$

1.3. THE BRATTELI DIAGRAM

(11) The formal infinite matrix U with row and column positions indexed by partitions (Young diagrams) ordered by degree and then lexicographically ([10] p. 5) is given by

$$U_{\lambda\mu} = \begin{cases} 1 & \lambda = \mu \\ 1 & \lambda = \mu + \square \\ 0 & \text{otherwise.} \end{cases}$$

where $+\square$ indicates adding a box to the diagram. Let U^\dagger denote the transpose of U .

PROPOSITION 1. *The matrices U and U^\dagger are the generic universal restriction matrices for generic simple modules \mathcal{S}_λ restricted via $P_{n+1} \supset P_{n+} \supset P_n$ respectively. That is*

$$P_{n+} \downarrow \mathcal{S}_\lambda(n+1) \cong \bigoplus_{\mu} (U)_{\mu\lambda} \mathcal{S}_\mu(n+) \quad \text{and} \quad P_n \downarrow \mathcal{S}_\lambda(n+) \cong \bigoplus_{\mu} (U^\dagger)_{\mu\lambda} \mathcal{S}_\mu(n)$$

(in non-semisimple cases the sums may not be direct, see [17]).

This is an obvious refinement of the case for restriction directly from P_{n+1} to P_n (see [16]).

For example, U begins

$$U = \begin{pmatrix} 1 & & & & & & & \\ 1 & 1 & & & & & & \\ 0 & 1 & 1 & & & & & \\ 0 & 1 & 0 & 1 & & & & \\ 0 & 0 & 1 & 0 & 1 & & & \\ 0 & 0 & 1 & 1 & 0 & 1 & & \\ 0 & 0 & 0 & 1 & 0 & 0 & 1 & \\ & & & & & & & \dots \end{pmatrix} \quad \text{basis labels :} \quad \begin{pmatrix} (0) \\ (1) \\ (2) \\ (1^2) \\ (3) \\ (2, 1) \\ (1^3) \\ \vdots \end{pmatrix}$$

which data converts to the generic simple module Bratteli diagram for $P_* := P_0 \subset P_{0+} \subset P_1 \subset P_{1+} \subset \dots$ shown truncated in Figure 4.

It follows that there is a R-S correspondence for the generic partition algebra in which the canonical basis is of partitions rather than permutations, and walks are on Figure 4 or on the corresponding shadow graph (see Section 2), rather than pairs of Young tableaux. But in fact there must be more structure. We will now show the existence of a correspondence filtered by *number of parts*.

2. The Potts representation

(12) For $d \in \mathbb{N}$ and $y \in \underline{d}$ the Potts- y representation of $P_{n+}(d)$

$$\mathfrak{R}_n^y : P_{n+}(d) \rightarrow \text{End}_{\mathbb{C}}(V^{\otimes n})$$

is defined as follows. The space $V^{\otimes n}$ has as basis the set of colourings of n sites by d colours, $\{v_f | f : \underline{n} \rightarrow \underline{d}\}$, and if $x \in \mathbb{E}$ the matrix for $\mathfrak{R}_n^y(x)$ in this basis is given by

$$(\mathfrak{R}_n^y(x))_{fg} = \begin{cases} 1 & i \sim^x j \Rightarrow f \cup g'(i) = f \cup g'(j) \\ 1 & i \sim^x k \Rightarrow f \cup g'(i) = y \quad i, j \notin \{n+1, n+1'\} \ni k, \\ 0 & \text{otherwise} \end{cases} \quad (2)$$

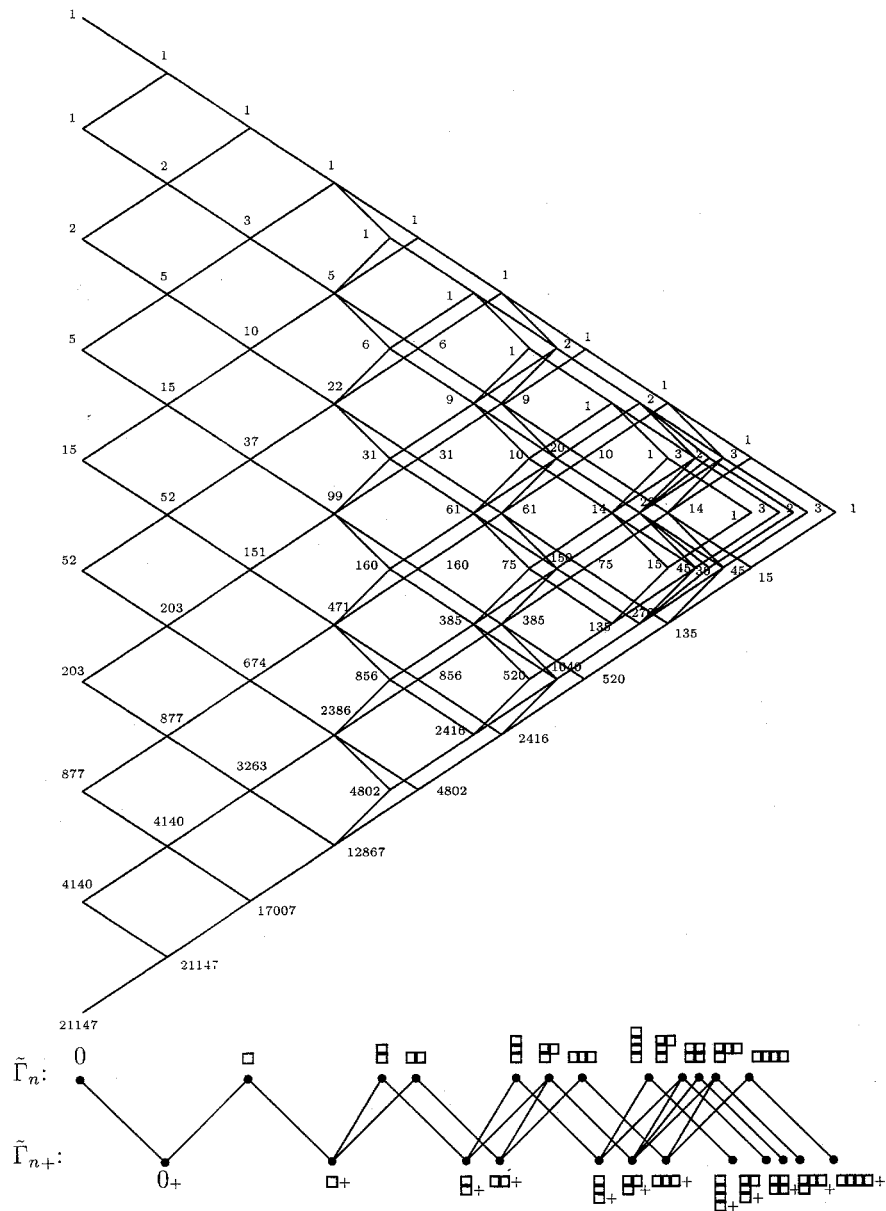

Figure 4. Part of the ‘Bratteli’ diagram for $P_0 \subset P_{0+} \subset P_1 \subset P_{1+} \subset P_2 \dots$ (to be precise, all restrictions of $\mathcal{S}_{(0)}(9)$), in which each \mathcal{S}_λ is represented by its dimension; and the corresponding part of the associated shadow graph – see equation (5) for ‘universal’ vertex labels.

where the subscripts f, g refer to the given basis, $f \cup g'$ has domain $\underline{n} \cup \underline{n}'$ and $g'(i') = g(i)$, i.e. $f \cup g'$ is a colouring of sites $\{1, 2, \dots, n, 1', 2', \dots, n'\}$. The conditions say that the f, g matrix element of $\mathfrak{R}(x)$ is 1 only if the colours of all

sites connected in x are the same, i.e. the elements of a class of x as an equivalence relation all have the same colour.

In particular all sites connected to ‘dummy’ site $n + 1$ have colour y . The colour y is the chosen ‘magnetic field direction’ (different y gives isomorphic representations).

(13) This restricts to the Potts representation \mathfrak{R}_n of $P_n(d)$.

(14) For d in \mathbb{N} , $\hat{P}_n(d)$ (resp. $\hat{P}_{n+}(d)$) is the image of $P_n(d)$ (resp. $P_{n+}(d)$) in the Potts representation [11] (resp. Potts- y representation).

PROPOSITION 2. For $d \in \mathbb{N}$

$$\hat{P}_n(d) \cong \text{End}_{S_d}(V^{\otimes n}), \tag{3}$$

$$\hat{P}_{n+}(d) \cong \text{End}_{S_{d-1}}(V^{\otimes n}). \tag{4}$$

Proof. These results are proved in a more general context in [12]. Here we give a shorter direct proof using an approach of Woodcock. Let T be an element of $\text{End}_{\mathbb{C}}(V^{\otimes n})$ expressed via matrix units in the colouring basis (corresponding to colourings of $\underline{n} \cup \underline{n}'$). For $G \subseteq S_d$ we have $T \in \text{End}_G(V^{\otimes n})$ iff $T_{f,g} = T_{wf,wg}$ for all $w \in G$. The S_d orbit of f, g is characterized by the partition it defines, thus

$$\dim(\text{End}_{S_d}(V^{\otimes n})) = \sum_{j=1}^d S(2n, j).$$

All such partitions appear in \mathbb{E} and the partial order \subseteq on \mathbb{E} allows us to construct the corresponding T ’s from equation (2), hence equation (3) is proven.

Let S_{d-1} act by permuting the first $d \Leftrightarrow 1$ colours, i.e. fixing colour d . The S_{d-1} orbits are indexed by partitions with a marked point (that containing colour d). All such appear in $P_{n+}(d)$ (the marked part is that containing $n + 1$). \square

(15) For $d \Leftrightarrow 1 \leq n$ define the set injection

$$\mathcal{I}: \Gamma_d \rightarrow \tilde{\Gamma}_n \tag{5}$$

by $(\mathcal{I}(\lambda))_i = \lambda_{i+1}$ (i.e. delete the first row of the Young diagram).

Note that this induces an injection of Γ_{d-1} in Γ_d (which adds one to the top row of a diagram), through which $D_{(d-1),(d-1)}^{\mathfrak{G}_{d-1}}(2n) \hookrightarrow D_{(d),(d)}^{\mathfrak{G}_d}(2n)$. For w an element of any of these walk sets we will write $\mathcal{I}(w)$ for the sequence in which each point in the walk is replaced by its image under \mathcal{I} . Thus $\mathcal{I}(D_{(d-1),(d-1)}^{\mathfrak{G}_{d-1}}(2n)) \hookrightarrow \mathcal{I}(D_{(d),(d)}^{\mathfrak{G}_d}(2n))$ is an inclusion.

(16) For r a positive integer the set of partitions of \underline{r} in d parts will be denoted $\mathbb{E}_{\underline{r}}^d$, and in $\leq d$ parts denoted $\mathbb{E}_{\underline{r}}^{\leq d}$. We also put $W_r^d := \mathcal{I}(D_{(d),(d)}^{\mathfrak{G}_d}(2r)) \setminus \mathcal{I}(D_{(d-1),(d-1)}^{\mathfrak{G}_{d-1}}(2r))$.

PROPOSITION 3 [12]. *The algebra $\hat{P}_n(d)$ (respectively $\hat{P}_{n+}(d)$) is semi-simple; for $n \geq d \Leftrightarrow 1$ the simple modules are those induced from the modules $\{\mathcal{S}_{\mathcal{I}(\lambda)}^d | \lambda \in \Gamma_d\}$ (respectively $\{\mathcal{S}_{\mathcal{I}(\lambda)}^d | \lambda \in \Gamma_{d-1}\}$); for $n < d \Leftrightarrow 1$ the simple modules are induced from the (well defined) subset of modules for which $\mathcal{I}(\lambda) \in \tilde{\Gamma}_n$.*

The Bratteli diagram for $\hat{P}_*(d)$ is the truncation of the P_* (generic) diagram illustrated in Figure 4 to $\mathcal{I}(\Gamma_d)$ on P_n layers and $\mathcal{I}(\Gamma_{d-1})$ on P_{n+} layers. More precisely, this is the case for $n \geq d \Leftrightarrow 1$; while for $n < d \Leftrightarrow 1$ only the vertices $\mathcal{I}(\Gamma_d) \cap \tilde{\Gamma}_n$ (resp. $\mathcal{I}(\Gamma_{d-1}) \cap \tilde{\Gamma}_n$) survive.

N.B.: The edges thus determined from Proposition 1 on the vertices $\Gamma_d \cup \Gamma_{d-1}$ (i.e. by looking at the first rows of the diagrams as well) exactly match those of \mathfrak{S}_d described at the end of Section 1.1.

Thus

$$\dim(\mathcal{S}_{\mathcal{I}(\lambda)}^d(n)) = |D_{(d),\lambda}^{\mathfrak{S}_d}(2n)| =: D(2n, \lambda) \quad \lambda \in \Gamma_d, \tag{6}$$

$$\dim(\mathcal{S}_{\mathcal{I}(\lambda)}^d(n+)) = |D_{(d),\lambda}^{\mathfrak{S}_d}(2n+1)| =: D(2n+1, \lambda) \quad \lambda \in \Gamma_{d-1},$$

yielding

$$|\mathbb{E}_{\underline{n} \cup \underline{n}'}^{\leq d}| = \sum_{\lambda \in \Gamma_d} (D(2n, \lambda))^2 = |D_{(d),(d)}^{\mathfrak{S}_d}(4n)|$$

and

$$|\mathbb{E}_{\underline{2n+1}}^{\leq d}| = \sum_{\lambda \in \Gamma_{d-1}} (D(2n+1, \lambda))^2 = |D_{(d),(d)}^{\mathfrak{S}_d}(4n+2)|$$

cf. $n! = \sum(\text{irreducible dimension})^2$ in the symmetric group case.

3. The correspondence

Having established the existence and required properties of a correspondence between \mathbb{E}_r^d and W_r^d , for any positive integers d, r , we now construct it. We do this iteratively on d . The strategy is to show that \mathbb{E}_r^d and W_r^d can be built recursively from $\{\mathbb{E}_s^{d-1} | s \in \underline{r} \Leftrightarrow 1\}$ and $\{W_s^{d-1} | s \in \underline{r} \Leftrightarrow 1\}$ respectively. In the following, we will give these recursions; it will then appear clearly that they are identical, yielding a common structure for \mathbb{E}_r^d and W_r^d . The basis is the correspondence at $d = 1$; it is forced, since \mathbb{E}_r^1 and W_r^1 have only one element.

Note that if $d > r$ both \mathbb{E}_r^d and W_r^d are empty sets, so we assume in the following $2 \leq d \leq r$ ($d = 1$ is known).

We first exhibit the structure of \mathbb{E}_r^d , defining a new filtration.

DEFINITION 1. *The chain adjacency number of a partition of \underline{r} is given by*

$$N : \mathbb{E}_{\underline{r}} \rightarrow \{0, 1, \dots, r \Leftrightarrow 1\},$$

$$N : x \mapsto |\{i \in \underline{r} \Leftrightarrow 1 \mid i \sim^x i + 1\}|,$$

then

$$\mathbb{E}_{\underline{r}}^{d,(m)} := \{x \in \mathbb{E}_{\underline{r}}^d \mid N(x) = m\}.$$

(17) For $x \in \mathbb{E}_{\underline{r}}$ write $i <^x j$ if $i < j$ and $i \sim^x j$ and $\nexists k$ such that $i < k < j$ and $i \sim^x k$.

LEMMA 1. *There is a bijection*

$$\mathfrak{U} : \mathbb{E}_{\underline{r}}^{d,(0)} \xrightarrow{\sim} \mathbb{E}_{\underline{r-1}}^{d-1}$$

given by

$$x \mapsto y \quad \text{such that } i <^y j \Leftrightarrow i <^x j + 1.$$

N.B.: The number of parts of $\mathfrak{U}(x)$ is one fewer than that of x .

Let us consider the following example: $x = \{\{1, 3\}, \{2, 4\}\}$. Its chain adjacency number is zero, so $x \in \mathbb{E}_{\underline{4}}^{2,(0)}$ and $\mathfrak{U}(x) = \{\{1, 2, 3\}\}$.

(18) Define $\Lambda_n(m)$ as the set of *weights* of length n , degree m , i.e. sequences $k = (k_1, k_2, \dots, k_n)$ of non-negative integers such that $\sum_i k_i = m$.

(19) Let x be any reflexive relation, then $T(x)$ is the transitive symmetric closure. Let relations $\mathfrak{C}_0, \mathfrak{C}_1 \subset \mathbb{N} \times \mathbb{N}$ be $\{(1, 1), (2, 2), \dots, (i, i), \dots\}$ and $\{(1, 2), (2, 3), \dots, (i, i + 1), \dots\}$ and let $\mathfrak{C} = \mathfrak{C}_0 \cup \mathfrak{C}_1$. The *comb of Rollet* takes a partition x and expresses it as a pair $(y, T(x \cap \mathfrak{C}))$ where y is the partition of the parts of $T(x \cap \mathfrak{C})$ (in the natural order) corresponding to x . Note that $y \cap \mathfrak{C}_1 = \emptyset$, and that $T(x \cap \mathfrak{C})$ is determined by the sequence of lengths of its parts in the natural order. For example, the comb takes $x = \{\{1, 3, 4\}, \{2, 5, 6, 7\}\}$ to $(\{\{1, 3\}, \{2, 4\}\}, \{\{1\}, \{2\}, \{3, 4\}, \{5, 6, 7\}\})$. Thus

LEMMA 2. *For $m \in \{0, 1, \dots, r \Leftrightarrow 1\}$ there is a bijection*

$$\mathfrak{V} : \mathbb{E}_{\underline{r}}^{d,(m)} \xrightarrow{\sim} \mathbb{E}_{\underline{r-m}}^{d,(0)} \times \Lambda_{r-m}(m)$$

given by

$$\mathfrak{V} : x \mapsto (y, (k_1, \dots, k_{r-m}))$$

as above, where $k_i + 1$ is the length of the i th part of $T(x \cap \mathcal{C})$.

For $x = \{\{1, 3, 4\}, \{2, 5, 6, 7\}\}$ in $\mathbb{E}_{\underline{2}}^{2,(3)}$ one gets $\mathfrak{B}(x) = (\{\{1, 3\}, \{2, 4\}\}, (0, 0, 1, 2))$.

We can now summarize the recursive structure of the set of partitions of \underline{r} in d parts.

THEOREM 1. For d and r two positive integers, $r \geq d > 1$,

$$\mathbb{E}_{\underline{r}}^d = \bigcup_{m=0}^{r-1} \mathbb{E}_{\underline{r}}^{d,(m)}$$

defines a partition of $\mathbb{E}_{\underline{r}}^d$ and for $m \in \{0, 1, \dots, r \Leftrightarrow 1\}$, the map

$$\mathfrak{W}: \mathbb{E}_{\underline{r}}^{d,(m)} \rightarrow \mathbb{E}_{\underline{r-m-1}}^{d-1} \times \Lambda_{r-m}(m)$$

given by $\mathfrak{W} = (\mathfrak{U} \times \text{Identity}) \circ \mathfrak{B}$ is a bijection.

Remark. If $d > r$, $\mathbb{E}_{\underline{r}}^d = \emptyset$, and if $d = 1$, $\mathbb{E}_{\underline{r}}^1 = \{\{\underline{r}\}\}$.

Let us now construct the structure of W_r^d in a parallel way.

(20) We define a certain subset of the set of possible two step subsequences of walks on the shadow graph of the P_* Bratteli diagram as follows. Let $0 \in \tilde{\Gamma}_n$ denote the empty diagram, and let $\overset{\lambda}{\square}$ denote λ with one box added on the row below the last row. Then

$$\mathfrak{T} = \{(0+, 0, 0+)\} \cup \{(\lambda+, \overset{\lambda}{\square}, \lambda+) | \lambda \neq 0\}.$$

Let us put $w(i, j)$ for the subwalk of a walk $w \in W_r^d$ corresponding to steps $i + 1, \dots, j$ (i, j two integers such that $0 \leq i < j \leq 2r$); we can now define:

DEFINITION 2.

$$U: W_r^d \rightarrow \{0, 1, \dots, r \Leftrightarrow 1\},$$

$$U: w \mapsto |\{i \in \underline{r \Leftrightarrow 1} \mid w(2i \Leftrightarrow 1, 2i + 1) \in \mathfrak{T}\}|.$$

$$W_r^{d,(m)} := \{w \in W_r^d \mid U(w) = m\}.$$

For λ a Young diagram let $p(\lambda)$ be the number of rows of λ , let $\lambda \pm \square_i$ denote adding or subtracting a box from row i , let λ_i be the number of boxes in the i th row of λ , and

$$f_\lambda(i) := \max\{j \mid \lambda_j = \lambda_i\}.$$

LEMMA 3. *There is a bijection*

$$\Omega' : W_r^{d,(0)} \xrightarrow{\sim} W_{r-1}^{d-1},$$

$$w \mapsto w',$$

where w' is obtained by suppressing the first and last steps of w and replacing, for every $l \in \underline{r} \setminus \{1\}$, the subsequence $w(2l \Leftrightarrow 1, 2l + 1)$ according to the following prescription:

D

$$\lambda^+, \lambda, (\lambda \Leftrightarrow \square_i)^+ \mapsto \lambda, (\lambda \Leftrightarrow \square_i)^+, \lambda \Leftrightarrow \square_i$$

$$\text{if } \lambda \neq 0 \quad \lambda^+, \lambda, \lambda^+ \mapsto \lambda, (\lambda \Leftrightarrow \square_{f_\lambda(1)})^+, \lambda$$

$$\lambda^+, \lambda + \square_i, (\lambda + \square_i)^+ \mapsto \lambda, \lambda^+, \lambda + \square_i$$

$$\text{if } i \neq j \quad \lambda^+, \lambda + \square_i, (\lambda + \square_i \Leftrightarrow \square_j)^+ \mapsto \lambda, (\lambda \Leftrightarrow \square_j)^+, \lambda + \square_i \Leftrightarrow \square_j$$

$$\text{if } i \notin \{1, p(\lambda) + 1\} \quad \lambda^+, \lambda + \square_i, \lambda^+ \mapsto \lambda, (\lambda \Leftrightarrow \square_{f_\lambda(i)})^+, \lambda$$

$$\lambda^+, \lambda + \square_1, \lambda^+ \mapsto \lambda, \lambda^+, \lambda.$$

The following figure sketches the different possibilities for a two step walk between either two elements of $\tilde{\Gamma} := \tilde{\Gamma}_\infty$ or of $\tilde{\Gamma}_+ := \tilde{\Gamma}_{\infty+}$. To be precise, this figure illustrates the example in which $\lambda = (4, 3, 1)$.

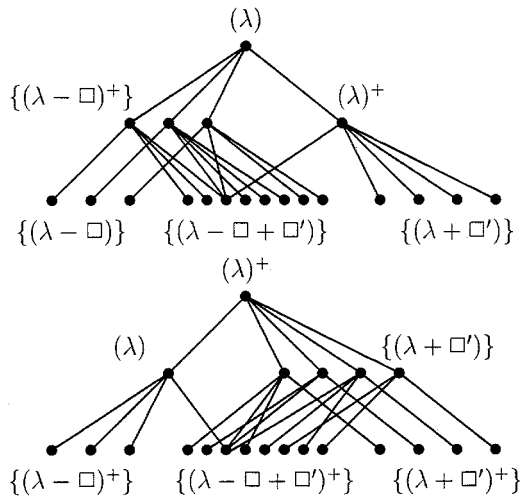

A direct check proves that all possible subsequences $w(2i \Leftrightarrow 1, 2i + 1)$ of an element of $W_r^{d,(0)}$ have been considered, and that the various right-hand sides are well defined and distinct, and that the map is surjective. In particular, if $q(w(i, j))$ is the minimal value of d for which, via \mathcal{T} , the subwalk $w(i, j)$ corresponds to a walk of \mathfrak{G}_d , one sees that for any $i \in \underline{r \Leftrightarrow 1}$:

$$q(D(w(2i \Leftrightarrow 1, 2i + 1))) = q(w(2i \Leftrightarrow 1, 2i + 1)) \Leftrightarrow 1$$

so

$$q(\mathfrak{U}'(w)) = q(w) \Leftrightarrow 1.$$

For example $w = (0, 0^+, \square, 0^+, \square, 0^+, \square, 0^+, 0) \in W_4^{2,(0)}$ gives $\mathfrak{U}'(w) = (0, 0^+, 0, 0^+, 0, 0^+, 0)$. In this case $q(w) = 2$ and $q(\mathfrak{U}'(w)) = 1$ (recall that $\Gamma_0 = \{0\}$).

We may encode a walk w as a pair (z, k) where z is the walk obtained from w by removing all those adjacent pairs of steps which appear in \mathfrak{T} , and k_i is the number of distinct pairs in the i th continuous chain of removed steps (*counting* chains of length zero). Note that the length k_i of the i th removed part contains enough information, since \mathfrak{T} is in one to one correspondence with $\tilde{\Gamma}_+$. Therefore

LEMMA 4. *There is a bijection for any $m \in \{0, 1, \dots, r \Leftrightarrow 1\}$*

$$\mathfrak{B}': W_r^{d,(m)} \xrightarrow{\sim} W_{r-m}^{d,(0)} \times \Lambda_{r-m}(m),$$

given by

$$\mathfrak{B}': w \mapsto (z, (k_1, \dots, k_{r-m})).$$

Where z is obtained from w as described above and $2k_i$ is the number of steps in the i th extracted part, also as above:

$$k_i = \max \left\{ l \in \mathbb{N}_0 \mid w \left(2i + 2 \sum_{j=1}^{i-1} k_j + 2\alpha \Leftrightarrow 1, 2i + 2 \sum_{j=1}^{i-1} k_j + 2\alpha + 1 \right) \in \mathfrak{T} \forall 0 \leq \alpha \leq l \Leftrightarrow 1 \right\}$$

The Figure below illustrates the steps which may be removed (dotted lines) at level $w(7, 9)$.

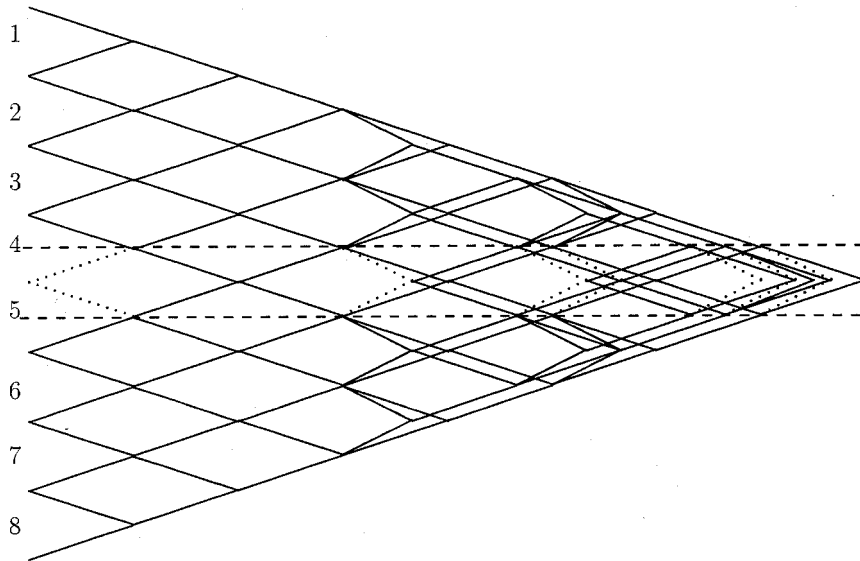

For instance, $w = (0, 0^+, \square, 0^+, \square, 0^+, 0, 0^+, \square, 0^+, 0, 0^+, 0, 0^+, 0, 0^+, 0)$ yields

$$\mathfrak{W}'(w) = ((0, 0^+, \square, 0^+, \square, 0^+, \square, 0^+, 0), (0, 0, 1, 2)).$$

THEOREM 2. For d and r two positive integers, $r \geq d > 1$,

$$W_r^d = \bigcup_{m=0}^{r-1} W_r^{d,(m)},$$

defines a partition of W_r^d and for $m \in \{0, 1, \dots, r \ominus 1\}$, the map

$$\mathfrak{W}' : W_r^{d,(m)} \rightarrow W_{r-m-1}^{d-1} \times \Lambda_{r-m}(m)$$

given by $\mathfrak{W}' = (\mathfrak{U}' \times \text{Identity}) \circ \mathfrak{V}'$ is a bijection.

Remark. If $d > r$, $W_r^d = \emptyset$, and if $d = 1$, $W_r^1 = \{(0, 0^+, 0, \dots, 0^+, 0)\}$.

We can now state the main result.

THEOREM 3. The map $\mathcal{C}_d : \mathbb{E}_r^d \rightarrow W_r^d$, $r \geq d \geq 1$, given recursively by

$$\mathcal{C}_1 : \begin{cases} \mathbb{E}_r^1 \xleftrightarrow{\sim} W_r^1 \\ \{\underline{x}\} \mapsto (0, 0^+, 0, 0^+, 0, \dots, 0^+, 0) \end{cases}$$

$$\mathcal{C}_d := (\mathfrak{W}')^{-1} \circ (\mathcal{C}_{d-1} \times \text{Identity}) \circ \mathfrak{W}$$



is a bijection.

Proof. Comparing Theorems 1 and 2 we see that, when they are not empty, \mathbb{E}_r^d and W_r^d decompose similarly. The correspondence at level d is then obtained schematically via

$$\begin{array}{ccc} \mathbb{E}_r^d = \bigcup_{m=0}^{r-1} \mathbb{E}_r^{d,(m)} & & W_r^d = \bigcup_{m=0}^{r-1} W_r^{d,(m)} \\ \downarrow & & \uparrow \\ \mathbb{E}_r^{d,(m)} \xrightarrow{\mathfrak{W}} \mathbb{E}_{r-m-1}^{d-1} \times \Lambda_{r-m}(m) \xrightarrow{\mathcal{C}_{d-1} \times \text{Id}} W_{r-m-1}^{d-1} \times \Lambda_{r-m}(m) \xrightarrow{(\mathfrak{W}')^{-1}} W_r^{d,(m)}. \end{array}$$

□

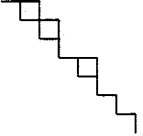
Let us now give the graphical representation of the various walks involved in some examples.

Partition	Walk
$\{\{1,3,4\}, \{2,5,6,7\}\}$	 $(0, 0^+, \square, 0^+, \square, 0^+, \square, 0^+, 0^+, 0^+, 0^+, 0)$
$\{\{1,3\}, \{2,4\}\}$	 $(0, 0^+, \square, 0^+, \square, 0^+, 0)$
$\{\{1,2,3\}\}$	 $(0, 0^+, 0, 0^+, 0)$

$$\mathcal{C}_d(\{\{1, 3, 4\}, \{2, 5, 6, 7\}\}) = (0, 0^+, \square, 0^+, \square, 0^+, 0, 0^+, \square, 0^+, 0, 0^+, 0, 0^+, 0)$$

Most of the steps needed to check this have been given as examples above; there only remains: $\mathcal{C}_1(\{\{1, 2, 3\}\}) = (0, 0^+, 0, 0^+, 0, 0^+, 0)$.

4. Physics and further motivations

The main physical interest in the partition algebra comes from its role as a master algebra for the transfer matrices of Potts models, dichromatic polynomials and Potts quantum chains in high dimensions. These are reviewed extensively elsewhere (see

[12] for details). Our correspondence may be useful in determining the primitive types of correlation function of the three-dimensional Potts models in particular. Recall that the Temperley–Lieb algebra $\mathcal{TL}_n(v)$ [24] is a transfer matrix algebra for two (or $1 + 1$)-dimensional systems, and that the algebra basis and associated models coming, in our terms, from the refined Bratelli diagram of \mathcal{TL}_* (a truncated Pascal triangle) have been very useful in analysing two-dimensional models (see [1] for instance). There is a natural inclusion of the Temperley–Lieb algebras $\mathcal{TL}_{2n}(v) \subset P_n(v)$ (and $\mathcal{TL}_{2n+1}(v) \subset P_{n+1}(v)$), and the transfer matrix algebra for three-dimensional models will also include in $P_n(v)$. The problem is that the structure of the algebra for three-dimensions has so far defied direct analysis. It is well known [11] that the *Potts quotients* of \mathcal{TL}_{2n} and P_n ($\widehat{\mathcal{TL}}_{2n}, \hat{P}_n$ resp.) are isomorphic for $v \mapsto d = 1, 2$ (and not isomorphic otherwise – although $d = 3$ is ‘essentially’ isomorphic [8]). The $v \mapsto 1$ result is trivial, but at $v \mapsto 2, 3$ the restricted Andrews–Baxter–Forrester basis (coming from the associated restricted IRF model [1]) has an obvious bijection with one of the walk sets described in the present paper. Passing through our correspondence this suggests a way to build the generators of $\hat{P}_n(2)$ in terms of those of $\widehat{\mathcal{TL}}_{2n}(2)$, and hence to build an action of $\hat{P}_n(2)$ on walks. By restriction this will give an action of the algebra for three-dimensions. The $\hat{P}_n(2)$ action should ultimately generalize to $v \mapsto$ higher d , and hence give a partial characterization of the restricted algebras and correlation functions of Potts models, in three-dimensions and beyond. This work is in progress (cf. [13, 20]).

Our correspondence may also be useful in constructing the equivalent, in the partition algebra context, of Young’s semi-normal representations of the symmetric group (recall that, given the standard Young tableaux, it was Young’s next achievement to figure out the semi-normal action [26]!). As in the Young case it seems plausible that this would give an insight into the modular theory of the algebra. Again by analogy with that case we might then expect to be able to define generalized vertex models and restricted models through these representations. Work on these areas is also in progress.

Acknowledgements

Thanks are due to ECC (HCM programme contract ERBCHBICT941607), EPSRC (grant numbers GRJ25758 and GRJ29923), Tutul Dasmahapatra and Dave Woodcock for useful discussions.

References

1. Andrews, G.E., Baxter, R.J. and Forrester, P.J.: *J. Stat. Phys.* 35 (1984) 193.
2. Baxter, R.J.: *Exactly Solved Models in Statistical Mechanics*, Academic Press, New York, 1982.
3. Brauer, R.: *Annals of Mathematics* 38 (1937) 857.
4. Goodman, F.M., de la Harpe, P. and Jones, V.F.R.: *Coxeter Graphs and Towers of Algebras*, Springer-Verlag, New York, 1989.

5. Green, J.A.: *Polynomial Representations of GL_n* , Lect. Notes in Math. 830, Springer-Verlag, Berlin, 1980, Section 6.2.
6. James, G.D. and Kerber, A.: *The Representation Theory of the Symmetric Group*, Addison-Wesley, London, 1981.
7. James, G.D. and Murphy, G.E.: *J Algebra* 59 (1979) 222.
8. Jones, V.F.R.: in *Subfactors*, H Araki et al. (eds), World Scientific, Singapore, 1994.
9. Knuth, D.: *The Art of Computer Programming Vol.3/Sorting and Searching*, Addison-Wesley, London, 1973.
10. Macdonald, I.: *Symmetric Functions and Hall Polynomials*, Oxford, 1979.
11. Martin, P.P.: *Potts Models and Related Problems in Statistical Mechanics*, World Scientific, Singapore, 1991.
12. Martin, P.P.: *R.I.M.S.*, Kyoto preprint 1022 (1995).
13. Dasmahapatra, S. and Martin, P.: *J. Phys. A* 29 (1996) 263–278.
14. Date, E., Jimbo, M. and Miwa, T.: Representations of $U_q(\mathfrak{gl}(n, C))$ at $q = 0$ and the Robinson–Schensted correspondence, in *Physics and Mathematics of Strings*, Memorial volume for Vadim Knizhnik, Brink L., D. Friedan and A.M. Polyakov, (eds), World Scientific, 1990, pp. 185–211.
15. Kirillov, A.N.: Dilogarithm Identities, *Lectures in Mathematical Sciences*, The University of Tokyo, 1995, p. 73.
16. Martin, P.P.: *Journal of Knot Theory and its Ramifications* 3 (1994) 51.
17. Martin, P.P.: The structure of the partition algebras, *Journal of Algebra* 183 (1996) 319–358.
18. Martin, P.P. and Saleur, H.: *Commun. Math. Phys.* 158 (1993) 155.
19. de B. Robinson, G.: *American J. Math.* 60 (1938) 745–760.
20. Wu, F.Y., Rollet, G., Huang, H.Y., Maillard, J.-M., Hu, C.-K. and Chen, C.-N.: Directed compact lattice animals, restricted partitions of an integer, and the infinite-state Potts model, *Phys. Rev. Lett.* 76 (1995) 173–176.
21. Rutherford, D.E. *Substitutional Analysis*, Hafner, New York, 1968.
22. Schensted, C.: *Canadian J. Math.* 13 (1961) 179–191.
23. Stanton, D. and White, D.: *Constructive Combinatorics*, Springer UTM, New York, 1986.
24. Temperley, H.N.V. and Lieb, E.: *Proceedings of the Royal Society A* (1971) 251.
25. Weyl, H.: *The Classical Groups*, Princeton, New Jersey, 1946.
26. Young, A.: On quantitative substitutional analysis IV, *Proc. L.M.S.* 34(2) (1932) 196–230.