

Assessing the disassembly performance of washing machines through the design for circular disassembly methodology

Giovanni Formentini , Thorvald Alrø Martiny, Christian Møller, Teodor Vernica and Devarajan Ramanujan

Aarhus University, Denmark

 giof@mpe.au.dk

Abstract

To enable the circular economy paradigm, it is important to design easy-to-disassemble products. A new method, known as Design for Circular Disassembly (DfCD), has been proposed to enhance product disassembly performances toward circularity. The method was tested on a small-sized product, showing promising results. However, its applicability to medium-sized products remains unclear. The goal of this article is to assess the effectiveness of DfCD on medium-sized products, particularly washing machines. Results showed DfCD can be extended to medium-sized products, increasing model complexity.

Keywords: circular economy, design for x (DfX), reparability, disassembly, product design

1. Introduction

Over the years, sustainability and circularity have come to play important roles (Voukkali et al., 2023) in industry. Beyond promoting a more sustainable lifestyle, the reduction of material and energy consumption, preservation of natural capital, and reduction of emissions play crucial roles in establishing economic systems less susceptible to sudden supply shocks (Mou et al., 2021; Sweetapple et al.; 2019; Giannetti et al., 2022). Within this context, Circular Economy (CE) is seen as a potential solution to make systems more resilient (Kennedy et al., 2022). CE is a broad concept that covers various topics and sectors, encompassing systems from production to consumption, focusing on keeping products, components, materials, and energy in circulation for as long as possible to continue adding, sustaining, and generating value (Jabbour et al., 2019). In this context, the idea of upcycling draws attention to adding value to materials that have the potential to be recirculated in the system, not only in recycled or recovered forms but also in the development of more sophisticated materials for potential recuperative and restorative returns (Triguero et al., 2023). The conceptualization and design of products is a key element for enabling the use of the circular economy paradigm in industries. Several techniques can be applied during the product development process to account for product sustainability and circularity (Wang et al., 2022). Among them, Design for Disassembly (DfD) methodologies are considered key enablers for circularity (Favi et al., 2016). The main goal of DfD methods is considering (and optimizing) product disassembly performance through the overall product development process. Disassembly performances express the ability to disassemble a product in an easy-and-fast manner, to reach one or more desired components with the least amount of time. The main drawback of current DfD methods is their poor integration with approaches for circular product design (Formentini and Ramanujan, 2023a). End-of-Life (EoL) decision-making, from a circularity perspective, requires considering the EoL status of a product and the impacts it has on the disassembly process. To address this knowledge gap, a method called Design for Circular Disassembly (DfCD) was proposed by

[Formentini and Ramanujan \(2023b\)](#). The method consists of four steps to assess a product in terms of circularity and disassembly efficiency, and identifying design drawbacks that may jeopardize the product's circularity potential at its EoL. The method introduced two novel concepts: i) a new way of modelling disassembly processes, through the Parent-Action-Child model, and ii) the concept of Disassembly Failures as product failures that have a direct impact on the disassembly process and consequently impact product circularity. The method was tested on a simple consumer appliance, i.e., an electric kettle. Even though it showed interesting results, its application to larger and more complex case studies is unclear, leaving the idea that the DfCD method might be a pure academic exercise. Moreover, it lacks a rigorous definition of disassembly time estimation. In the proposed DfCD methodology the disassembly time was computed using the MOST technique ([Zandin, 2002](#)). Even though the MOST technique is beneficial for assessing time for generic actions, including disassembly actions, it is not clear if it can be used to accurately evaluate the disassembly time for complex engineered products with a higher number of parts and more intricate disassembly operations. The aim of this article is to: i) provide further validation of the DfCD methodology by applying it to large and complex products, in particular four washing machines, in order to identify components and actions that can jeopardize the harvesting of target components (i.e., components that are of interest for economic reasons) at their EoL, ii) provide a rigorous definition of how disassembly time can be estimated, and iii) identify further results that the DfCD method can provide when products with complex disassembly sequences are studied. In particular, the article focuses solely on analysing the Disassembly Effort Index (DEI), without considering the Circularity Index (CI), to limit the analysis boundaries. Results show that the DfCD methodology can be used on large and complex products, to identify product design shortcomings that can jeopardize its disassembly at EoL. Moreover, it enables the identification of limitations in terms of disassembly information and reparability performance. The remainder of this article is organized as follows: Section 2 will briefly present the DfCD methodology, providing an overview of the approach used to apply it to complex engineered products. Section 3 details the application of the method to four washing machines. Section 4 presents results and discussions from the case study. Section 5 concludes the article.

2. Design for Circular Disassembly applied to large and complex products

Design for Circular Disassembly (DfCD) is a method aimed at identifying shortcomings in product design related to disassembly efforts that could compromise the overall product circularity performance ([Formentini and Ramanujan, 2023b](#)). The DfCD method differs from traditional DfD methodologies since it enables the consideration of failures that the product might have at its End of Life, looping it back at the design phase to enable the optimization of the product toward circularity. Indeed, traditional DfD methods do not consider the EoL phase, but aim to improve disassembly performances based on ideal (or perfect) product conditions, providing limited insights for enabling the Circular Economy paradigm ([Formentini and Ramanujan, 2023b](#)). The DfCD method follows a four-step approach to assist designers and engineers in evaluating selected products by computing two indicators: i) Disassembly Effort Index (DEI) and ii) Circularity Index (CI). This paper solely focuses on the computation of the DEI. The DfCD method introduced a novel approach to model disassembly information called the Parent-Action-Child (PAC) model. The PAC model involves defining disassembly units known as PAC units. Each PAC unit comprises one parent, one disassembly action, and one or more children. The parent represents the component intended for disassembly, the action is the necessary step to successfully disassemble the component, and the child(ren) represent the result of the disassembly process. If desired, children can undergo further disassembly to progress through the disassembly process. The novelty of the PAC model with respect to other modelling approaches lies in: i) its ability to represent the entire disassembly process considering the effects of the product's EoL (i.e., disassembly failures); ii) the possibility to clearly identify and point to disassembly actions and their consequences, iii) the possibility to represent and create a graph in a direct manner (PAC graph), to help users visualize the overall disassembly process and iv) the ability to provide a standard manner to identify components and elements in a product disassembly process, through the classes Parent, Action and Child. Figure 1

provides an overview of the DfCD method. For further information, interested readers can refer to [Formentini and Ramanujan \(2023b\)](#).

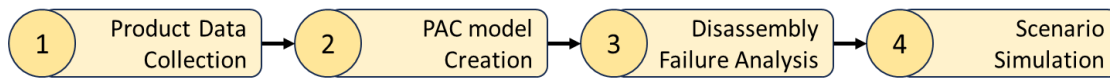

Figure 1. Steps in the Design for Circular Disassembly method

To successfully apply the DfCD methodology and compute the DEI, it is required to know the disassembly path of the analysed product. It represents the steps and actions required to perform the disassembly of the product. It can be provided as a list of actions or steps that need to be performed, or it can be provided as a graph. Moreover, information regarding target components is required. They are components that are of interest to be recovered at the product EoL. This information is collected in the first step of the method: Product Data Collection. This information can be obtained through direct inquiries to the manufacturer, it can be derived through automatic techniques (Guo et al., 2015) or it can be assumed using technical drawing. On the other hand, target components can be identified based on the component functions, material composition and so on. The second step consists of creating the PAC model. To do so, information collected during the disassembly experiment are inputted following the definition of Parent, Action, and Child. This allows the creation of the PAC model structure. Using the created PAC model, it is possible, if desired, to derive the PAC graph to visualize the overall product disassembly structure. The third step consists of the analysis of the Disassembly Failures (DFs). DFs represent failures that can have a direct impact on the disassembly process. DFs can be derived with the help of product experts, through brainstorming sessions, and if documentation is available, through the analysis of previous product failures. If documentation is lacking, the DFs can be retrieved during the disassembly process by analysing the issues and failures encountered by the operator. In fact, being that products are collected at their EoL, they present different conditions. Failures presented were collected and stored for further analysis.

3. Case study

The DfCD method was tested on four washing machines collected at their EoL, presenting different degrees of degradation. In particular, missing parts and external conditions were examined. The washing machine functionality was not tested (Figure 2). The washing machines were obtained from a local recycling company. To apply the DfCD method to a washing machine, it was essential to identify target components. Indeed, even if the method can be applied to analyse the full disassembly of product ([Formentini and Ramanujan, 2023b](#)), due to the large and complex structure of the analysed products, we decide to focus our analysis only on components that are valuable to harvest at their end-of-life, with their value being either linked to function (e.g., desired for repair purposes, ability to serve as spare part, etc.) or material (e.g., critical raw materials or valuable materials important for the industry). To define target components for washing machines, we sought support from expert engineers in the field of washing machine design. The identified target components were: 1) Control Unit, 2) Main Motor, and 3) Inner Tube. These elements are depicted in Figure 3 for a generic washing machine. In our case study, the disassembly path for the washing machines was not available, thus, to proceed with the application of the method we had to assume it. To do so, we analysed the general product drawings (i.e., not the one for our specific product) available online to gain a general understanding of washing machines architecture. Then, we assumed a feasible disassembly path for our washing machines. The hypothesized disassembly path was tested on the products, deriving disassembly steps and actions. We assumed that the derived disassembly steps and actions were the only ones possible. Even though this is a strong assumption, we believe that this resembles real conditions in professional disassembly facilities.

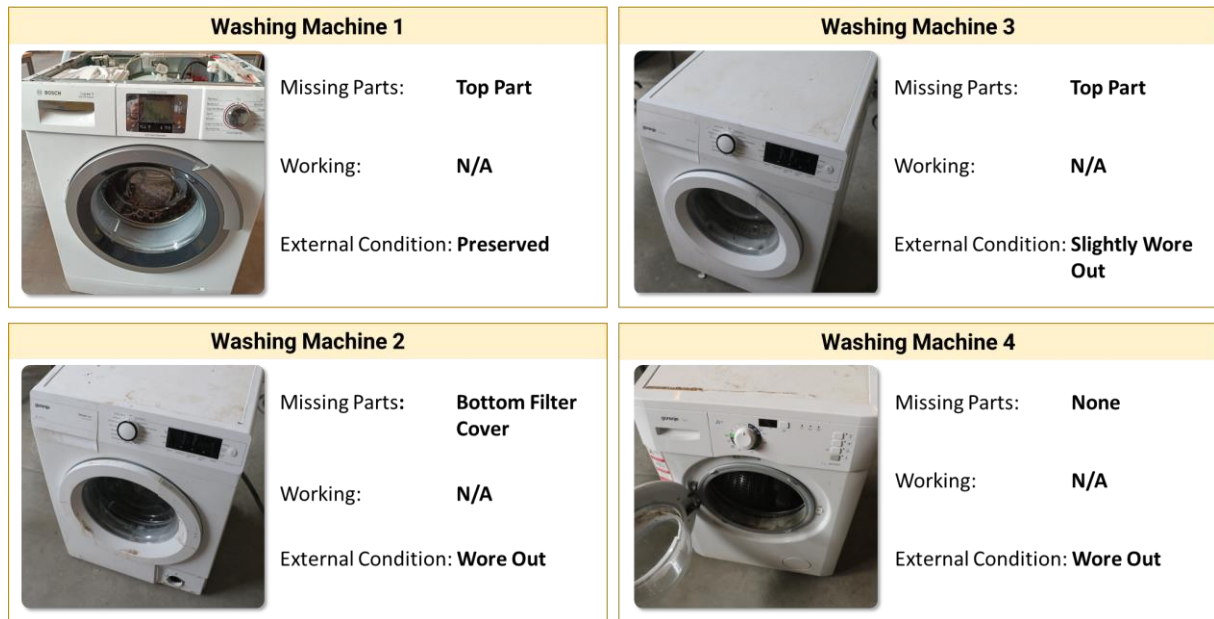

Figure 2. Washing machines condition; Each washing machine presents different EoL conditions

To perform the disassembly, we developed a disassembly protocol to ensure the accuracy of the results. The layout of the disassembly test bed is presented in Figure 4. The aim of the disassembly protocol is to execute disassembly actions and collect information to apply the DfCD method in a standardized manner, facilitating the parameterization of these actions through the MOST approach. The disassembly protocol consists of 13 steps. Actions can be: i) mandatory, ii) to perform if a Disassembly Action (DA) is successful, and iii) to perform if a DA fails. The overall protocol can require more or less time to be performed, based on the status of a DA. The protocol is summarized in Figure 5. The application of the disassembly protocol allowed us to parametrize actions performed to disassemble the products, and to model the overall disassembly time with the MOST technique.

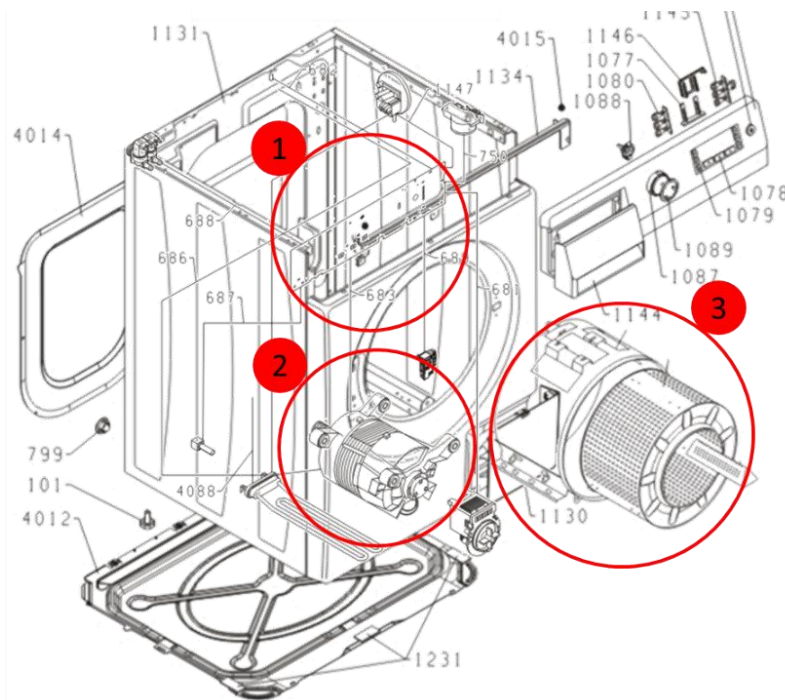

Figure 3. Target components for a generic washing machine: 1) Control Unit; 2) Main Motor; 3) Inner Tube (Source: www.how-to-repair.com)

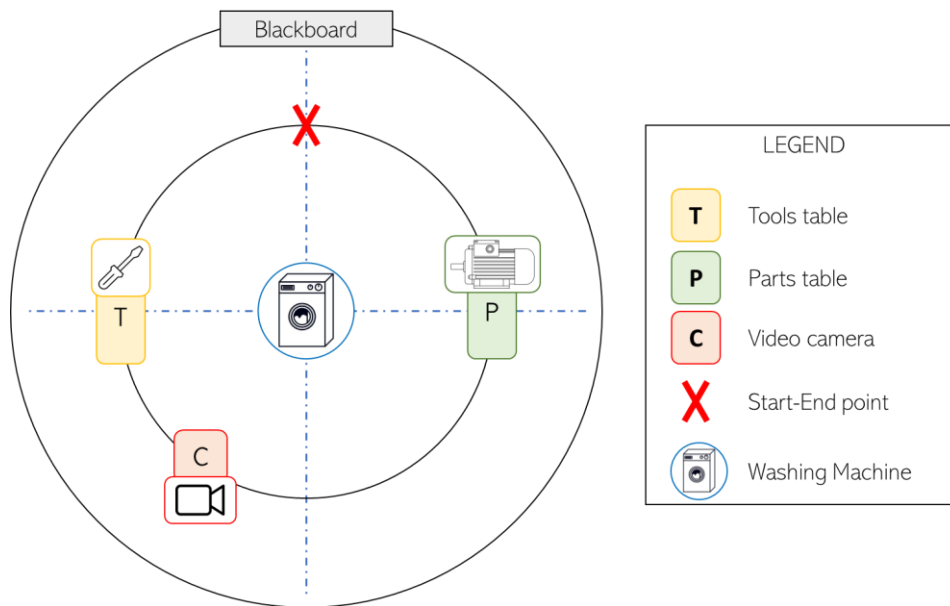

Figure 4. Disassembly test bed layout: Tool table (T): Contains standard disassembly tools; Parts table (P): Is used to place disassembled parts; Red Cross (X): Represents the starting and ending point of the disassembly action; Video camera (C): Is used to register disassembly time; Tables, Start-End point, and Video camera were placed 1 meter from the washing machine, while the Blackboard 1.5 meter

STEP	ACTION
1	Start at the marked cross, 1-meter away from the washing machine.
2	Walk towards the product to determine the necessary tool.
3	Walk to the tools table and pick up the required tool.
4	Walk to the washing machine and perform the disassembly action.
5 -s	Walk to the tools table and leave the tool.
6 -s	Walk to the washing machine and pick up the component.
7 -f	Walk to the tools table, leave the tool, and pick up alternative tool to solve the failure.
8 -f	Walk to the washing machine and resolve the disassembly failure.
9 -f	Walk to the tools table and leave the tool.
10 -f	Walk to the washing machine and pick up the component.
11 -f	Walk to the parts table and leave the component.
12	Check the blackboard to confirm if the desired target component was reached.
13	Walk to the marked cross to finish the disassembly operation.

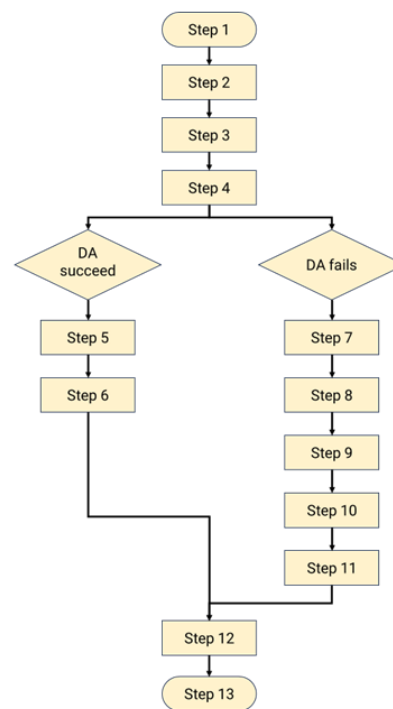

Figure 5. Disassembly protocol overview; Steps marked with “-s” must be performed if the DA is successful, steps marked with “-f” must be performed if the DA fails

Finally, once all required pieces of information such as target components, disassembly steps, and disassembly actions were collected, we created the PAC model with the support of a spreadsheet. Moreover, the PAC graph was created by hand, with the support of a drawing tool. An extract of the PAC graph for Washing Machine 1 is shown in Figure 6, created from the corresponding PAC model. Pictures have been attached for improved comprehension. The Disassembly Failure Analysis phase was performed based on the failures identified during the experiment. In particular, during the disassembly,

three (3) failures occurred, impacting the overall disassembly time. These failures required special tools and actions for resolution. Table 1 details the encountered disassembly failures. The presented failures increase the overall product disassembly time and reduce the potential for recovering target components. Specifically, the disassembly of the target component 'Control Board' necessitated a destructive disassembly step, irreversibly damaging the component and rendering it suitable only for recycling (e.g., not for reuse). We assumed a single disassembly path to calculate the disassembly time, given the absence of information about disassembly steps. Additionally, we measured disassembly time using two different techniques: direct measurement using a stopwatch and the modified MOST method (Zadin, 2002). The former was employed to determine the actual disassembly time, encompassing the time taken to perform the disassembly of components. The latter was used to model disassembly time based on disassembly actions and failures, enabling further analysis of the disassembly process.

4. Result and discussion

The DEI for the four washing machines was obtained with two different approaches. The first approach was measuring the disassembly time required to perform disassembly actions during the disassembly experiment. This is represented as the *Real Time* since it expresses the overall time spent by the operator to disassemble the product including time spent to solve disassembly failures, thinking time to perform disassembly actions, etc. The second approach consisted of modelling the disassembly time using the MOST method. This is presented as *Modelled Time* and represented the time required to perform the product disassembly in a perfect scenario (i.e., without disassembly failures and with ideal thinking time). The *Real Time* and *Modelled Time* are shown in Figure 7. It is interesting to note that the overall real disassembly time decreases from the first washing machine to the final one, even if all washing machines presented different architectures and complexities. Two main reasons contribute to this trend. Firstly, the complexity of the disassembly process decreases for each individual washing machine. This variation is inherent to the differences between the washing machines. This difference becomes apparent when examining the *Modelled Time*: 4043 seconds for the first washing machine as opposed to 2237 seconds for the last one. Since the *Modelled Time* relies on a model that does not account for operator abilities, the decrease in *Modelled Time* correlates with the reduction in overall washing machine disassembly complexity. When comparing *Modelled Time* to *Real Time*, it is evident that the latter decreases at a higher rate. This is attributed to the increase in operator experience over time. Indeed, the operator gains experience from the first to the last washing machine, requiring less time to complete the disassembly process. Zooming in on a single washing machine, the overall DEI time can be categorized into three categories: i) Time spent thinking, ii) Time spent disassembling, and iii) Time spent filling out information in the PAC model. Figure 8 presents these times for Washing Machine 1. It should be noted that the most significant difference between the modelled and the real time is attributed to the disassembly time and thinking time. This discrepancy arises from the fact that in the *Modelled Time*, disassembly failures are accounted for as an ideal scenario. However, addressing disassembly failures often requires a longer period, especially if these have not been encountered before (resulting in an increase in thinking time). This pattern is observed consistently across all disassembled washing machines. Another consideration is the time to fill instructions. This time highly affects the overall DEI in a negative manner (i.e., increase of DEI). However, among the three categories, it is the only one that can be highly reduced with the support of software automation. In particular, the creation of a tool able to harvest information from product drawings (e.g., CAD, etc.) can drastically reduce the filling time, avoiding the need of manual input. Table 2 presents the Disassembly Effort Index (DEI) and Disassembly Failure time for the various actions in the second Washing Machine PAC model. It is interesting to note that actions with ID 6A1-5C3 and 14A1-13C2 have the highest modelled DEI. In other words, these actions, if performed by a skilled operator with a perfect product (i.e., without any disassembly failure), would require the most time. This is typically the case when products are repaired under warranty. To enhance the product's reparability, it is crucial to focus on optimizing these actions. Another noteworthy result is evident in the actual disassembly time, particularly for actions 4A1-3C2 and 14A1-13C2. These actions required the longest time to be performed in practice. This can be attributed to the lack of information in the disassembly process. The time spent thinking and performing the actions contributes to an overall increase in disassembly time.

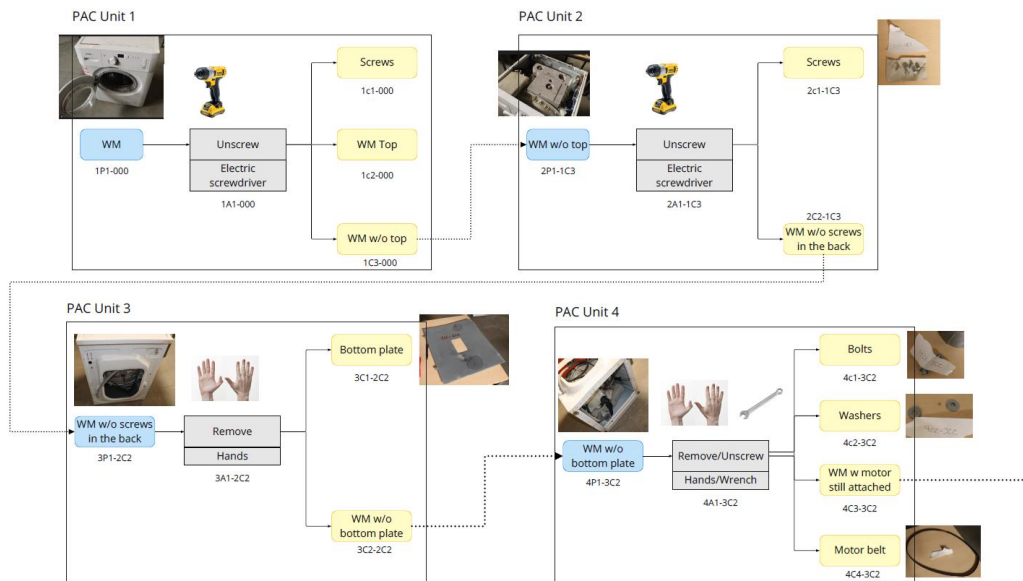

Figure 6. Extract of the PAC graph for Washing Machine 1

Table 1. DFs encountered during the disassembly of the four washing machines

Element ID	Element Name	Action Affected	Disassembly Failure description	Consequences	Tools required
4C1-3C2	Bolts	Unscrew	Motor does not come off after wires and bolts are removed	It is necessary to perform a semi-destructive action to remove the motor	Hammer and Angle Grinder
5C1-4C3	Screws	Unscrew	The part does not come off after removing the screws because it is connected to a wire	Using a wire cutter is necessary to remove the wire connections	Wire Cutter
5C3-4C3	Washing Machine without control board	Remove	Parts of the control board get damaged due to the high force required in pulling off wires	The control board is damaged as a result of using a wire cutter	Wire Cutter

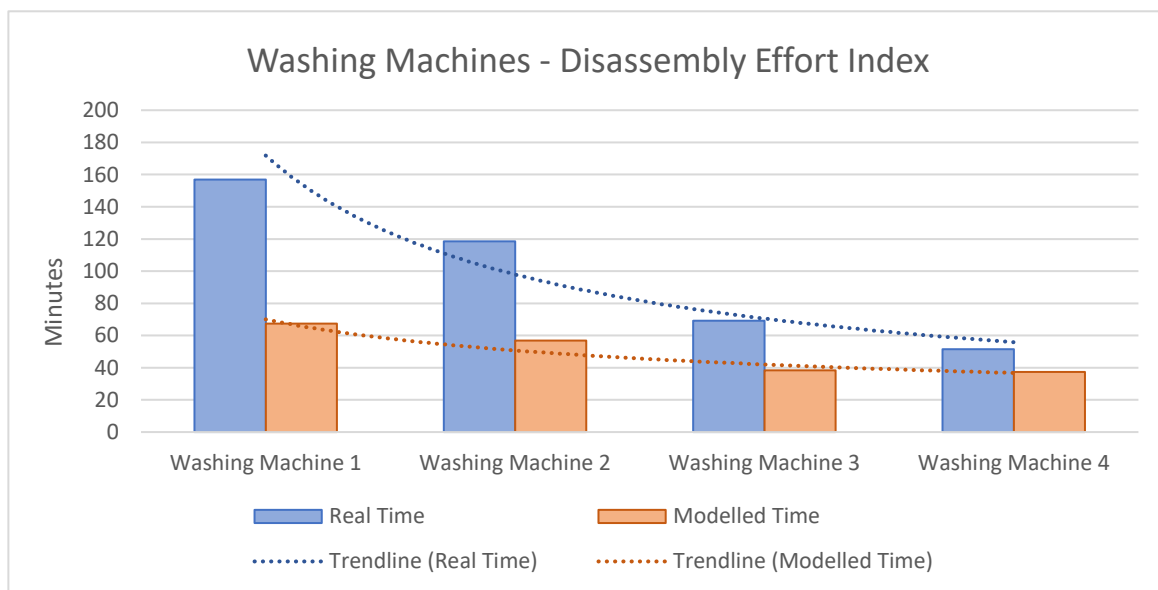

Figure 7. Washing Machine DEI; The modelled time is obtained using the modified MOST; Real time is obtained using a stopwatch

Furthermore, for action 4A1-3C2, the presence of a disassembly failure extends the overall action time by more than 500 seconds. This result suggests that providing additional information for actions 4A1-3C2 and 14A1-13C2 would be beneficial to reduce the actual disassembly time and optimize the process. It is interesting to observe that the disassembly time to resolve a disassembly failure varies significantly between the modelled and real times. This discrepancy underscores the variability of disassembly failures, emphasizing the importance of operator skills in identifying the right approach to solve a disassembly failure and save time. Lastly, it is necessary to analyse whether the MOST technique can effectively model the disassembly time for complex products. In Table 2 the error between *Real Time* and the *Modelled Time*, computed as difference between the two, divided by the *Real Time* is illustrated. Most actions exhibit a difference of over 50% between *the Real* and *Modelled Time*, meaning that *The Modelled Time is 50% lower than the Real Time*. This clearly highlights the impracticality of using the MOST technique, and consequently, the modified MOST, to model disassembly time with high accuracy. While it may not provide the exact time needed for product disassembly, it can serve as a benchmark to identify which actions should be prioritized in redesign efforts if optimizing the disassembly process is desired.

5. Conclusion and future development

In this article, we explore the application of the Design for Circular Disassembly (DfCD) methodology on medium-sized complex products. The method was employed to examine the disassembly performance of four washing machines recovered at their End-of-Life. The results demonstrated the successful application of the DfCD methodology to various case studies, aiding in the identification of design shortcomings that impact overall disassembly performance. It also facilitated the identification of redesign suggestions to enhance product reparability, allowing a deeper understanding of where product disassembly bottlenecks lie. Furthermore, the approach proved effective in identifying actions that require a higher amount of information for execution, indicating a lack of clear disassembly guidelines. One limitation of the approach is the significant amount of time required to create the PAC model and the associated PAC graph, along with the need for a skilled operator capable of applying both disassembly procedures and the DfCD methodology. As a future direction, it is essential to extend the current analysis to assess product circularity performances by computing circularity and resilience indicators. This extension will enable relating redesign suggestions to the potential circularity of the product and understanding how changes in product design can enhance manufacturer resilience. Additionally, exploring the automation of the methodology through a software tool is of interest.

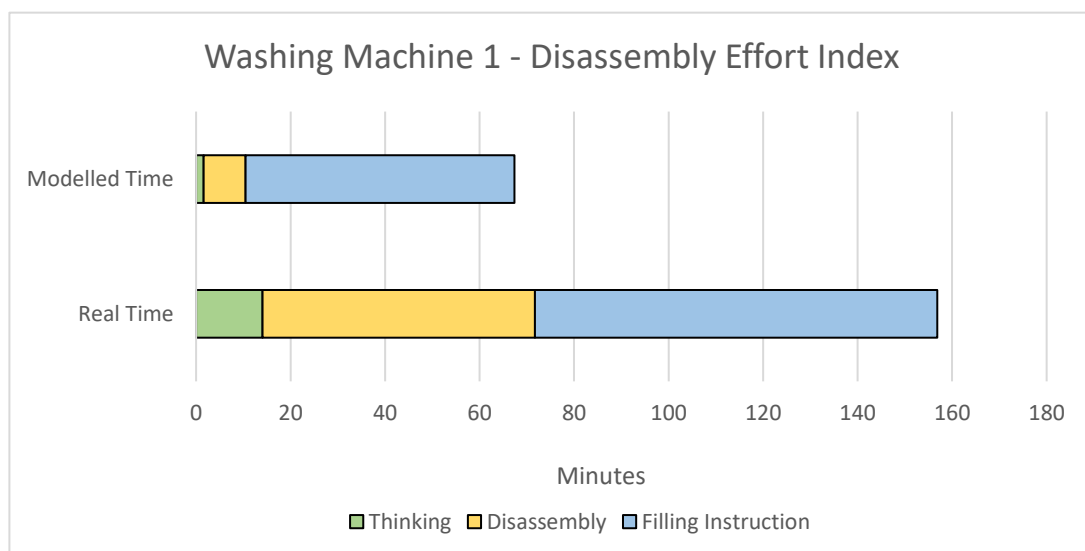

Figure 8. Disassembly effort index for Washing Machine 1; The time is divided into Thinking, Disassemble, and Filling Instruction

Such software would facilitate the overall DfCD analysis in a user-friendly manner, reducing data inputting time. Moreover, linking the software to existing computer-aided design modelling software could transition the analysis from late design phases to early design phases. However, this would necessitate the creation of a database to estimate disassembly time using real data, as highlighted in the paper, where the modelling of disassembly time was crucial for obtaining reliable results.

Table 2. PAC model for Washing Machine 2; Blue cells represent the actions with the highest modelled DEI, without DF; yellow cells represent the actions with the highest overall real DEI

Action ID	Action	Action Description	Disassembly Effort Time (DEI) - Seconds		Disassembly Failure Time - Seconds		Deviation (%)
			Modelled Time without Disassembly Failure (mMost)	Real Time (StopWatch)	Modelled Time to solve the Disassembly Failure (mMost)	Real Time to solve the Disassembly Failure (StopWatch)	
1A1-000	Unscrew	Electric screwdriver screw out screws holding the top on	4,05	6,75	0		40%
2A1-1C3	Unscrew	Electric screwdriver used for all screws on the back	3,95	4,48	0		12%
3A1-2C2	Remove	Remove bottom plate with hands	3,69	3,50	0		-5%
4A1-3C2	Remove and Unscrew	Remove electrical wires and unscrew bolts holding motor to the tube	4,23	27,83	0,13	8,50	54%
5A1-4C3	Remove and Unscrew	Remove wires and unscrew screws to get of control board	4,00	15,50	0,13	5,92	36%
6A1-5C3	Unscrew	Unscrew with hand screwdriver because electric wasn't strong enough	4,80	16,33	0		71%
7A1-6C5	Unscrew	Unscrew WM door with electric screwdriver	4,05	6,23	0		35%
8A1-7C3	Remove	Remove metal wire holded the plastic in the WM door sealed with flathead screwdriver	3,75	6,55	0		43%
9A1-8C2	Remove and Unscrew	Remove soap holder and unscrew screws behind it	4,34	6,40	0		32%
10A1-9C4	Unscrew and Wire cut	Unscrew small tube connected to the main tube and use wire cutter to remove the subassembly of the inner soap holder	4,00	7,53	0		47%
11A1-10C3	Unscrew	Use screwdriver to get out 4 small screws and wrench to get out 2 bolts to unfasten the suspension	4,05	14,25	0		72%
12A1-11C3	Unscrew and Remove	Unscrew small tube connected to main tube and move the tube to the side	3,45	4,30	0		20%
13A1-12C1	Remove	Remove springs	3,76	4,72	0		20%
14A1-13C2	Unscrew and Remove	Unscrew second cement block and move the main tube out of the WM chassis	4,81	17,63	0		73%

Acknowledgement

This paper is supported by European Union's Horizon 2020 research and innovation program under grant agreement No. 958448, project CircThread (Building the Digital Thread for Circular Economy Product, Resource & Service Management). The findings and opinions stated in this paper reflect the opinion of the authors and not the opinion of the European Commission

References

- Voukkali, I., Papamichael, I., Economou, F., Pantelitsa Loizia, Eleftheria Klontza, Lekkas, D., Naddeo, V. and Zorpas, A.A. (2023). Factors affecting social attitude and behavior for the transition towards a circular economy. *Sustainable Chemistry and Pharmacy*, 36, pp.101276–101276. <https://doi.org/10.1016/j.scp.2023.101276>.
- Mou, Y., Luo, Y., Su, Z., Wang, J. and Liu, T. (2021). Evaluating the dynamic sustainability and resilience of a hybrid urban system: case of Chengdu, China. *Journal of Cleaner Production*, 291, p.125719. <https://doi.org/10.1016/j.jclepro.2020.125719>.
- Sweetapple, C., Fu, G., Farmani, R. and Butler, D. (2019). Exploring wastewater system performance under future threats: Does enhancing resilience increase sustainability? *Water Research*, 149, pp.448–459. <https://doi.org/10.1016/j.watres.2018.11.025>.
- Giannetti, B.F., Diaz Lopez, F.J., Liu, G., Agostinho, F., Sevegnani, F. and Almeida, C.M.V.B. (2023). A resilient and sustainable world: Contributions from cleaner production, circular economy, eco-innovation, responsible consumption, and cleaner waste systems. *Journal of Cleaner Production*, [online] 384, p.135465. <https://doi.org/10.1016/j.jclepro.2022.135465>.

- Kennedy, S. and Linnenluecke, M.K. (2022). Circular economy and resilience: A research agenda. *Business Strategy and the Environment*, 31(6). <https://doi.org/10.1002/bse.3004>.
- Jabbour, C.J.C., Jabbour, A.B.L. de S., Sarkis, J. and Filho, M.G. (2019). Unlocking the circular economy through new business models based on large-scale data: An integrative framework and research agenda. *Technological Forecasting and Social Change*, 144(1), pp.546–552. <https://doi.org/10.1016/j.techfore.2017.09.010>.
- Triguero, Á., Moreno-Mondéjar, L. and Sáez-Martínez, F.J. (2023). Circular economy and firm performance: The influence of product life cycle analysis, upcycling, and redesign. *Sustainable Development*. <https://doi.org/10.1002/sd.2509>.
- Wang, J.X., Burke, H. and Zhang, A. (2022). Overcoming barriers to circular product design. *International Journal of Production Economics*, 243, p.108346. <https://doi.org/10.1016/j.ijpe.2021.108346>.
- Favi, C., Germani, M., Luzi, A., Mandolini, M. and Marconi, M. (2017). A design for EoL approach and metrics to favour closed-loop scenarios for products. 10(3), pp.136–146. <https://doi.org/10.1080/19397038.2016.1270369>.
- Formentini, G. and Devarajan Ramanujan (2023a). EXAMINING THE ROLE AND FUTURE POTENTIAL OF DESIGN FOR DISASSEMBLY METHODS TO SUPPORT CIRCULAR PRODUCT DESIGN. *Proceedings of the Design Society*, 3, pp.1735–1744. <https://doi.org/10.1017/pds.2023.174>.
- Formentini, G. and Devarajan Ramanujan (2023b). Design for circular disassembly: Evaluating the impacts of product end-of-life status on circularity through the parent-action-child model. *Journal of Cleaner Production*, 405, pp.137009–137009. <https://doi.org/10.1016/j.jclepro.2023.137009>.
- Zandin, K.B. (2002). *MOST Work Measurement Systems*. CRC Press eBooks. <https://doi.org/10.1201/9781482275940>.
- Formentini, G. and Ramanujan D. (2023c). Accounting For Product End-of-Life Status in Disassembly Time Estimation Using Modified Maynard Operation Sequences. *Procedia CIRP*, 116, pp.305–311. <https://doi.org/10.1016/j.procir.2023.02.052>.
- Guo, X., Liu, S., Zhou, M. and Tian, G. (2016). Disassembly Sequence Optimization for Large-Scale Products With Multiresource Constraints Using Scatter Search and Petri Nets. *IEEE transactions on cybernetics*, 46(11), pp.2435–2446. <https://doi.org/10.1109/tcyb.2015.2478486>.